

Joseph Bak
Donald J. Newman

UNDERGRADUATE TEXTS IN MATHEMATICS

Complex Analysis

Third Edition



Springer

Undergraduate Texts in Mathematics

Editorial Board

S. Axler

K.A. Ribet

Joseph Bak • Donald J. Newman

Complex Analysis

Third Edition



Springer

Joseph Bak
City College of New York
Department of Mathematics
138th St. & Convent Ave.
New York, New York 10031
USA
jbak@ccny.cuny.edu

Donald J. Newman
(1930–2007)

Editorial Board:

S. Axler
Mathematics Department
San Francisco State University
San Francisco, CA 94132
USA
axler@sfsu.edu

K. A. Ribet
Mathematics Department
University of California at Berkeley
Berkeley, CA 94720
USA
ribet@math.berkeley.edu

ISSN 0172-6056
ISBN 978-1-4419-7287-3 e-ISBN 978-1-4419-7288-0
DOI 10.1007/978-1-4419-7288-0
Springer New York Dordrecht Heidelberg London

Library of Congress Control Number: 2010932037

Mathematics Subject Classification (2010): 30-xx, 30-01, 30Exx

© Springer Science+Business Media, LLC 1991, 1997, 2010

All rights reserved. This work may not be translated or copied in whole or in part without the written permission of the publisher (Springer Science+Business Media, LLC, 233 Spring Street, New York, NY 10013, USA), except for brief excerpts in connection with reviews or scholarly analysis. Use in connection with any form of information storage and retrieval, electronic adaptation, computer software, or by similar or dissimilar methodology now known or hereafter developed is forbidden.

The use in this publication of trade names, trademarks, service marks, and similar terms, even if they are not identified as such, is not to be taken as an expression of opinion as to whether or not they are subject to proprietary rights.

Printed on acid-free paper

Springer is part of Springer Science+Business Media (www.springer.com)

Preface to the Third Edition

Beginning with the first edition of *Complex Analysis*, we have attempted to present the classical and beautiful theory of complex variables in the clearest and most intuitive form possible. The changes in this edition, which include additions to ten of the nineteen chapters, are intended to provide the additional insights that can be obtained by seeing a little more of the “big picture”. This includes additional related results and occasional generalizations that place the results in a slightly broader context.

The Fundamental Theorem of Algebra is enhanced by three related results. Section 1.3 offers a detailed look at the solution of the cubic equation and its role in the acceptance of complex numbers. While there is no formula for determining the roots of a general polynomial, we added a section on Newton’s Method, a numerical technique for approximating the zeroes of any polynomial. And the Gauss-Lucas Theorem provides an insight into the location of the zeroes of a polynomial and those of its derivative.

A series of new results relate to the mapping properties of analytic functions. A revised proof of Theorem 6.15 leads naturally to a discussion of the connection between critical points and saddle points in the complex plane. The proof of the Schwarz Reflection Principle has been expanded to include reflection across analytic arcs, which plays a key role in a new section (14.3) on the mapping properties of analytic functions on closed domains. And our treatment of special mappings has been enhanced by the inclusion of Schwarz-Christoffel transformations.

A single interesting application to number theory in the earlier editions has been expanded into a new section (19.4) which includes four examples from additive number theory, all united in their use of generating functions.

Perhaps the most significant changes in this edition revolve around the proof of the prime number theorem. There are two new sections (17.3 and 18.2) on Dirichlet series. With that background, a pivotal result on the Zeta function (18.10), which seemed to “come out of the blue”, is now seen in the context of the analytic continuation of Dirichlet series. Finally the actual proof of the prime number theorem has been considerably revised. The original independent proofs by Hadamard and de la Vallée Poussin were both long and intricate. Donald Newman’s 1980 article

presented a dramatically simplified approach. Still the proof relied on several nontrivial number-theoretic results, due to Chebychev, which formed a separate appendix in the earlier editions. Over the years, further refinements of Newman's approach have been offered, the most recent of which is the award-winning 1997 article by Zagier. We followed Zagier's approach, thereby eliminating the need for a separate appendix, as the proof relies now on only one relatively straightforward result due to Chebychev.

The first edition contained no solutions to the exercises. In the second edition, responding to many requests, we included solutions to all exercises. This edition contains 66 new exercises, so that there are now a total of 300 exercises. Once again, in response to instructors' requests, while solutions are given for the majority of the problems, each chapter contains at least a few for which the solutions are not included. These are denoted with an asterisk.

Although Donald Newman passed away in 2007, most of the changes in this edition were anticipated by him and carry his imprimatur. I can only hope that all of the changes and additions approach the high standard he set for presenting mathematics in a lively and "simple" manner.

In an earlier edition of this text, it was my pleasure to thank my former student, Pisheng Ding, for his careful work in reviewing the exercises. In this edition, it is an even greater pleasure to acknowledge his contribution to many of the new results, especially those relating to the mapping properties of analytic functions on closed domains. This edition also benefited from the input of a new generation of students at City College, especially Maxwell Musser, Matthew Smedberg, and Edger Sterjo. Finally, it is a pleasure to acknowledge the careful work and infinite patience of Elizabeth Loew and the entire editorial staff at Springer.

Joseph Bak
City College of NY
April 2010

Preface to the Second Edition

One of our goals in writing this book has been to present the theory of analytic functions with as little dependence as possible on advanced concepts from topology and several-variable calculus. This was done not only to make the book more accessible to a student in the early stages of his/her mathematical studies, but also to highlight the authentic complex-variable methods and arguments as opposed to those of other mathematical areas. The minimum amount of background material required is presented, along with an introduction to complex numbers and functions, in Chapter 1.

Chapter 2 offers a somewhat novel, yet highly intuitive, definition of analyticity as it applies specifically to polynomials. This definition is related, in Chapter 3, to the Cauchy-Riemann equations and the concept of differentiability. In Chapters 4 and 5, the reader is introduced to a sequence of theorems on entire functions, which are later developed in greater generality in Chapters 6–8. This two-step approach, it is hoped, will enable the student to follow the sequence of arguments more easily. Chapter 5 also contains several results which pertain exclusively to entire functions.

The key result of Chapters 9 and 10 is the famous Residue Theorem, which is followed by many standard and some not-so-standard applications in Chapters 11 and 12.

Chapter 13 introduces conformal mapping, which is interesting in its own right and also necessary for a proper appreciation of the subsequent three chapters. Hydrodynamics is studied in Chapter 14 as a bridge between Chapter 13 and the Riemann Mapping Theorem. On the one hand, it serves as a nice application of the theory developed in the previous chapters, specifically in Chapter 13. On the other hand, it offers a physical insight into both the statement and the proof of the Riemann Mapping Theorem.

In Chapter 15, we use “mapping” methods to generalize some earlier results. Chapter 16 deals with the properties of harmonic functions and the related theory of heat conduction.

A second goal of this book is to give the student a feeling for the wide applicability of complex-variable techniques even to questions which initially do not seem to belong to the complex domain. Thus, we try to impart some of the enthusiasm

apparent in the famous statement of Hadamard that "the shortest route between two truths in the real domain passes through the complex domain." The physical applications of Chapters 14 and 16 are good examples of this, as are the results of Chapter 11. The material in the last three chapters is designed to offer an even greater appreciation of the breadth of possible applications. Chapter 17 deals with the different forms an analytic function may take. This leads directly to the Gamma and Zeta functions discussed in Chapter 18. Finally, in Chapter 19, a potpourri of problems—again, some classical and some novel—is presented and studied with the techniques of complex analysis.

The material in the book is most easily divided into two parts: a first course covering the materials of Chapters 1–11 (perhaps including parts of Chapter 13), and a second course dealing with the later material. Alternatively, one seeking to cover the physical applications of Chapters 14 and 16 in a one-semester course could omit some of the more theoretical aspects of Chapters 8, 12, 14, and 15, and include them, with the later material, in a second-semester course.

The authors express their thanks to the many colleagues and students whose comments were incorporated into this second edition. Special appreciation is due to Mr. Pi-Sheng Ding for his thorough review of the exercises and their solutions. We are also indebted to the staff of Springer-Verlag Inc. for their careful and patient work in bringing the manuscript to its present form.

Joseph Bak
Donald J. Newmann

Contents

Preface to the Third Edition	v
Preface to the Second Edition	vii
1 The Complex Numbers	1
Introduction	1
1.1 The Field of Complex Numbers	1
1.2 The Complex Plane	4
1.3 The Solution of the Cubic Equation	9
1.4 Topological Aspects of the Complex Plane	12
1.5 Stereographic Projection; The Point at Infinity	16
Exercises	18
2 Functions of the Complex Variable z	21
Introduction	21
2.1 Analytic Polynomials	21
2.2 Power Series	25
2.3 Differentiability and Uniqueness of Power Series	28
Exercises	32
3 Analytic Functions	35
3.1 Analyticity and the Cauchy-Riemann Equations	35
3.2 The Functions e^z , $\sin z$, $\cos z$	40
Exercises	41
4 Line Integrals and Entire Functions	45
Introduction	45
4.1 Properties of the Line Integral	45
4.2 The Closed Curve Theorem for Entire Functions	52
Exercises	56

5	Properties of Entire Functions	59
5.1	The Cauchy Integral Formula and Taylor Expansion for Entire Functions	59
5.2	Liouville Theorems and the Fundamental Theorem of Algebra; The Gauss-Lucas Theorem	65
5.3	Newton's Method and Its Application to Polynomial Equations	68
	Exercises	74
6	Properties of Analytic Functions	77
	Introduction	77
6.1	The Power Series Representation for Functions Analytic in a Disc	77
6.2	Analytic in an Arbitrary Open Set	81
6.3	The Uniqueness, Mean-Value, and Maximum-Modulus Theorems; Critical Points and Saddle Points	82
	Exercises	90
7	Further Properties of Analytic Functions	93
7.1	The Open Mapping Theorem; Schwarz' Lemma	93
7.2	The Converse of Cauchy's Theorem: Morera's Theorem; The Schwarz Reflection Principle and Analytic Arcs	98
	Exercises	104
8	Simply Connected Domains	107
8.1	The General Cauchy Closed Curve Theorem	107
8.2	The Analytic Function $\log z$	113
	Exercises	116
9	Isolated Singularities of an Analytic Function	117
9.1	Classification of Isolated Singularities; Riemann's Principle and the Casorati-Weierstrass Theorem	117
9.2	Laurent Expansions	120
	Exercises	126
10	The Residue Theorem	129
10.1	Winding Numbers and the Cauchy Residue Theorem	129
10.2	Applications of the Residue Theorem	135
	Exercises	141
11	Applications of the Residue Theorem to the Evaluation of Integrals and Sums	143
	Introduction	143
11.1	Evaluation of Definite Integrals by Contour Integral Techniques	143
11.2	Application of Contour Integral Methods to Evaluation and Estimation of Sums	151
	Exercises	158

12 Further Contour Integral Techniques	161
12.1 Shifting the Contour of Integration	161
12.2 An Entire Function Bounded in Every Direction	164
Exercises	167
13 Introduction to Conformal Mapping	169
13.1 Conformal Equivalence	169
13.2 Special Mappings	175
13.3 Schwarz-Christoffel Transformations	187
Exercises	192
14 The Riemann Mapping Theorem	195
14.1 Conformal Mapping and Hydrodynamics	195
14.2 The Riemann Mapping Theorem	200
14.3 Mapping Properties of Analytic Functions on Closed Domains	204
Exercises	213
15 Maximum-Modulus Theorems for Unbounded Domains	215
15.1 A General Maximum-Modulus Theorem	215
15.2 The Phragmén-Lindelöf Theorem	218
Exercises	223
16 Harmonic Functions	225
16.1 Poisson Formulae and the Dirichlet Problem	225
16.2 Liouville Theorems for $\operatorname{Re} f$; Zeroes of Entire Functions of Finite Order	233
Exercises	238
17 Different Forms of Analytic Functions	241
Introduction	241
17.1 Infinite Products	241
17.2 Analytic Functions Defined by Definite Integrals	249
17.3 Analytic Functions Defined by Dirichlet Series	251
Exercises	255
18 Analytic Continuation; The Gamma and Zeta Functions	257
Introduction	257
18.1 Power Series	257
18.2 Analytic Continuation of Dirichlet Series	263
18.3 The Gamma and Zeta Functions	265
Exercises	271

19 Applications to Other Areas of Mathematics	273
Introduction	273
19.1 A Variation Problem	273
19.2 The Fourier Uniqueness Theorem	275
19.3 An Infinite System of Equations	277
19.4 Applications to Number Theory	278
19.5 An Analytic Proof of The Prime Number Theorem	285
Exercises	290
Answers	291
References	319
Appendices	321
Index	325

Chapter 1

The Complex Numbers

Introduction

Numbers of the form $a + b\sqrt{-1}$, where a and b are real numbers—what we call complex numbers—appeared as early as the 16th century. Cardan (1501–1576) worked with complex numbers in solving quadratic and cubic equations. In the 18th century, functions involving complex numbers were found by Euler to yield solutions to differential equations. As more manipulations involving complex numbers were tried, it became apparent that many problems in the theory of real-valued functions could be most easily solved using complex numbers and functions. For all their utility, however, complex numbers enjoyed a poor reputation and were not generally considered legitimate numbers until the middle of the 19th century. Descartes, for example, rejected complex roots of equations and coined the term “imaginary” for such roots. Euler, too, felt that complex numbers “exist only in the imagination” and considered complex roots of an equation useful only in showing that the equation actually has *no* solutions.

The wider acceptance of complex numbers is due largely to the geometric representation of complex numbers which was most fully developed and articulated by Gauss. He realized it was erroneous to assume “that there was some dark mystery in these numbers.” In the geometric representation, he wrote, one finds the “intuitive meaning of complex numbers completely established and more is not needed to admit these quantities into the domain of arithmetic.”

Gauss’ work did, indeed, go far in establishing the complex number system on a firm basis. The first complete and formal definition, however, was given by his contemporary, William Hamilton. We begin with this definition, and then consider the geometry of complex numbers.

1.1 The Field of Complex Numbers

We will see that complex numbers can be written in the form $a + bi$, where a and b are real numbers and i is a square root of -1 . This in itself is not a formal definition,

however, since it presupposes a system in which a square root of -1 makes sense. The existence of such a system is precisely what we are trying to establish. Moreover, the operations of addition and multiplication that appear in the expression $a + bi$ have not been defined. The formal definition below gives these definitions in terms of ordered pairs.

1.1 Definition

The complex field \mathbb{C} is the set of ordered pairs of real numbers (a, b) with addition and multiplication defined by

$$(a, b) + (c, d) = (a + c, b + d)$$

$$(a, b)(c, d) = (ac - bd, ad + bc).$$

The associative and commutative laws for addition and multiplication as well as the distributive law follow easily from the same properties of the real numbers. The additive identity, or *zero*, is given by $(0, 0)$, and hence the additive inverse of (a, b) is $(-a, -b)$. The multiplicative identity is $(1, 0)$. To find the multiplicative inverse of any nonzero (a, b) we set

$$(a, b)(x, y) = (1, 0),$$

which is equivalent to the system of equations:

$$ax - by = 1$$

$$bx + ay = 0$$

and has the solution

$$x = \frac{a}{a^2 + b^2}, \quad y = \frac{-b}{a^2 + b^2}.$$

Thus the complex numbers form a field.

Suppose now that we associate complex numbers of the form $(a, 0)$ with the corresponding real numbers a . It follows that

$$(a_1, 0) + (a_2, 0) = (a_1 + a_2, 0) \text{ corresponds to } a_1 + a_2$$

and that

$$(a_1, 0)(a_2, 0) = (a_1a_2, 0) \text{ corresponds to } a_1a_2.$$

Thus the correspondence between $(a, 0)$ and a preserves all arithmetic operations and there can be no confusion in replacing $(a, 0)$ by a . In that sense, we say that the set of complex numbers of the form $(a, 0)$ is isomorphic with the set of real numbers, and we will no longer distinguish between them. In this manner we can now say that $(0, 1)$ is a square root of -1 since

$$(0, 1)(0, 1) = (-1, 0) = -1$$

and henceforth $(0, 1)$ will be denoted i . Note also that

$$a(b, c) = (a, 0)(b, c) = (ab, ac),$$

so that we can rewrite any complex number in the following way:

$$(a, b) = (a, 0) + (0, b) = a + bi.$$

We will use the latter form throughout the text.

Returning to the question of square roots, there are in fact two complex square roots of -1 : i and $-i$. Moreover, there are two square roots of any nonzero complex number $a + bi$. To solve

$$(x + iy)^2 = a + bi$$

we set

$$\begin{aligned} x^2 - y^2 &= a \\ 2xy &= b \end{aligned}$$

which is equivalent to

$$\begin{aligned} 4x^4 - 4ax^2 - b^2 &= 0 \\ y &= b/2x. \end{aligned}$$

Solving first for x^2 , we find the two solutions are given by

$$\begin{aligned} x &= \pm \sqrt{\frac{a + \sqrt{a^2 + b^2}}{2}} \\ y &= \frac{b}{2x} = \pm \sqrt{\frac{-a + \sqrt{a^2 + b^2}}{2}} \cdot (\text{sign } b) \end{aligned}$$

where

$$\text{sign } b = \begin{cases} 1 & \text{if } b \geq 0 \\ -1 & \text{if } b < 0. \end{cases}$$

EXAMPLE

- i. The two square roots of $2i$ are $1 + i$ and $-1 - i$.
- ii. The square roots of $-5 - 12i$ are $2 - 3i$ and $-2 + 3i$. ◇

It follows that any quadratic equation with complex coefficients admits a solution in the complex field. For by the usual manipulations,

$$az^2 + bz + c = 0 \quad a, b, c \in \mathbb{C}, \quad a \neq 0$$

is seen to be equivalent to

$$\left(z + \frac{b}{2a}\right)^2 = \frac{b^2 - 4ac}{4a^2},$$

and hence has the solutions

$$z = \frac{-b \pm \sqrt{b^2 - 4ac}}{2a}. \quad (1)$$

In Chapter 5, we will see that quadratic equations are not unique in this respect: every nonconstant polynomial with complex coefficients has a zero in the complex field.

One property of real numbers that does not carry over to the complex plane is the notion of *order*. We leave it as an exercise for those readers familiar with the axioms of order to check that the number i cannot be designated as either positive or negative without producing a contradiction.

1.2 The Complex Plane

Thinking of complex numbers as ordered pairs of real numbers (a, b) is closely linked with the geometric interpretation of the complex field, discovered by Wallis, and later developed by Argand and by Gauss. To each complex number $a + bi$ we simply associate the point (a, b) in the Cartesian plane. Real numbers are thus associated with points on the x -axis, called the *real axis* while the purely imaginary numbers bi correspond to points on the y -axis, designated as the *imaginary axis*.

Addition and multiplication can also be given a geometric interpretation. The sum of z_1 and z_2 corresponds to the vector sum: If the vector from 0 to z_2 is shifted parallel to the x and y axes so that its initial point is z_1 , the resulting terminal point is $z_1 + z_2$. If 0, z_1 and z_2 are not collinear this is the so-called parallelogram law; see below.

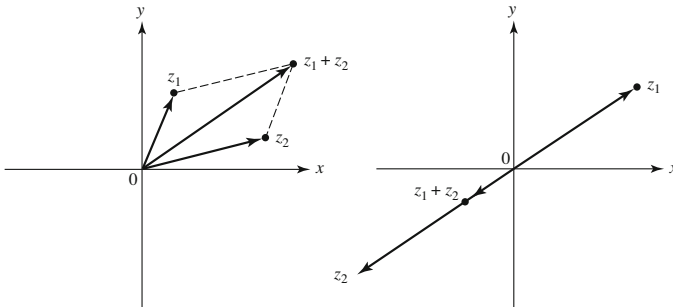

The geometric method for obtaining the product $z_1 z_2$ is somewhat more complicated. If we form a triangle with two sides given by the vectors (originating from 0 to) 1 and z_1 and then form a similar triangle with the same orientation and the

vector z_2 corresponding to the vector 1, the vector which then corresponds to z_1 will be $z_1 z_2$.

This can be verified geometrically but will be most transparent when we introduce polar coordinates later in this section. For the moment, we observe that multiplication by i is equivalent geometrically to a counterclockwise rotation of 90° .

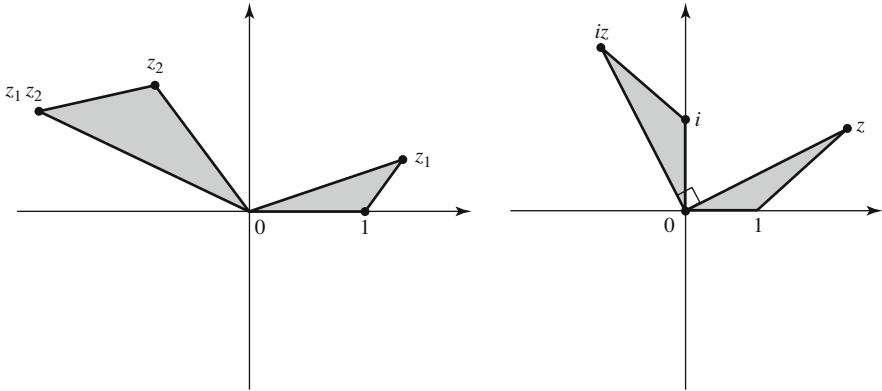

With $z = x + iy$, the following terms are commonly used:

$\operatorname{Re} z$, the *real part* of z , is x ;

$\operatorname{Im} z$, the *imaginary part* of z , is y (note that $\operatorname{Im} z$ is a real number);

\bar{z} , the *conjugate* of z , is $x - iy$.

Geometrically, \bar{z} is the mirror image of z reflected across the real axis.

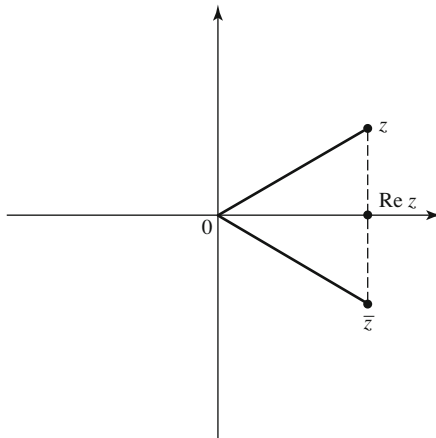

$|z|$, the *absolute value* or *modulus* of z , is equal to $\sqrt{x^2 + y^2}$; that is, it is the length of the vector z . Note also that $|z_1 - z_2|$ is the (Euclidean) distance between z_1 and z_2 . Hence we can think of $|z_2|$ as the distance between $z_1 + z_2$ and z_1 and thereby obtain a proof of the triangle inequality:

$$|z_1 + z_2| \leq |z_1| + |z_2|.$$

An algebraic proof of the inequality is outlined in Exercise 8.

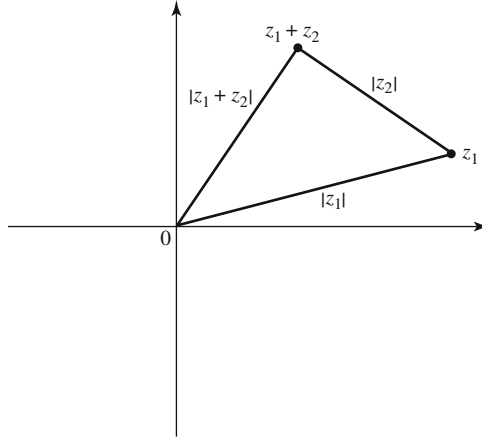

Arg z, the *argument* of z , defined for $z \neq 0$, is the angle which the vector (originating from 0) to z makes with the positive x -axis. Thus $\text{Arg } z$ is defined (modulo 2π) as that number θ for which

$$\cos \theta = \frac{\text{Re } z}{|z|}; \quad \sin \theta = \frac{\text{Im } z}{|z|}.$$

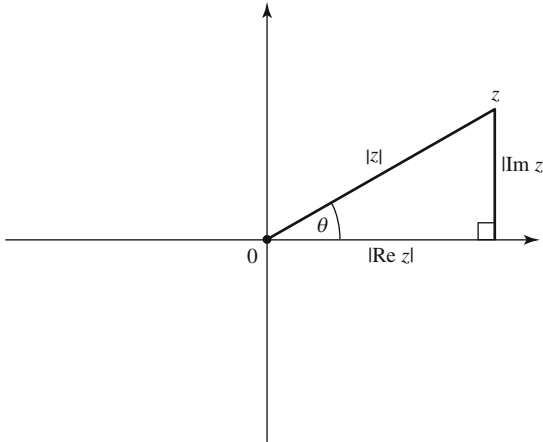

EXAMPLES

- i. The set of points given by the equation $\text{Re } z > 0$ is represented geometrically by the right half-plane.
- ii. $\{z : z = \bar{z}\}$ is the real line.
- iii. $\{z : -\theta < \text{Arg } z < \theta\}$ is an angular sector (wedge) of angle 2θ .
- iv. $\{z : |\text{Arg } z - \pi/2| < \pi/2\} = \{z : \text{Im } z > 0\}$.
- v. $\{z : |z + 1| < 1\}$ is the disc of radius 1 centered at -1 .

◇

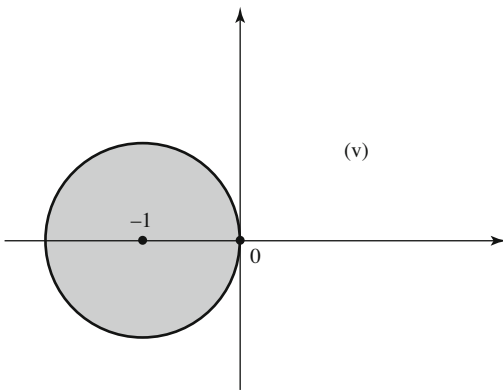
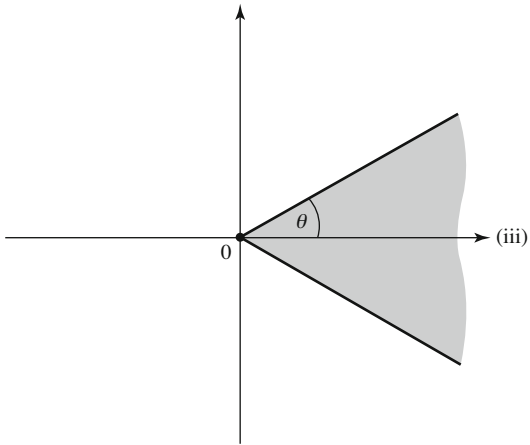
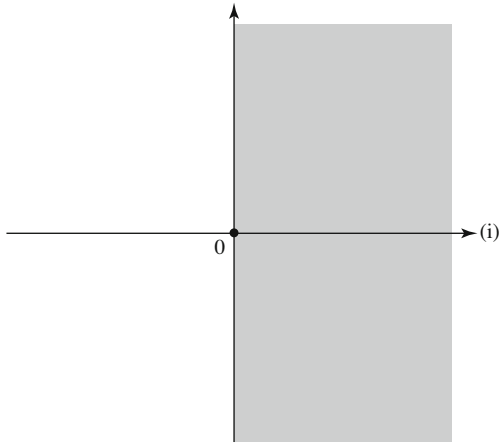

A nonzero complex number is completely determined by its modulus and argument. If $z = x + iy$ with $|z| = r$ and $\text{Arg } z = \theta$, it follows that $x = r \cos \theta$, $y = r \sin \theta$ and

$$z = r(\cos \theta + i \sin \theta).$$

We abbreviate $\cos \theta + i \sin \theta$ as $\text{cis } \theta$. In this context, r and θ are called the polar coordinates of z and $r \text{cis } \theta$ is called the polar form of the complex number z . This form is especially handy for multiplication. Let $z_1 = r_1 \text{cis } \theta_1$, $z_2 = r_2 \text{cis } \theta_2$. Then

$$z_1 z_2 = r_1 r_2 \text{cis } \theta_1 \text{cis } \theta_2 = r_1 r_2 \text{cis}(\theta_1 + \theta_2),$$

since

$$\begin{aligned} & (\cos \theta_1 + i \sin \theta_1)(\cos \theta_2 + i \sin \theta_2) \\ &= (\cos \theta_1 \cos \theta_2 - \sin \theta_1 \sin \theta_2) + i(\sin \theta_1 \cos \theta_2 + \cos \theta_1 \sin \theta_2) \\ &= \cos(\theta_1 + \theta_2) + i \sin(\theta_1 + \theta_2) \\ &= \text{cis}(\theta_1 + \theta_2). \end{aligned}$$

Thus, if z is the product of two complex numbers, $|z|$ is the product of their moduli and $\text{Arg } z$ is the sum of their arguments (modulo 2π). (This can be used to verify the geometric construction for $z_1 z_2$ given at the beginning of this section.) Similarly z_1/z_2 can be obtained by dividing the moduli and subtracting the arguments:

$$\frac{z_1}{z_2} = \frac{r_1}{r_2} \text{cis}(\theta_1 - \theta_2).$$

It follows by induction that if $z = r \text{cis } \theta$ and n is any integer,

$$z^n = r^n \text{cis } n\theta. \quad (1)$$

Identity (1) is especially handy for solving “pure” equations of the form $z^n = z_0$.

EXAMPLE

To find the cube roots of 1, we write $z^3 = 1$ in the polar form

$$r^3 \text{cis } 3\theta = 1 \text{cis } 0,$$

which is satisfied if and only if

$$r = 1, 3\theta = 0 \text{ (modulo } 2\pi\text{)}.$$

Hence the three solutions are given by

$$z_1 = \text{cis } 0, \quad z_2 = \text{cis } \frac{2\pi}{3}, \quad z_3 = \text{cis } \frac{4\pi}{3},$$

or in rectangular (x, y) coordinates

$$z_1 = 1, \quad z_2 = -\frac{1}{2} + i\frac{\sqrt{3}}{2}, \quad z_3 = -\frac{1}{2} - i\frac{\sqrt{3}}{2}.$$

The polar form of the three cube roots reveals that they are the vertices of an equilateral triangle inscribed in the unit circle. Similarly the n -th roots of 1 are located at the vertices of the regular n -gon inscribed in the unit circle with one vertex at $z = 1$. For example, the fourth roots of 1 are ± 1 and $\pm i$. \diamond

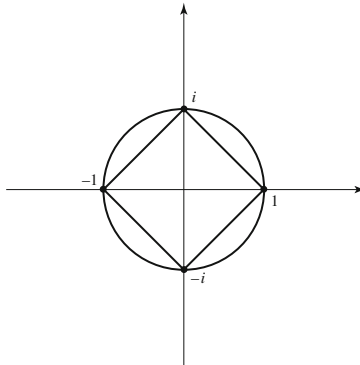

1.3 The Solution of the Cubic Equation

As we mentioned at the beginning of this chapter, complex numbers were applied to the solution of quadratic and cubic equations as far back as the 16th century. While neither of these applications was sufficient to gain a wide acceptance of complex numbers, there was a fundamental difference between the two. In the case of quadratic equations, it may have seemed interesting that solutions could always be found among the complex numbers, but this was generally viewed as nothing more than an oddity at best. After all, if a quadratic equation (with real coefficients) had no real solutions, it seemed just as reasonable to simply say that there were no solutions as to describe so-called solutions in terms of some imaginary number.

Cubic equations presented a much more tantalizing situation. For one thing, every cubic equation with real coefficients has a real solution. The fact that such a real solution could be found through the use of complex numbers showed that the complex numbers were at least useful, even if somewhat illegitimate. In fact, the solution of the cubic equation was followed by a string of other applications which demonstrated the uncanny ability of complex numbers to play a role in the solution of problems involving real numbers and functions.

Let's see how complex numbers were first applied to cubic equations. There is obviously no loss in assuming that the general cubic equation:

$$ax^3 + bx^2 + cx + d = 0$$

has leading coefficient $a = 1$. The equation can then be further reduced to the simpler form:

$$x^3 + px + q = 0 \quad (1)$$

if we change x into $x - \frac{b}{3}$. The first recorded solution for cubic equations involved a method for finding the real solution of the above “reduced” or “depressed” cubic in the form:

$$x^3 + px = q \quad (2)$$

To the modern reader, of course, equation (2) is, for all practical purposes, identical to equation (1). But in the early 16th century, mathematicians were not entirely comfortable with negative numbers either, and it was assumed that the coefficients p and q in equation (2) denoted positive real numbers. In fact, in that case, $f(x) = x^3 + px$ is a monotonically increasing function, so that equation (2) has exactly one positive real solution. To find that solution, del Ferro (1465–1526) suggested setting $x = u + v$, so that (2) could be rewritten as:

$$u^3 + v^3 + (3uv + p)(u + v) = q \quad (3)$$

The solution to (3) can be found, then, by solving the pair of equations: $3uv + p = 0$ and $u^3 + v^3 = q$. Using the first equation to express v in terms of u , and substituting into the second equation leads to:

$$u^6 - u^3q - \frac{p^3}{27} = 0$$

which is a quadratic equation for u^3 and has the solutions

$$u^3 = \frac{q \pm \sqrt{q^2 + 4p^3/27}}{2}.$$

The identical formula can be obtained for v^3 , and since $u^3 + v^3 = q$,

$$x = u + v = \sqrt[3]{\frac{q + \sqrt{q^2 + 4p^3/27}}{2}} + \sqrt[3]{\frac{q - \sqrt{q^2 + 4p^3/27}}{2}}. \quad (4)$$

or, as del Ferro would have written it to avoid the cube root of a negative number,

$$x = u + v = \sqrt[3]{\frac{\sqrt{q^2 + 4p^3/27} + q}{2}} - \sqrt[3]{\frac{\sqrt{q^2 + 4p^3/27} - q}{2}}$$

For example, if $p = 6$ and $q = 20$, we find $x = \sqrt[3]{6\sqrt{3} + 10} - \sqrt[3]{6\sqrt{3} - 10}$ or (check this!) $x = 2$.

Although (4) was originally intended to be applied with $p, q > 0$, it can obviously be applied equally well for any values of p and q . Changing q into $-q$ would simply cause the same change in x . For example, the unique real solution

of the equation $x^3 + 6x = -20$ is $x = -2$. Changing p into a negative number, however, can introduce complex values. To be precise, if $q^2 + 4p^3/27 < 0$; i.e., if $4p^3 < -27q^2$, equation (4) gives the solution as the sum of the cube roots of two complex conjugates. For example, if we apply (4) to the equation $x^3 - 6x = 4$, we obtain

$$x = \sqrt[3]{2 + 2i} + \sqrt[3]{2 - 2i} \quad (5)$$

Since we saw (in the last section) that we can calculate the three cube roots of any complex number using its polar form, and since the cube roots of a conjugate of any complex number are the conjugates of its cube roots, we realize that (5) actually does give the three real roots of $x^3 - 6x = 4$.

To Cardan, however, who published formula (4) in his *Ars Magna* (1545), the case: $4p^3 < -27q^2$ presented a dilemma. We leave it as an exercise to verify that equation (2) has three real roots if and only if $4p^3 < -27q^2$. Ironically, then, precisely in the case when all three solutions are real, if formula (4) is applicable at all, it gives the solutions in terms of cube roots of complex numbers! Moreover, Cardan was willing to try a direct approach to finding the cube roots of a complex number (as we found the square roots of any complex number in section 1), but solving the equation $(x + iy)^3 = a + bi$ by equating real and imaginary parts led to an equation no less complicated than the original cubic. Cardan, therefore, labeled this situation the “irreducible” case of the depressed cubic equation.

Fortunately, however, the idea of applying (4) even in the “irreducible” case, was never laid to rest. Bombelli’s *Algebra* (1574) included the equation $x^3 = 15x + 4$, which led to the mysterious solution

$$x = \sqrt[3]{2 + 11i} + \sqrt[3]{2 - 11i} \quad (6)$$

By a direct approach, combined with the assumption that the cube roots in (6) would involve integral real and imaginary parts, Bombelli was able to show that formula (6) did “contain” the solution $x = 4$ in the form of $(2 + i) + (2 - i)$. He did not suggest that (6) might also contain the other two real roots nor did he generalize the method. In fact, over a hundred years later, the issue was still not resolved. Thus Leibniz (1646–1716) continued to question how “a quantity could be real when imaginary or impossible numbers were used to express it”. But he too could not let the matter go. Among unpublished papers found after his death, there were several identities similar to

$$\sqrt[3]{36 + \sqrt{-2000}} + \sqrt[3]{36 - \sqrt{-2000}} = -6$$

which he found by applying (4) to: $x^3 - 48x - 72 = 0$.

So complex numbers maintained their presence, albeit as second-class citizens, in the world of numbers until the early 19th century when the spread of their geometric interpretation began the process of their acceptance as first-class citizens.

1.4 Topological Aspects of the Complex Plane

I. Sequences and Series The concept of absolute value can be used to define the notion of a limit of a sequence of complex numbers.

1.2 Definition

The sequence z_1, z_2, z_3, \dots converges to z if the sequence of real numbers $|z_n - z|$ converges to 0. That is, $z_n \rightarrow z$ if $|z_n - z| \rightarrow 0$.

Geometrically, $z_n \rightarrow z$ if each disc about z contains all but finitely many of the members of the sequence $\{z_n\}$.

Since

$$|\operatorname{Re} z|, |\operatorname{Im} z| \leq |z| \leq |\operatorname{Re} z| + |\operatorname{Im} z|,$$

$z_n \rightarrow z$ if and only if $\operatorname{Re} z_n \rightarrow \operatorname{Re} z$ and $\operatorname{Im} z_n \rightarrow \operatorname{Im} z$.

EXAMPLES

- $z^n \rightarrow 0$ if $|z| < 1$ since $|z^n - 0| = |z|^n \rightarrow 0$.
- $\frac{n}{n+i} \rightarrow 1$ since $\left| \frac{n}{n+i} - 1 \right| = \left| \frac{-i}{n+i} \right| = \frac{1}{\sqrt{n^2+1}} \rightarrow 0$. ◇

1.3 Definition

$\{z_n\}$ is called a *Cauchy sequence* if for each $\epsilon > 0$ there exists an integer N such that $n, m > N$ implies $|z_n - z_m| < \epsilon$.

1.4 Proposition

$\{z_n\}$ converges if and only if $\{z_n\}$ is a Cauchy sequence.

Proof

If $z_n \rightarrow z$, then $\operatorname{Re} z_n \rightarrow \operatorname{Re} z$, $\operatorname{Im} z_n \rightarrow \operatorname{Im} z$ and hence $\{\operatorname{Re} z_n\}$ and $\{\operatorname{Im} z_n\}$ are Cauchy sequences. But since

$$\begin{aligned} |z_n - z_m| &\leq |\operatorname{Re}(z_n - z_m)| + |\operatorname{Im}(z_n - z_m)| \\ &= |\operatorname{Re} z_n - \operatorname{Re} z_m| + |\operatorname{Im} z_n - \operatorname{Im} z_m|, \end{aligned}$$

$\{z_n\}$ is also a Cauchy sequence.

Conversely, if $\{z_n\}$ is a Cauchy sequence so are the real sequences $\{\operatorname{Re} z_n\}$ and $\{\operatorname{Im} z_n\}$. Hence both $\{\operatorname{Re} z_n\}$ and $\{\operatorname{Im} z_n\}$ converge, and thus $\{z_n\}$ converges. □

An infinite series $\sum_{k=1}^{\infty} z_k$ is said to converge if the sequence $\{s_n\}$ of partial sums, defined by $s_n = z_1 + z_2 + \dots + z_n$, converges. If so, the limit of the sequence is called

the sum of the series. The basic properties of infinite series listed below will be familiar from the theory of real series.

- i. The sum and the difference of two convergent series are convergent.
- ii. A necessary condition for $\sum_{k=1}^{\infty} z_k$ to converge is that $z_n \rightarrow 0$ as $n \rightarrow \infty$.
- iii. A sufficient condition for $\sum_{k=1}^{\infty} z_k$ to converge is that $\sum_{k=1}^{\infty} |z_k|$ converges. When $\sum_{k=1}^{\infty} |z_k|$ converges, we will say $\sum_{k=1}^{\infty} z_k$ is *absolutely convergent*.

Property (iii), which will be important in later chapters, follows from Proposition 1.4. For if $\sum_{k=1}^{\infty} |z_k|$ converges and $t_n = |z_1| + |z_2| + \cdots + |z_n|$ then $\{t_n\}$ is a Cauchy sequence. But then so is the sequence $\{s_n\}$ given by $s_n = z_1 + z_2 + \cdots + z_n$, since

$$\begin{aligned} |s_m - s_n| &= |z_{n+1} + z_{n+2} + \cdots + z_m| \\ &\leq |z_{n+1}| + |z_{n+2}| + \cdots + |z_m| = |t_m - t_n| \end{aligned}$$

by the triangle inequality. Hence $\sum_{k=1}^{\infty} z_k$ converges.

EXAMPLES

1. $\sum_{k=1}^{\infty} \frac{i^k}{k^2 + i}$ converges since

$$\left| \frac{i^k}{k^2 + i} \right| = \frac{1}{\sqrt{k^4 + 1}} \text{ and since } \sum_{k=1}^{\infty} \frac{1}{\sqrt{k^4 + 1}} \text{ converges.}$$

2. $\sum_{k=1}^{\infty} \frac{1}{k+i}$ diverges, since

$$\frac{1}{k+i} = \frac{k-i}{k^2+1}, \text{ which implies that } \sum_{k=1}^{\infty} \operatorname{Re} \left(\frac{1}{k+i} \right) \text{ diverges.} \quad \diamond$$

II. Classification of Sets in the Complex Plane We give some definitions relating to planar sets.

1.5 Definitions

$D(z_0; r)$ denotes the open disc of radius $r > 0$ centered at z_0 ; i.e., $D(z_0; r) = \{z : |z - z_0| < r\}$.

$D(z_0; r)$ is also called a *neighborhood* (or r -neighborhood) of z_0 .

$C(z_0; r)$ is the circle of radius $r > 0$ centered at z_0 .

A set S is said to be *open* if for any $z \in S$, there exists $\delta > 0$ such that $D(z; \delta) \subset S$.

For any set S , $\tilde{S} = \mathbb{C} \setminus S$ denotes the complement of S ; i.e., $\tilde{S} = \{z \in \mathbb{C} : z \notin S\}$.

A set is *closed set* if its complement is open. Equivalently, S is closed if $\{z_n\} \subset S$ and $z_n \rightarrow z$ imply $z \in S$.

∂S , the *boundary* of S , is defined as the set of points whose δ -neighborhoods have a nonempty intersection with both S and \tilde{S} , for every $\delta > 0$.

\bar{S} , the *closure* of S , is given by $\bar{S} = S \cup \partial S$.

S is *bounded* if it is contained in $D(0; M)$ for some $M > 0$.

Sets that are closed and bounded are called *compact*.

S is said to be *disconnected* if there exist two disjoint open sets A and B whose union contains S while neither A nor B alone contains S . If S is not disconnected, it is called *connected*.

$[z_1, z_2]$ denotes the line segment with endpoints z_1 and z_2 .

A *polygonal line* is a finite union of line segments of the form $[z_0, z_1] \cup [z_1, z_2] \cup [z_2, z_3] \dots \cup [z_{n-1}, z_n]$.

If any two points of S can be connected by a polygonal line contained in S , S is said to be *polygonally connected*.

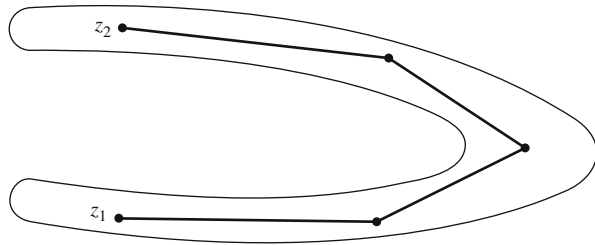

It can be shown that a polygonally connected set is connected. The converse, however, is false. For example, the set of points $z = x + iy$ with $y = x^2$ is clearly connected but is not polygonally connected since the set contains no straight line segments. In fact there are even connected sets whose points cannot be connected to one another by any curve in the set (see Exercise 23). On the other hand, for open sets, connectedness and polygonal connectedness are equivalent.

1.6 Definition

An open connected set will be called a *region*.

1.7 Proposition

A region S is polygonally connected.

Proof

Suppose $z_0 \in S$. Let A be the set of points of S which can be polygonally connected to z_0 in S and let B represent the set of points in S which cannot. Since any point z can be connected to any other point in $D(z; \delta)$, it follows that A is open. Similarly B is open. For if any point in a disc about z could be connected to z_0 , then z could be connected to z_0 . Now S is connected, $S = A \cup B$ and A is nonempty; hence we must conclude that B is empty. Finally, since every point in S can be connected to z_0 , every pair of points can be connected to each other by a polygonal line in S . \square

III Continuous Functions

1.8 Definition

A complex valued function $f(z)$ defined in a neighborhood of z_0 is *continuous at z_0* if $z_n \rightarrow z_0$ implies that $f(z_n) \rightarrow f(z_0)$. Alternatively, f is continuous at z_0 if for

each $\epsilon > 0$ there is some $\delta > 0$ such that $|z - z_0| < \delta$ implies that $|f(z) - f(z_0)| < \epsilon$. f is *continuous in a domain* D if for each sequence $\{z_n\} \subset D$ and $z \in D$ such that $z_n \rightarrow z$, we have $f(z_n) \rightarrow f(z)$.

If we split f into its real and imaginary parts

$$f(z) = f(x, y) = u(x, y) + iv(x, y),$$

where u and v are real-valued, it is clear that f is continuous if and only if u and v are continuous functions of (x, y) . Thus, for example, any polynomial

$$P(x, y) = \sum_{j=1}^m \sum_{k=1}^n a_{kj} x^k y^j$$

is continuous in the whole plane. Similarly

$$\frac{1}{z} = \frac{x}{x^2 + y^2} - i \frac{y}{x^2 + y^2}$$

is continuous in the “punctured plane” $\{z : z \neq 0\}$. It follows also that the sum, product, and quotient (with nonzero denominator) of continuous functions are continuous.

We say $f \in C^n$ if the real and imaginary parts of f both have continuous partial derivatives of the n -th order.

A sequence of functions $\{f_n\}$ *converges to f uniformly in D* if for each $\epsilon > 0$, there is an $N > 0$ such that $n > N$ implies $|f_n(z) - f(z)| < \epsilon$ for all $z \in D$. Again, by referring to the real and imaginary parts of $\{f_n\}$, it is clear that the uniform limit of continuous functions is continuous.

1.9 M-Test

Suppose f_k is continuous in D , $k = 1, 2, \dots$. If $|f_k(z)| \leq M_k$ throughout D and if $\sum_{k=1}^{\infty} M_k$ converges, then $\sum_{k=1}^{\infty} f_k(z)$ converges to a function f which is continuous in D .

Proof

The convergence of $\sum_{k=1}^{\infty} f_k(z)$ is immediate. Moreover, for each $\epsilon > 0$, we can choose N so that

$$\left| f(z) - \sum_{k=1}^n f_k(z) \right| = \left| \sum_{k=n+1}^{\infty} f_k(z) \right| \leq M_{n+1} + M_{n+2} + \dots < \epsilon$$

for $n \geq N$. Hence the convergence is uniform and f is continuous. \square

EXAMPLE

$f(z) = \sum_{k=1}^{\infty} kz^k$ is continuous in $D : |z| \leq \frac{1}{2}$ since

$$|kz^k| \leq \frac{k}{2^k} \text{ in } D \text{ and } \sum_{k=1}^{\infty} \frac{k}{2^k}$$

converges. (See Exercise 21.) \diamond

Recall that a continuous function maps compact/connected sets into compact/connected sets. None of the other properties listed above, though, are preserved under continuous mappings. For example $f(z) = \operatorname{Re} z$ maps the open set \mathbb{C} into the real line which is not open. The function $g(z) = 1/z$ maps the bounded set: $0 < |z| < 1$ onto the unbounded set: $|z| > 1$.

Most of the key results in subsequent chapters will concern properties of (a certain class of) functions defined on a region. We note that, arguing as in the proof of Proposition 1.7, we could show that any two points in a region can be connected by a polygonal line containing only horizontal and vertical line segments. For future reference we will introduce the term *polygonal path* to denote such a polygonal line.

One important result regarding real-valued functions on a region is given below.

1.10 Theorem

Suppose $u(x, y)$ has partial derivatives u_x and u_y that vanish at every point of a region D . Then u is constant in D .

Proof

Let (x_1, y_1) and (x_2, y_2) be two points of D . Then, as noted above, they can be connected by a polygonal path that is contained in D . Any two successive vertices of the path represent the end-points of a horizontal or vertical segment. Hence, by the Mean-Value Theorem for one real variable, the change in u between these vertices is given by the value of a partial derivative of u somewhere between the end-points times the difference in the non-identical coordinates of the endpoints. Since, however, u_x and u_y vanish identically in D , the change in u is 0 between each pair of successive vertices; hence $u(x_1, y_1) = u(x_2, y_2)$. \square

1.5 Stereographic Projection; The Point at Infinity

The complex numbers can also be represented by the points on the surface of a punctured sphere. Let

$$\Sigma = \left\{ (\zeta, \eta, \zeta) : \zeta^2 + \eta^2 + \left(\zeta - \frac{1}{2} \right)^2 = \frac{1}{4} \right\}; \quad (1)$$

that is, let Σ be the sphere in Euclidean (ξ, η, ζ) space with distance $\frac{1}{2}$ from $(0, 0, \frac{1}{2})$. Suppose, moreover, that the plane $\zeta = 0$ coincides with the complex plane \mathbb{C} , and that the ξ and η axes are the x and y axes, respectively. To each $(\xi, \eta, \zeta) \in \Sigma$ we associate the complex number z where the ray from $(0, 0, 1)$ through (ξ, η, ζ) intersects \mathbb{C} . This establishes a 1-1 correspondence, known as stereographic projection, between \mathbb{C} and the points of Σ other than $(0, 0, 1)$. Formulas governing this correspondence can be derived as follows. Since $(0, 0, 1)$, (ξ, η, ζ) and $(x, y, 0)$ are collinear,

$$\frac{x}{\xi} = \frac{y}{\eta} = \frac{1}{1 - \zeta}$$

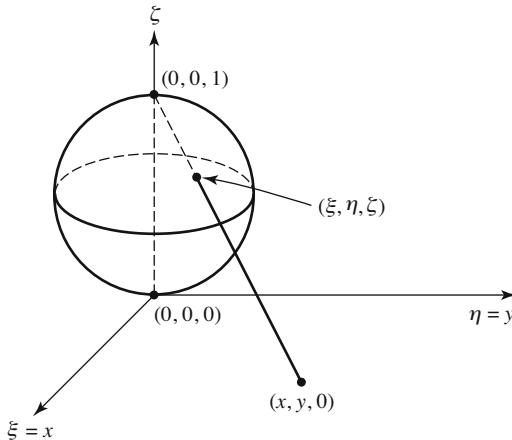

so that

$$x = \frac{\xi}{1 - \zeta}; \quad y = \frac{\eta}{1 - \zeta}. \quad (2)$$

We leave it as an exercise to show that the equations (1) and (2) can be solved for ξ, η, ζ in terms of x, y as

$$\xi = \frac{x}{x^2 + y^2 + 1}; \quad \eta = \frac{y}{x^2 + y^2 + 1}; \quad \zeta = \frac{x^2 + y^2}{x^2 + y^2 + 1}. \quad (3)$$

Now suppose that $\{\sigma_k\} = \{(\xi_k, \eta_k, \zeta_k)\}$ is a sequence of points of Σ which converges to $(0, 0, 1)$ and let $\{z_k\}$ be the corresponding sequence in \mathbb{C} . By (2),

$$x^2 + y^2 = \frac{\xi^2 + \eta^2}{(1 - \zeta)^2} = \frac{\zeta}{1 - \zeta},$$

so that as $\sigma_k \rightarrow (0, 0, 1)$, $|z_k| \rightarrow \infty$. Conversely, it follows from (3) that if $|z_k| \rightarrow \infty$, $\sigma_k \rightarrow (0, 0, 1)$. Loosely speaking, this suggests that the point $(0, 0, 1)$ on Σ corresponds to ∞ in the complex plane. We can make this more precise by formally adjoining to \mathbb{C} a “point at infinity” and defining its neighborhoods as the sets in \mathbb{C} corresponding to the spherical neighborhoods of $(0, 0, 1)$. (See Exercise 24.)

While we will not examine the resulting “extended plane” in greater detail, we will adopt the following convention.

1.11 Definition

We say $\{z_k\} \rightarrow \infty$ if $|z_k| \rightarrow \infty$; i.e., $|z_k| \rightarrow \infty$ if for any $M > 0$, there exists an integer N such that $k > N$ implies $|z_k| > M$. Similarly, we say $f(z) \rightarrow \infty$ if $|f(z)| \rightarrow \infty$.

For future reference, we note the connection between circles on Σ and circles in \mathbb{C} . By a circle on Σ , we mean the intersection of Σ with a plane of the form $A\xi + B\eta + C\zeta = D$. According to (3), if S is such a circle and T is the corresponding set in \mathbb{C} ,

$$(C - D)(x^2 + y^2) + Ax + By = D \quad (4)$$

for $(x, y) \in T$. Note that if $C \neq D$, (4) is the equation of a circle. If $C = D$, (4) represents a line. Since $C = D$ if and only if S intersects $(0, 0, 1)$, we have the following proposition.

1.12 Proposition

Let S be a circle on Σ and let T be its projection on \mathbb{C} . Then

- a. if S contains $(0, 0, 1)$, T is a line;
- b. if S doesn't contain $(0, 0, 1)$, T is a circle.

The converse of Proposition 1.12 is also valid. We leave its proof as an exercise. (See Exercise 25.)

Exercises

1. Express in the form $a + bi$:
 - a. $\frac{1}{6 + 2i}$
 - b. $\frac{(2 + i)(3 + 2i)}{1 - i}$
 - c. $\left(-\frac{1}{2} + i\frac{\sqrt{3}}{2}\right)^4$
 - d. $i^2, i^3, i^4, i^5, \dots$
2. Find (in rectangular form) the two values of $\sqrt{-8 + 6i}$.
3. Solve the equation $z^2 + \sqrt{32}iz - 6i = 0$.
4. Prove the following identities:
 - a. $\overline{z_1 + z_2} = \overline{z_1} + \overline{z_2}$.
 - b. $\overline{z_1 z_2} = \overline{z_1} \cdot \overline{z_2}$.
 - c. $\overline{P(\bar{z})} = P(z)$, for any polynomial P with *real* coefficients.
 - d. $\overline{\bar{z}} = z$.
5. Suppose P is a polynomial with real coefficients. Show that $P(z) = 0$ if and only if $P(\bar{z}) = 0$ [i.e., zeroes of “real” polynomials come in conjugate pairs].
6. Verify that $|z^2| = |z|^2$ using rectangular coordinates and then using polar coordinates.

7. Show

- $|z^n| = |z|^n$.
- $|z|^2 = z\bar{z}$.
- $|\operatorname{Re} z|, |\operatorname{Im} z| \leq |z| \leq |\operatorname{Re} z| + |\operatorname{Im} z|$.
(When is equality possible?)

8. a. Fill in the details of the following proof of the triangle inequality:

$$\begin{aligned} |z_1 + z_2|^2 &= (z_1 + z_2)(\bar{z}_1 + \bar{z}_2) \\ &= |z_1|^2 + |z_2|^2 + z_1\bar{z}_2 + \bar{z}_1z_2 \\ &= |z_1|^2 + |z_2|^2 + 2\operatorname{Re}(z_1\bar{z}_2) \\ &\leq |z_1|^2 + |z_2|^2 + 2|z_1||z_2| \\ &= (|z_1| + |z_2|)^2. \end{aligned}$$

- When can equality occur?
- Show: $|z_1 - z_2| \geq |z_1| - |z_2|$.

9.* It is an interesting fact that a product of two sums of squares is itself a sum of squares. For example,

$$(1^2 + 2^2)(3^2 + 4^2) = 125 = 5^2 + 10^2 = 2^2 + 11^2.$$

- Prove the result using complex algebra. That is, show that for any two pairs of integers $\{a, b\}$ and $\{c, d\}$, we can find integers u, v with

$$(a^2 + b^2)(c^2 + d^2) = u^2 + v^2$$

- Show that, if a, b, c, d are all nonzero and *at least one* of the sets $\{a^2, b^2\}$ and $\{c^2, d^2\}$ consists of distinct positive integers, then we can find u^2, v^2 as above with u^2 and v^2 both positive.
- Show that, if a, b, c, d are all nonzero and *both* of the sets $\{a^2, b^2\}$ and $\{c^2, d^2\}$ consist of distinct positive integers, then there are two *different* sets $\{u^2, v^2\}$ and $\{s^2, t^2\}$ with

$$(a^2 + b^2)(c^2 + d^2) = u^2 + v^2 = s^2 + t^2.$$

- Give a geometric interpretation and proof of the results in b) and c), above.

10.* Prove: $|z_1 + z_2|^2 + |z_1 - z_2|^2 = 2(|z_1|^2 + |z_2|^2)$ and interpret the result geometrically.

- Let $z = x + iy$. Explain the connection between $\operatorname{Arg} z$ and $\tan^{-1}(y/x)$. (Warning: they are not identical.)
- Solve the following equations in polar form and locate the roots in the complex plane:
 - $z^6 = 1$.
 - $z^4 = -1$.
 - $z^4 = -1 + \sqrt{3}i$.
- Show that the n -th roots of 1 (aside from 1) satisfy the “cyclotomic” equation $z^{n-1} + z^{n-2} + \dots + z + 1 = 0$. [Hint: Use the identity $z^n - 1 = (z - 1)(z^{n-1} + z^{n-2} + \dots + 1)$.]
- Suppose we consider the $n - 1$ diagonals of a regular n -gon inscribed in a unit circle obtained by connecting one vertex with all the others. Show that the product of their lengths is n . [Hint: Let the vertices all be connected to 1 and apply the previous exercise.]

15. Describe the sets whose points satisfy the following relations. Which of the sets are regions?

a. $|z - i| \leq 1$.

b. $\left| \frac{z-1}{z+1} \right| = 1$.

c. $|z - 2| > |z - 3|$.

d. $|z| < 1$ and $\text{Im } z > 0$.

e. $\frac{1}{z} = \bar{z}$.

f. $|z|^2 = \text{Im } z$.

g. $|z^2 - 1| < 1$. [Hint: Use polar coordinates.]

16.* Identify the set of points which satisfy

a. $|z| = \text{Re } z + 1$

b. $|z - 1| + |z + 1| = 4$

c. $z^{n-1} = \bar{z}$

17. Let $\text{Arg } w$ denote that value of the argument between $-\pi$ and π (inclusive). Show that

$$\text{Arg} \left(\frac{z-1}{z+1} \right) = \begin{cases} \pi/2 & \text{if } \text{Im } z > 0 \\ -\pi/2 & \text{if } \text{Im } z < 0 \end{cases}$$

where z is a point on the unit circle $|z| = 1$.

18.* Find the three roots of $x^3 - 6x = 4$ by finding the three real-valued possibilities for $\sqrt[3]{2+2i} + \sqrt[3]{2-2i}$. (Note: You can find the three cube roots of $2+2i$, or you can simplify the problem by first applying the identity: $a+b = (a^3+b^3)/(a^2-ab+b^2)$).

19.* Prove that $x^3 + px = q$ has three real roots if and only if $4p^3 < -27q^2$. (Hint: Find the local minimum and local maximum values of $x^3 + px - q$).

20.* a. Let $P(z) = 1 + 2z + 3z^2 + \dots + nz^{n-1}$. By considering $(1-z)P(z)$, show that all the zeroes of $P(z)$ are inside the unit disc.

b. Show that the same conclusion applies to any polynomial of the form: $a_0 + a_1z + a_2z^2 + \dots + a_nz^n$, with all a_i real and $0 \leq a_0 \leq a_1 \leq \dots \leq a_n$

21. Show that

a. $f(z) = \sum_{k=0}^{\infty} kz^k$ is continuous in $|z| < 1$.

b. $g(z) = \sum_{k=1}^{\infty} 1/(k^2 + z)$ is continuous in the right half-plane $\text{Re } z > 0$.

22. Prove that a polygonally connected set is connected.

23. Let

$$S = \left\{ x + iy : x = 0 \text{ or } x > 0, y = \sin \frac{1}{x} \right\}.$$

Show that S is connected, even though there are points in S that cannot be connected by any curve in S .

24. Let $S = \{(\zeta, \eta, \zeta) \in \Sigma : \zeta \geq \zeta_0\}$, where $0 < \zeta_0 < 1$ and let T be the corresponding set in \mathbb{C} . Show that T is the exterior of a circle centered at 0.

25. Suppose $T \subset \mathbb{C}$. Show that the corresponding set $S \subset \Sigma$ is

a. a circle if T is a circle.

b. a circle minus $(0, 0, 1)$ if T is a line.

26. Let P be a nonconstant polynomial in z . Show that $P(z) \rightarrow \infty$ as $z \rightarrow \infty$.

27. Suppose that z is the stereographic projection of (ξ, η, ζ) and $1/z$ is the projection of (ξ', η', ζ') .

a. Show that $(\xi', \eta', \zeta') = (\xi, -\eta, 1 - \zeta)$.

b. Show that the function $1/z, z \in \mathbb{C}$, is represented on Σ by a 180° rotation about the diameter with endpoints $(-\frac{1}{2}, 0, \frac{1}{2})$ and $(\frac{1}{2}, 0, \frac{1}{2})$.

28. Use exercise (27) to show that $f(z) = 1/z$ maps circles and lines in \mathbb{C} onto other circles and lines.

Chapter 2

Functions of the Complex Variable z

Introduction

We wish to examine the notion of a “function of z ” where z is a complex variable. To be sure, a complex variable can be viewed as nothing but a pair of real variables so that in one sense a function of z is nothing but a function of two real variables. This was the point of view we took in the last section in discussing continuous functions. But somehow this point of view is too general. There are some functions which are “direct” functions of $z = x + iy$ and not simply functions of the separate pieces x and y .

Consider, for example, the function $x^2 - y^2 + 2ixy$. This is a direct function of $x + iy$ since $x^2 - y^2 + 2ixy = (x + iy)^2$; it is the function *squaring*. On the other hand, the only slightly different-looking function $x^2 + y^2 - 2ixy$ is not expressible as a polynomial in $x + iy$. Thus we are led to distinguish a special class of functions, those given by *direct* or *explicit* or *analytic* expressions in $x + iy$. When we finally do evolve a rigorous definition, these functions will be called the *analytic* functions. For now we restrict our attention to polynomials.

2.1 Analytic Polynomials

2.1 Definition

A polynomial $P(x, y)$ will be called an *analytic polynomial* if there exist (complex) constants α_k such that

$$P(x, y) = \alpha_0 + \alpha_1(x + iy) + \alpha_2(x + iy)^2 + \cdots + \alpha_N(x + iy)^N.$$

We will then say that P is a *polynomial in z* and write it as

$$P(z) = \alpha_0 + \alpha_1z + \alpha_2z^2 + \cdots + \alpha_Nz^N.$$

Indeed, $x^2 - y^2 + 2ixy$ is analytic. On the other hand, as we mentioned above, $x^2 + y^2 - 2ixy$ is *not* analytic, and we now prove this assertion. So suppose

$$x^2 + y^2 - 2ixy \equiv \sum_{k=0}^N a_k (x + iy)^k.$$

Setting $y = 0$, we obtain

$$x^2 \equiv \sum_{k=0}^N a_k x^k$$

or

$$a_0 + a_1x + (a_2 - 1)x^2 + \cdots + a_Nx^N \equiv 0.$$

Setting $x = 0$ gives $a_0 = 0$; dividing out by x and again setting $x = 0$ shows $a_1 = 0$, etc. We conclude that

$$\begin{aligned} a_1 &= a_3 = a_4 = \cdots = a_N = 0 \\ a_2 &= 1, \end{aligned}$$

and so our assumption that

$$x^2 + y^2 - 2ixy \equiv \sum_{k=0}^N a_k (x + iy)^k$$

has led us to

$$x^2 + y^2 - 2ixy \equiv (x + iy)^2 = x^2 - y^2 + 2ixy,$$

which is simply false!

A bit of experimentation, using the method described above (setting $y = 0$ and “comparing coefficients”) will show how rare the analytic polynomials are. A randomly chosen polynomial, $P(x, y)$, will hardly ever be analytic.

EXAMPLE

$x^2 + iv(x, y)$ is not analytic for any choice of the real polynomial $v(x, y)$. For a polynomial in z can have a real part of degree 2 in x only if it is of the form $az^2 + bz + c$ with $a \neq 0$. In that case, however, the real part must contain a y^2 term as well. \diamond

Another Way of Recognizing Analytic Polynomials We have seen, in our method of comparing coefficients, a perfectly adequate way of determining whether a given polynomial is or is not analytic. This method, we point out, can be condensed to the statement: $P(x, y)$ is analytic if and only if $P(x, y) = P(x + iy, 0)$. Looking ahead to

the time we will try to extend the notion of “analytic” beyond the class of polynomials, however, we see that we can expect trouble! What is so simple for polynomials is totally intractable for more general functions. We can evaluate $P(x + iy, 0)$ by simple arithmetic operations, but what does it mean to speak of $f(x + iy, 0)$? For example, if $f(x, y) = \cos x + i \sin y$, we observe that $f(x, 0) = \cos x$. But what shall we mean by $\cos(x + iy)$? What is needed is another means of recognizing the analytic polynomials, and for this we retreat to a familiar, real-variable situation. Suppose that we ask of apolynomial $P(x, y)$ whether it is a function of the single variable $x + 2y$. Again the answer can be given in the spirit of our previous one, namely: $P(x, y)$ is a function of $x + 2y$ if and only if $P(x, y) = P(x + 2y, 0)$. But it can also be given in terms of *partial derivatives*! A function of $x + 2y$ undergoes the same change when x changes by ϵ as when y changes $\epsilon/2$ and this means exactly that its partial derivative with the respect to y is twice its partial derivative with respect to x . That is, $P(x, y)$ is a function of $x + 2y$ if and only if $P_y = 2P_x$.

Of course, the “2” can be replaced by any real number, and we obtain the more general statement: $P(x, y)$ is a function of $x + \lambda y$ if and only if $P_y = \lambda P_x$.

Indeed for polynomials, we can even ignore the limitation that λ be real, which yields the following proposition.

2.2 Definition

Let $f(x, y) = u(x, y) + iv(x, y)$ where u and v are real-valued functions. The partial derivatives f_x and f_y are defined by $u_x + iv_x$ and $u_y + iv_y$ respectively, provided the latter exist.

2.3 Proposition

A polynomial $P(x, y)$ is analytic if and only if $P_y = iP_x$.

Proof

The necessity of the condition can be proven in a straightforward manner. We leave the details as an exercise. To show that it is also sufficient, note that if

$$P_y = iP_x,$$

the condition must be met separately by the terms of any fixed degree. Suppose then that P has n -th degree terms of the form

$$Q(x, y) = C_0x^n + C_1x^{n-1}y + C_2x^{n-2}y^2 + \cdots + C_ny^n.$$

Since

$$\begin{aligned} Q_y &= iQ_x, \\ C_1x^{n-1} + 2C_2x^{n-2}y + \cdots + nC_ny^{n-1} \\ &= i[nC_0x^{n-1} + (n-1)C_1x^{n-2}y + \cdots + C_{n-1}y^{n-1}]. \end{aligned}$$

Comparing coefficients,

$$C_1 = inC_0 = i \binom{n}{1} C_0$$

$$C_2 = \frac{i(n-1)}{2} C_1 = i^2 \frac{n(n-1)}{2} C_0 = i^2 \binom{n}{2} C_0,$$

and in general

$$C_k = i^k \binom{n}{k} C_0$$

so that

$$Q(x, y) = \sum_{k=0}^n C_k x^{n-k} y^k = C_0 \sum_{k=0}^n \binom{n}{k} x^{n-k} (iy)^k = C_0 (x + iy)^n.$$

Thus P is analytic. □

The condition $f_y = if_x$ is sometimes given in terms of the real and imaginary parts of f . That is, if $f = u + iv$, then

$$f_x = u_x + iv_x$$

$$f_y = u_y + iv_y$$

and the equation $f_y = if_x$ is equivalent to the twin equations

$$u_x = v_y; \quad u_y = -v_x. \tag{1}$$

These are usually called the *Cauchy-Riemann equations*.

EXAMPLES

1. A non-constant analytic polynomial cannot be real-valued, for then both P_x and P_y would be real and the Cauchy-Riemann equations would not be satisfied.
2. Using the Cauchy-Riemann equations, one can verify that $x^2 - y^2 + 2ixy$ is analytic while $x^2 + y^2 - 2ixy$ is not. ◇

Finally, we note that polynomials in z have another property which distinguishes them as functions of z : they can be differentiated directly with respect to z . We will make this more precise below.

2.4 Definition

A complex-valued function f , defined in a neighborhood of z , is said to be *differentiable* at z if

$$\lim_{h \rightarrow 0} \frac{f(z+h) - f(z)}{h}$$

exists. In that case, the limit is denoted $f'(z)$.

It is important to note that in Definition 2.4, h is not necessarily real. Hence the limit must exist irrespective of the manner in which h approaches 0 in the complex plane. For example, $f(z) = \bar{z}$ is not differentiable at any point z since

$$\frac{f(z+h) - f(z)}{h} = \frac{\bar{z+h} - \bar{z}}{h} = \frac{\bar{h}}{h}$$

which equals $+1$ if h is real and -1 if h is purely imaginary.

2.5 Proposition

If f and g are both differentiable at z , then so are

$$h_1 = f + g$$

$$h_2 = fg$$

and, if $g(z) \neq 0$,

$$h_3 = \frac{f}{g}.$$

In the respective cases,

$$h'_1(z) = f'(z) + g'(z)$$

$$h'_2(z) = f'(z)g(z) + f(z)g'(z)$$

$$h'_3(z) = [f'(z)g(z) - f(z)g'(z)]/g^2(z).$$

Proof

Exercise 6. □

2.6 Proposition

If $P(z) = a_0 + a_1z + \cdots + a_Nz^N$, then P is differentiable at all points z and $P'(z) = a_1 + 2a_2z + \cdots + Na_Nz^{N-1}$.

Proof

See Exercise 7. □

2.2 Power Series

We now consider a wider class of direct functions of z —those given by infinite polynomials or “power series” in z .

2.7 Definition

A power series in z is an infinite series of the form $\sum_{k=0}^{\infty} C_k z^k$.

To study the convergence of a power series, we recall the notion of the $\overline{\lim}$ of a positive real-valued sequence. That is,

$$\overline{\lim}_{n \rightarrow \infty} a_n = \lim_{n \rightarrow \infty} \left(\sup_{k \geq n} a_k \right).$$

Since $\sup_{k \geq n} a_k$ is a non-increasing function of n , the limit always exists or equals $+\infty$. The properties of the $\overline{\lim}$ which will be of interest to us are the following.

If $\overline{\lim}_{n \rightarrow \infty} a_n = L$,

- i. for each N and for each $\epsilon > 0$, there exists some $k > N$ such that $a_k \geq L - \epsilon$;
- ii. for each $\epsilon > 0$, there is some N such that $a_k \leq L + \epsilon$ for all $k > N$.
- iii. $\overline{\lim} c a_n = cL$ for any nonnegative constant c .

2.8 Theorem

Suppose $\overline{\lim} |C_k|^{1/k} = L$.

1. If $L = 0$, $\sum C_k z^k$ converges for all z .
2. If $L = \infty$, $\sum C_k z^k$ converges for $z = 0$ only.
3. If $0 < L < \infty$, set $R = 1/L$. Then $\sum C_k z^k$ converges for $|z| < R$ and diverges for $|z| > R$. (R is called the radius of convergence of the power series.)

Proof

1. $L = 0$.

Since $\overline{\lim} |C_k|^{1/k} = 0$, $\overline{\lim} |C_k|^{1/k} |z| = 0$ for all z . Thus, for each z , there is some N such that $k > N$ implies

$$|C_k z^k| \leq \frac{1}{2^k},$$

so that $\sum |C_k z^k|$ converges; therefore, by the Absolute Convergence Test, $\sum C_k z^k$ converges.

2. $L = \infty$.

For any $z \neq 0$,

$$|C_k|^{1/k} \geq \frac{1}{|z|}$$

for infinitely many values of k . Hence $|C_k z^k| \geq 1$, the terms of the series do not approach zero, and the series diverges. (The fact that the series converges for $z = 0$ is obvious.)

3. $0 < L < \infty$, $R = 1/L$.

Assume first that $|z| < R$ and set $|z| = R(1 - 2\delta)$. Then since $\overline{\lim} |C_k|^{1/k} |z| = (1 - 2\delta)$, $|C_k|^{1/k} |z| < 1 - \delta$ for sufficiently large k and $\sum C_k z^k$ is absolutely convergent. On the other hand, if $|z| > R$, $\overline{\lim} |C_k|^{1/k} |z| > 1$, so that for infinitely many values of k , $C_k z^k$ has absolute value greater than 1 and $\sum C_k z^k$ diverges. \square

Note that if $\sum_{k=0}^{\infty} C_k z^k$ has radius of convergence R , the series converges uniformly in any smaller disc: $|z| \leq R - \delta$. For then

$$\sum_{k=0}^{\infty} |C_k z^k| \leq \sum_{k=0}^{\infty} |C_k| (R - \delta)^k,$$

which also converges. Hence a power series is continuous throughout its domain of convergence. (See Theorem 1.9.)

All three cases above can be combined by noting that a power series always converges inside a disc of radius

$$R = 1/\overline{\lim} |C_k|^{1/k}.$$

Here $R = 0$ means that the series converges at $z = 0$ only and $R = \infty$ means that the series converges for all z . In the cases where $0 < R < \infty$, while the theorem assures us that the series diverges for $|z| > R$, it says nothing about the behavior of the power series on the circle of convergence $|z| = R$. As the following examples demonstrate, the series may converge for all or some or none of the points on the circle of convergence.

EXAMPLES

1. Since $n^{1/n} \rightarrow 1$, $\sum_{n=1}^{\infty} n z^n$ converges for $|z| < 1$ and diverges for $|z| > 1$. The series also diverges for $|z| = 1$ for then $|n z^n| = n \rightarrow \infty$. (See Exercise 8.)
2. $\sum_{n=1}^{\infty} (z^n/n^2)$ also has radius of convergence equal to 1. In this case, however, the series converges for all points z on the unit circle since

$$\left| \frac{z^n}{n^2} \right| = \frac{1}{n^2} \quad \text{for } |z| = 1.$$

3. $\sum_{n=1}^{\infty} (z^n/n)$ has radius of convergence equal to 1. In this case, the series converges at all points of the unit circle except $z = 1$. (See Exercise 12.)
4. $\sum_{n=0}^{\infty} (z^n/n!)$ converges for all z since

$$\frac{1}{(n!)^{1/n}} \rightarrow 0.$$

(See Exercise 13.)

5. $\sum_{n=0}^{\infty} [1 + (-1)^n]^n z^n$ has radius of convergence $\frac{1}{2}$ since $\overline{\lim} [1 + (-1)^n] = \lim 2 = 2$.

6. $\sum_{n=0}^{\infty} z^{n^2} = 1 + z + z^4 + z^9 + z^{16} + \dots$ has radius of convergence 1. In this case $\overline{\lim}|C_n|^{1/n} = \lim 1 = 1$.
7. Any series of the form $\sum C_n z^n$ with $C_n = \pm 1$ for all n has radius of convergence equal to 1. \diamond

It is easily seen that the sum of two power series is convergent wherever both of the original two power series are convergent. In fact, it follows directly from the definition of infinite series that

$$\sum_{n=0}^{\infty} (a_n + b_n)z^n = \sum_{n=0}^{\infty} a_n z^n + \sum_{n=0}^{\infty} b_n z^n.$$

Similarly if $\sum_{n=0}^{\infty} a_n z^n = A$ and $\sum_{n=0}^{\infty} b_n z^n = B$, the Cauchy product $\sum_{n=0}^{\infty} c_n z^n$ defined by $c_n = \sum_{k=0}^n a_k b_{n-k}$ converges for appropriate values of z to the product AB . The proof is the same as that for “real” power series and is outlined in Exercises 17 and 18.

2.3 Differentiability and Uniqueness of Power Series

We now show that power series, like polynomials, are differentiable functions of z . Suppose then that $\sum C_n z^n$ converges in some disc $D(0; R)$, $R > 0$. Then the series $\sum nC_n z^{n-1}$ obtained by differentiating $\sum C_n z^n$ term by term is convergent in $D(0; R)$, since

$$\overline{\lim}|nC_n|^{1/(n-1)} = \overline{\lim}(|nC_n|^{1/n})^{n/(n-1)} = \overline{\lim}|C_n|^{1/n}.$$

2.9 Theorem

Suppose $f(z) = \sum_{n=0}^{\infty} C_n z^n$ converges for $|z| < R$. Then $f'(z)$ exists and equals $\sum_{n=0}^{\infty} nC_n z^{n-1}$ throughout $|z| < R$.

Proof

We will prove the theorem in two stages. First, we will assume that $R = \infty$, then we will consider the more general situation. Of course, the second case contains the first, so the eager reader may skip the first proof. We include it since it contains the key ideas with less cumbersome details.

Case (1): Assume $\sum_{n=0}^{\infty} C_n z^n$ converges for all z . Then

$$\frac{f(z+h) - f(z)}{h} = \sum_{n=0}^{\infty} C_n \frac{[(z+h)^n - z^n]}{h}$$

and

$$\frac{f(z+h) - f(z)}{h} - \sum_{n=0}^{\infty} nC_n z^{n-1} = \sum_{n=2}^{\infty} C_n b_n$$

where

$$\begin{aligned} b_n &= \frac{(z+h)^n - z^n}{h} - nz^{n-1} \\ &= \sum_{k=2}^n \binom{n}{k} h^{k-1} z^{n-k} \leq |h| \sum_{k=0}^n \binom{n}{k} |z|^{n-k} = |h|(|z|+1)^n \end{aligned}$$

for $|h| \leq 1$. Hence, for $|h| \leq 1$,

$$\left| \frac{f(z+h) - f(z)}{h} - \sum_{n=0}^{\infty} nC_n z^{n-1} \right| \leq |h| \sum_{n=0}^{\infty} |C_n|(|z|+1)^n \leq A|h|$$

since $\sum_{n=0}^{\infty} |C_n|z^n$ converges for all z . Letting $h \rightarrow 0$, we conclude that

$$f'(z) = \sum nC_n z^{n-1}.$$

Case (2): $0 < R < \infty$.

Let $|z| = R - 2\delta$, $\delta > 0$, and assume $|h| < \delta$. Then $|z+h| < R$ and, as in the previous case, we can write

$$\frac{f(z+h) - f(z)}{h} - \sum_{n=0}^{\infty} nC_n z^{n-1} = \sum_{n=2}^{\infty} C_n b_n,$$

where

$$b_n = \sum_{k=2}^n \binom{n}{k} h^{k-1} z^{n-k}.$$

If $z = 0$, $b_n = h^{n-1}$ and the proof follows easily. Otherwise, to obtain a useful estimate for b_n we must be a little more careful. Note then that

$$\binom{n}{k} = \frac{n(n-1)\cdots(n-k+1)}{k!} \leq n^2 \binom{n}{k-2} \text{ for } k \geq 2.$$

Hence, for $z \neq 0$,

$$\begin{aligned} |b_n| &\leq \frac{n^2|h|}{|z|^2} \sum_{k=2}^n \binom{n}{k-2} |h|^{k-2} |z|^{n-(k-2)} \\ &\leq \frac{n^2|h|}{|z|^2} \sum_{j=0}^n \binom{n}{j} |h|^j |z|^{n-j} \\ &= \frac{n^2|h|}{|z|^2} (|z|+|h|)^n \\ &\leq \frac{n^2|h|}{|z|^2} (R-\delta)^n \end{aligned}$$

and

$$\left| \frac{f(z+h) - f(z)}{h} - \sum_{n=0}^{\infty} n C_n z^{n-1} \right| \leq \frac{|h|}{|z|^2} \sum_{n=0}^{\infty} n^2 |C_n| (R - \delta)^n \leq A|h|,$$

since $z \neq 0$ is fixed and since $\sum_{n=0}^{\infty} n^2 |C_n| |z|^n$ also converges for $|z| < R$. Again, letting $h \rightarrow 0$, we conclude that $f'(z) = \sum_{n=0}^{\infty} n C_n z^{n-1}$. \square

EXAMPLE

$f(z) = \sum_{n=0}^{\infty} (z^n/n!)$ is convergent for all z and, according to Theorem 2.9,

$$f'(z) = \sum_{n=0}^{\infty} \frac{nz^{n-1}}{n!} = \sum_{n=0}^{\infty} \frac{z^n}{n!} = f(z).$$

\diamond

2.10 Corollary

Power series are infinitely differentiable within their domain of convergence.

Proof

Applying the above results to $f'(z) = \sum_{n=0}^{\infty} n C_n z^{n-1}$ which has the same radius of convergence as f , we see that f is twice differentiable. By induction, $f^{(n)}$ is differentiable for all n . \square

2.11 Corollary

If $f(z) = \sum_{n=0}^{\infty} C_n z^n$ has a nonzero radius of convergence,

$$C_n = \frac{f^{(n)}(0)}{n!} \text{ for all } n.$$

Proof

By definition $f(0) = C_0$. Differentiating the power series term-by-term gives

$$f'(z) = C_1 + 2C_2z + 3C_3z^2 + \cdots$$

so that

$$f'(0) = C_1.$$

Similarly

$$f^{(n)}(z) = n!C_n + (n+1)!C_{n+1}z + \frac{(n+2)!}{2!}C_{n+2}z^2 + \cdots,$$

and the result follows by setting $z = 0$. \square

According to Corollary 2.11, if a power series is equal to zero throughout a neighborhood of the origin, it must be identically zero. For then all its derivatives at the origin—and hence all the coefficients of the power series—would equal 0. By the same reasoning, if a power series were equal to zero throughout an interval containing the origin, it would be identically zero. An even stronger result is proven below.

2.12 Uniqueness Theorem for Power Series

Suppose $\sum_{n=0}^{\infty} C_n z^n$ is zero at all points of a nonzero sequence $\{z_k\}$ which converges to zero. Then the power series is identically zero.

[Note: If we set $f(z) = \sum C_n z^n$, it follows from the continuity of power series that $f(0) = 0$. We can show by a similar argument that $f'(0) = 0$; however, a slightly different argument is needed to show that the higher coefficients are also 0.]

Proof

Let

$$f(z) = C_0 + C_1 z + C_2 z^2 + \dots$$

By the continuity of f at the origin

$$C_0 = f(0) = \lim_{z \rightarrow 0} f(z) = \lim_{k \rightarrow \infty} f(z_k) = 0.$$

But then

$$g(z) = \frac{f(z)}{z} = C_1 + C_2 z + C_3 z^2 + \dots$$

is also continuous at the origin and

$$C_1 = g(0) = \lim_{z \rightarrow 0} \frac{f(z)}{z} = \lim_{k \rightarrow \infty} \frac{f(z_k)}{z_k} = 0.$$

Similarly, if $C_j = 0$ for $0 \leq j < n$, then

$$C_n = \lim_{z \rightarrow 0} \frac{f(z)}{z^n} = \lim_{k \rightarrow \infty} \frac{f(z_k)}{z_k^n} = 0,$$

so that the power series is identically zero. □

2.13 Corollary

If a power series equals zero at all the points of a set with an accumulation point at the origin, the power series is identically zero.

Proof

Exercise 18. □

The Uniqueness Theorem derives its name from the following corollary.

2.14 Corollary

If $\sum a_n z^n$ and $\sum b_n z^n$ converge and agree on a set of points with an accumulation point at the origin, then $a_n = b_n$ for all n .

Proof

Apply 2.13 to the difference:

$$\sum (a_n - b_n) z^n.$$

□

Power Series Expansion about $z = \alpha$ All of the previous results on power series are easily adapted to power series of the form

$$\sum C_n (z - \alpha)^n.$$

By the simple substitution $w = z - \alpha$, we see, for example, that series of the above form converge in a disc of radius R about $z = \alpha$ and are differentiable throughout $|z - \alpha| < R$ where $R = 1/\overline{\lim} |C_n|^{1/n}$. (See Exercises 22 and 23.)

Exercises

- Complete the proof of Proposition 2.3 by showing that for an analytic polynomial P , $P_y = iP_x$. [Hint: Prove it first for the monomials.]
- * a. Suppose $f(z)$ is real-valued and differentiable for all real z . Show that $f'(z)$ is also real-valued for real z .
b. Suppose $f(z)$ is real-valued and differentiable for all imaginary points z . Show that $f'(z)$ is imaginary for all imaginary points z .
- By comparing coefficients or by use of the Cauchy-Riemann equations, determine which of the following polynomials are analytic.
 - $P(x + iy) = x^3 - 3xy^2 - x + i(3x^2y - y^3 - y)$.
 - $P(x + iy) = x^2 + iy^2$.
 - $P(x + iy) = 2xy + i(y^2 - x^2)$.
- Show that no nonconstant analytic polynomial can take imaginary values only.
- Find the derivative $P'(z)$ of the analytic polynomials in (3). Show that in each case $P'(z) = P_x$. Explain.
- Prove Proposition 2.5 by arguments analogous to those of real-variable calculus.
- Prove Proposition 2.6. [Hint: Prove it for monomials and apply Proposition 2.5.]
- Show $S_n = n^{1/n} \rightarrow 1$ as $n \rightarrow \infty$ by considering $\log S_n$.
- Find the radius of convergence of the following power series:
 - $\sum_{n=0}^{\infty} z^{n!}$,
 - $\sum_{n=0}^{\infty} (n + 2^n) z^n$.
- Suppose $\sum c_n z^n$ has radius of convergence R . Find the radius of convergence of
 - $\sum n^p c_n z^n$,
 - $\sum |c_n| z^n$,
 - $\sum c_n^2 z^n$.

11. Suppose $\sum a_n z^n$ and $\sum b_n z^n$ have radii of convergence R_1 and R_2 , respectively. What can be said about the radius of convergence of $\sum (a_n + b_n)z^n$? Show, by example, that the radius of convergence of the latter may be greater than R_1 and R_2 .
12. Show that $\sum_{n=1}^{\infty} (z^n/n)$ converges at all points on the unit circle except $z = 1$. [*Hint*: Let $z = \text{cis } \theta$ and analyze the real and imaginary parts of the series separately.]
13. a. Suppose $\{a_n\}$ is a sequence of positive real numbers and

$$\lim_{n \rightarrow \infty} \frac{a_{n+1}}{a_n} = L.$$

Show then that $\lim_{n \rightarrow \infty} a_n^{1/n} = L$.

- b. Use the result above to prove

$$\left(\frac{1}{n!}\right)^{1/n} \rightarrow 0.$$

14. Use Exercise (13a) to find the radius of convergence of

a. $\sum_{n=0}^{\infty} \frac{(-1)^n z^n}{n!},$	b. $\sum_{n=0}^{\infty} \frac{z^{2n+1}}{(2n+1)!},$
c. $\sum_{n=1}^{\infty} \frac{n! z^n}{n^n},$	d. $\sum_{n=0}^{\infty} \frac{2^n z^n}{n!}.$

- 15.* Find the radius of convergence of

a. $\sum \sin n z^n,$	b. $\sum e^{-n^2} z^n,$
-----------------------	-------------------------

- 16.* Find the radius of convergence of $\sum c_n z^n$ if $c_{2k} = 2^k$; $c_{2k-1} = (1 + 1/k)^{k^2}$, $k = 1, 2, \dots$

17. Suppose $\sum_{k=0}^{\infty} a_k = A$ and $\sum_{k=0}^{\infty} b_k = B$. Suppose further that each of the series is absolutely convergent. Show that if

$$c_k = \sum_{j=0}^k a_j b_{k-j}$$

then

$$\sum_{k=0}^{\infty} c_k = AB.$$

Outline: Use the fact that $\sum |a_k|$ and $\sum |b_k|$ converge to show that $\sum d_k$ converges where

$$d_k = \sum_{j=0}^k |a_j| |b_{k-j}|.$$

In particular,

$$d_{n+1} + d_{n+2} + \dots \rightarrow 0 \text{ as } n \rightarrow \infty.$$

Note then that if

$$\begin{aligned} A_n &= a_0 + a_1 + \dots + a_n \\ B_n &= b_0 + b_1 + \dots + b_n \\ C_n &= c_0 + c_1 + \dots + c_n, \end{aligned}$$

$A_n B_n = C_n + R_n$, where $|R_n| \leq d_{n+1} + d_{n+2} + \dots + d_{2n}$, and the result follows by letting $n \rightarrow \infty$.

18. Suppose $\sum a_n z^n$ and $\sum b_n z^n$ have radii of convergence R_1 and R_2 respectively. Show that the Cauchy product $\sum c_n z^n$ converges for $|z| < \min(R_1, R_2)$.

19. a. Using the identity

$$(1 - z)(1 + z + z^2 + \cdots + z^N) = 1 - z^{N+1}$$

show that

$$\sum_{n=0}^{\infty} z^n = \frac{1}{1 - z} \text{ for } |z| < 1.$$

- b. By taking the Cauchy product of $\sum_{n=0}^{\infty} z^n$ with itself, find a closed form for $\sum_{n=0}^{\infty} n z^n$.
20. Prove Corollary 2.13 by showing that if a set S has an accumulation point at 0, it contains a sequence of nonzero terms which converge to 0.
21. Show that there is no power series $f(z) = \sum_{n=0}^{\infty} C_n z^n$ such that
- $f(z) = 1$ for $z = \frac{1}{2}, \frac{1}{3}, \frac{1}{4}, \dots$,
 - $f'(0) > 0$.
22. Assume $\overline{\lim} |C_n|^{1/n} < \infty$. Show that if we set

$$f(z) = \sum_{n=0}^{\infty} C_n (z - a)^n,$$

then

$$C_n = \frac{f^{(n)}(a)}{n!}.$$

23. Find the domain of convergence of

- $\sum_{n=0}^{\infty} n(z - 1)^n$,
- $\sum_{n=0}^{\infty} \frac{(-1)^n}{n!} (z + 1)^n$,
- $\sum_{n=0}^{\infty} n^2 (2z - 1)^n$.

Chapter 3

Analytic Functions

3.1 Analyticity and the Cauchy-Riemann Equations

The direct functions of z which we have studied so far—polynomials and convergent power series—were shown to be differentiable functions of z . We now take a closer look at the property of differentiability and its relation to the Cauchy-Riemann equations.

As we mentioned earlier (after Definition 2.4), if f is differentiable,

$$\lim_{h \rightarrow 0} \frac{f(z+h) - f(z)}{h}$$

must exist regardless of the manner in which h approaches 0 through complex values. An immediate consequence is that the partial derivatives of f must satisfy the Cauchy-Riemann equations.

3.1 Proposition

If $f = u + iv$ is differentiable at z , f_x and f_y exist there and satisfy the Cauchy-Riemann equation

$$f_y = if_x$$

or, equivalently,

$$\begin{aligned}u_x &= v_y \\ u_y &= -v_x.\end{aligned}$$

Proof

Suppose first that $h \rightarrow 0$ through real values. Then

$$\frac{f(z+h) - f(z)}{h} = \frac{f(x+h, y) - f(x, y)}{h} \rightarrow f_x.$$

On the other hand, if $h \rightarrow 0$ along the imaginary axis, $h = i\eta$ and

$$\frac{f(z+h) - f(z)}{h} = \frac{f(x, y + \eta) - f(x, y)}{i\eta} \rightarrow \frac{f_y}{i}.$$

(See Exercise 1.) Since the two limits must be equal,

$$f_y = if_x.$$

As we mentioned in Chapter 2, setting $f = u + iv$, the equation $f_y = if_x$ takes the form

$$u_y + iv_y = i(u_x + iv_x)$$

and hence

$$u_x = v_y$$

$$u_y = -v_x.$$

□

The converse of the above proposition is not true. There are functions which are not differentiable at a point despite the fact that the partial derivatives exist and satisfy the Cauchy-Riemann equations there.

For example, consider

$$f(z) = f(x, y) = \begin{cases} \frac{xy(x+iy)}{x^2+y^2} & z \neq 0 \\ 0 & z = 0. \end{cases}$$

$f = 0$ on both axes so that $f_x = f_y = 0$ at the origin but

$$\lim_{z \rightarrow 0} \frac{f(z) - f(0)}{z} = \lim_{(x,y) \rightarrow (0,0)} \frac{xy}{x^2 + y^2}$$

does not exist. For on the line $y = \alpha x$

$$\frac{f(z) - f(0)}{z} \equiv \frac{\alpha}{1 + \alpha^2} \quad \text{for } z \neq 0$$

and hence the limit depends on α !

The following partial converse, however, is true.

3.2 Proposition

Suppose f_x and f_y exist in a neighborhood of z . Then if f_x and f_y are continuous at z and $f_y = if_x$ there, f is differentiable at z .

Proof

Let $f = u + iv$, $h = \zeta + i\eta$.

We will show that

$$\frac{f(z+h) - f(z)}{h} \rightarrow f_x(z) = u_x(z) + iv_x(z)$$

as $h \rightarrow 0$. By the Mean-Value Theorem (for real functions of a real variable)

$$\begin{aligned} \frac{u(z+h) - u(z)}{h} &= \frac{u(x+\zeta, y+\eta) - u(x, y)}{\zeta + i\eta} \\ &= \frac{u(x+\zeta, y+\eta) - u(x+\zeta, y)}{\zeta + i\eta} \\ &\quad + \frac{u(x+\zeta, y) - u(x, y)}{\zeta + i\eta} \\ &= \frac{\eta}{\zeta + i\eta} u_y(x+\zeta, y+\theta_1\eta) \\ &\quad + \frac{\zeta}{\zeta + i\eta} u_x(x+\theta_2\zeta, y), \end{aligned}$$

and

$$\begin{aligned} \frac{v(z+h) - v(z)}{h} &= \frac{\eta}{\zeta + i\eta} v_y(x+\zeta, y+\theta_3\eta) \\ &\quad + \frac{\zeta}{\zeta + i\eta} v_x(x+\theta_4\zeta, y) \end{aligned}$$

for some θ_k ,

$$0 < \theta_k < 1, \quad k = 1, 2, 3, 4.$$

Thus

$$\begin{aligned} \frac{f(z+h) - f(z)}{h} &= \frac{\eta}{\zeta + i\eta} [u_y(z_1) + iv_y(z_2)] \\ &\quad + \frac{\zeta}{\zeta + i\eta} [u_x(z_3) + iv_x(z_4)] \end{aligned}$$

where $|z_k - z| \rightarrow 0$ as $h \rightarrow 0$, $k = 1, 2, 3, 4$. Since $f_y = if_x$ at z we can subtract $f_x(z)$ in the form of

$$\frac{\eta}{\zeta + i\eta} f_y + \frac{\zeta}{\zeta + i\eta} f_x$$

to obtain

$$\begin{aligned} \frac{f(z+h) - f(z)}{h} - f_x(z) &= \frac{\eta}{\zeta + i\eta} [(u_y(z_1) - u_y(z)) + i(v_y(z_2) - v_y(z))] \\ &\quad + \frac{\zeta}{\zeta + i\eta} [(u_x(z_3) - u_x(z)) + i(v_x(z_4) - v_x(z))]. \end{aligned}$$

Finally, since

$$\left| \frac{\eta}{\xi + i\eta} \right|, \left| \frac{\xi}{\xi + i\eta} \right| \leq 1,$$

while each of the bracketed expressions approaches 0 as $h \rightarrow 0$,

$$\lim_{h \rightarrow 0} \frac{f(z+h) - f(z)}{h} = f_x(z).$$

□

EXAMPLE

Let $f(z) = |z|^2 = x^2 + y^2$. Then $f_x = 2x$, $f_y = 2y$ so that f has continuous partial derivatives for all z . By the previous proposition, then f is differentiable if and only if $f_y = if_x$. Hence f is differentiable only at the point $z = 0$. \diamond

To avoid pathologies such as that given in the example above, we adopt the following definition.

3.3 Definition

f is *analytic at z* if f is differentiable in a neighborhood of z . Similarly, f is *analytic on a set S* if f is differentiable at all points of some open set containing S .

Note that this definition is consistent with Definition 2.1 for analytic polynomials. For we have already noted (Proposition 2.6) that “polynomials in z ” are everywhere differentiable. Conversely, if a polynomial P is analytic at a point z , its partial derivatives must satisfy the Cauchy-Riemann equations throughout a neighborhood of z . Hence, as in Proposition 2.3, it follows that P must be a “polynomial in z .”

Functions, such as polynomials or everywhere convergent power series, that are everywhere differentiable are called *entire* functions.

As we saw in Propositions 2.5 and 2.6, many of the properties of differentiability are analogous to those of differentiable functions of a real variable. Similarly, the composition of differentiable functions is differentiable (see Exercise 3). As in the “real” case, the inverse of a differentiable function need not even be continuous. Under the appropriate hypothesis, however, we can establish the differentiability of inverse functions.

3.4 Definition

Suppose that S and T are open sets and that f is 1-1 on S with $f(S) = T$. g is the *inverse of f on T* if $f(g(z)) = z$ for $z \in T$. g is the *inverse of f at z_0* if g is the inverse of f in some neighborhood of z_0 .

Note that an inverse function must be 1-1 for if $f^{-1}(z) = f^{-1}(z_0)$, $f(f^{-1}(z)) = f(f^{-1}(z_0))$; *i.e.*, $z = z_0$.

3.5 Proposition

Suppose that g is the inverse of f at z_0 and that g is continuous there. If f is differentiable at $g(z_0)$ and if $f'(g(z_0)) \neq 0$, then g is differentiable at z_0 and

$$g'(z_0) = \frac{1}{f'(g(z_0))}.$$

Proof

$$\frac{g(z) - g(z_0)}{z - z_0} = \frac{1}{\frac{f(g(z)) - f(g(z_0))}{g(z) - g(z_0)}}$$

for all $z \neq z_0$ in a neighborhood of z_0 . Since g is continuous at z_0 , $g(z) \rightarrow g(z_0)$ as $z \rightarrow z_0$, and by the differentiability of f ,

$$\lim_{z \rightarrow z_0} \frac{g(z) - g(z_0)}{z - z_0} = \frac{1}{f'(g(z_0))}.$$

□

As we shall see in the coming chapters, the property of analyticity is a very far-reaching one. Some immediate consequences are proven below.

3.6 Proposition

If $f = u + iv$ is analytic in a region D and u is constant, then f is constant.

Proof

Since u is constant, $u_x = u_y = 0$; therefore, by the Cauchy-Riemann equations, $v_x = v_y = 0$. According to Theorem 1.10, u and v are each constant in D ; hence f is constant. □

3.7 Proposition

If f is analytic in a region and if $|f|$ is constant there, then f is constant.

Proof

If $|f| = 0$, the proof is immediate. Otherwise

$$u^2 + v^2 \equiv C \neq 0.$$

Taking the partial derivatives with respect to x and y , we see that

$$uu_x + vv_x \equiv 0$$

$$uu_y + vv_y \equiv 0.$$

Making use of the Cauchy-Riemann equations, we obtain

$$\begin{aligned}uu_x - v u_y &\equiv 0 \\v u_x + u u_y &\equiv 0,\end{aligned}$$

so that

$$(u^2 + v^2)u_x \equiv 0$$

and $u_x = v_y \equiv 0$. Similarly, u_y and v_x are identically zero, hence f is constant. \square

3.2 The Functions e^z , $\sin z$, $\cos z$

We wish to define an exponential function of the complex variable z ; that is, we seek an analytic function f such that

$$f(z_1 + z_2) = f(z_1)f(z_2), \quad (1)$$

$$f(x) = e^x \quad \text{for all real } x. \quad (2)$$

According to (1) and (2) we must have

$$f(z) = f(x + iy) = f(x)f(iy) = e^x f(iy).$$

Setting $f(iy) = A(y) + iB(y)$, it follows that

$$f(z) = e^x A(y) + i e^x B(y).$$

For f to be analytic, the Cauchy-Riemann equations must be satisfied; therefore $A(y) = B'(y)$ and $A'(y) = -B(y)$, so that $A'' = -A$. Thus we consider

$$A(y) = \alpha \cos y + \beta \sin y$$

$$B(y) = -A'(y) = -\beta \cos y + \alpha \sin y.$$

Since $f(x) = e^x$, however, $A(0) = \alpha = 1$ and $B(0) = -\beta = 0$, so that, finally, we are led to examine

$$f(z) = e^x \cos y + i e^x \sin y.$$

Indeed, it is easy to verify that f is an entire function with the desired properties (1) and (2). (See Exercise 11.) Hence f is an entire “extension” of the real exponential function and we write $f(z) = e^z$.

The following properties of e^z are easily proven:

- i. $|e^z| = e^x$.
- ii. $e^z \neq 0$.

This follows from (i) since $e^x \neq 0$. Also, according to (1), above, $e^z e^{-z} = e^0 = 1$.

- iii. $e^{iy} = \text{cis } y$.

- iv. $e^z = \alpha$ has infinitely many solutions for any $\alpha \neq 0$.

Proof

Set $\alpha = r \operatorname{cis} \theta = r e^{i\theta}$, $r > 0$. Since $e^z = e^x e^{iy}$, we will have $e^z = \alpha$ if $x = \log r$ and $e^{iy} = e^{i\theta}$. Hence $e^z = \alpha$ for all points $z = x + iy$ with $x = \log r$, $y = \operatorname{Arg} \alpha = \theta \pm 2k\pi$, $k = 0, 1, 2, \dots$ \square

v. $(e^z)' = e^z$.

Recall that $(e^z)' = (e^z)_x = e^z$.

To define $\sin z$ and $\cos z$, note that for real y

$$e^{iy} = \cos y + i \sin y$$

$$e^{-iy} = \cos y - i \sin y$$

so that

$$\sin y = \frac{1}{2i}(e^{iy} - e^{-iy})$$

and

$$\cos y = \frac{1}{2}(e^{iy} + e^{-iy}).$$

Thus we can define entire extensions of $\sin x$ and $\cos x$ by setting

$$\sin z = \frac{1}{2i}(e^{iz} - e^{-iz})$$

$$\cos z = \frac{1}{2}(e^{iz} + e^{-iz}).$$

Many of the familiar properties of the \sin and \cos functions remain valid in the larger setting of the complex plane. For example,

$$\sin 2z = 2 \sin z \cos z$$

$$\sin^2 z + \cos^2 z = 1$$

$$(\sin z)' = \cos z.$$

These identities are easily verified and are left as an exercise. Moreover, in Section 6.3, we will see that, in general, functional equations of the above form, known to be true on the real axis, remain valid throughout the complex plane.

On the other hand, unlike $\sin x$, $\sin z$ is not bounded in modulus by 1. For example, $|\sin 10i| = \frac{1}{2}(e^{10} - e^{-10}) > 10,000$.

Exercises

1. Show that

$$f_x = \lim_{\substack{h \rightarrow 0 \\ h \text{ real}}} \frac{f(z+h) - f(z)}{h}; \quad f_y = \lim_{\substack{h \rightarrow 0 \\ h \text{ real}}} \frac{f(z+ih) - f(z)}{h},$$

provided the limits exist.

2. a. Show that $f(z) = x^2 + iy^2$ is differentiable at all points on the line $y = x$.
b. Show that it is nowhere analytic.
3. Prove that the composition of differentiable functions is differentiable. That is, if f is differentiable at z , and if g is differentiable at $f(z)$, then $g \circ f$ is differentiable at z . [Hint: Begin by noting

$$g(f(z+h)) - g(f(z)) = [g'(f(z)) + \epsilon][f(z+h) - f(z)]$$

where $\epsilon \rightarrow 0$ as $h \rightarrow 0$.]

4. Suppose that g is a continuous “ $\sqrt{}$ ” (i.e., $g^2(z) = z$) in some neighborhood of z . Verify that $g'(z) = 1/2\sqrt{z}$. [Hint: Use

$$1 = \frac{g^2(z) - g^2(z_0)}{z - z_0}$$

to evaluate

$$\lim_{z \rightarrow z_0} \frac{g(z) - g(z_0)}{z - z_0}.]$$

5. Suppose f is analytic in a region and $f' \equiv 0$ there. Show that f is constant.
6. Assume that f is analytic in a region and that at every point, either $f = 0$ or $f' = 0$. Show that f is constant. [Hint: Consider f^2 .]
7. Show that a nonconstant analytic function cannot map a region into a straight line or into a circular arc.
8. Find all analytic functions $f = u + iv$ with $u(x, y) = x^2 - y^2$.
9. Show that there are no analytic functions $f = u + iv$ with $u(x, y) = x^2 + y^2$.
10. Suppose f is an entire function of the form

$$f(x, y) = u(x) + iv(y).$$

Show that f is a linear polynomial.

11. a. Show that e^z is entire by verifying the Cauchy-Riemann equations for its real and imaginary parts.
b. Prove:

$$e^{z_1+z_2} = e^{z_1} e^{z_2}.$$

12. Show: $|e^z| = e^x$.
13. Discuss the behavior of e^z as $z \rightarrow \infty$ along the various rays from the origin.
14. Find all solutions of

a. $e^z = 1$,	b. $e^z = i$,
c. $e^z = -3$,	d. $e^z = 1 + i$.

15. Verify the identities

- a. $\sin 2z = 2 \sin z \cos z$,
- b. $\sin^2 z + \cos^2 z = 1$,
- c. $(\sin z)' = \cos z$.

- 16.* Show that

- a. $\sin(\frac{\pi}{2} + iy) = \frac{1}{2}(e^y + e^{-y}) = \cosh y$
- b. $|\sin z| \geq 1$ at all points on the square with vertices $\pm(N + \frac{1}{2})\pi \pm (N + \frac{1}{2})\pi i$, for any positive integer N .
- c. $|\sin z| \rightarrow \infty$, as $\text{Im} z = y \rightarrow \pm\infty$.

17. Find $(\cos z)'$.

18. Find $\sin^{-1}(2)$ —that is, find the solutions of $\sin z = 2$. [*Hint*: First set $w = e^{iz}$ and solve for w .]

19.* Find all solutions of the equation:

$$e^{e^z} = 1.$$

20. Show that $\sin(x + iy) = \sin x \cosh y + i \cos x \sinh y$.

21. Show that the power series

$$f(z) = 1 + z + \frac{z^2}{2!} + \dots = \sum_{n=0}^{\infty} \frac{z^n}{n!}$$

is equal to e^z . [*Hint*: First show that $f(z)f(w) = f(z+w)$, then show

$$f(x) = e^x$$

$$f(iy) = \cos y + i \sin y$$

using the power series representations for the real functions

$$e^x, \cos x, \sin x.]$$

22. Show:

$$g(z) = z - \frac{z^3}{3!} + \frac{z^5}{5!} - + \dots$$

is equal to $\sin z$. [*Hint*: Use the power series representation for e^z given in (21) to show that

$$g(z) = \frac{1}{2i}(e^{iz} - e^{-iz}).]$$

23. Find a power series representation for $\cos z$.

Chapter 4

Line Integrals and Entire Functions

Introduction

Recall that, according to Theorem 2.9, an everywhere convergent power series represents an entire function. Our main goal in the next two chapters is the somewhat surprising converse of that result: namely, that *every* entire function can be expanded as an everywhere convergent power series. As an immediate corollary, we will be able to prove that every entire function is infinitely differentiable. To arrive at these results, however, we must begin by discussing integrals rather than derivatives.

4.1 Properties of the Line Integral

4.1 Definition

Let $f(t) = u(t) + iv(t)$ be any continuous complex-valued function of the real variable t , $a \leq t \leq b$.

$$\int_a^b f(t)dt = \int_a^b u(t)dt + i \int_a^b v(t)dt.$$

4.2 Definition

- a. Let $z(t) = x(t) + iy(t)$, $a \leq t \leq b$. The curve determined by $z(t)$ is called *piecewise differentiable* and we set

$$\dot{z}(t) = x'(t) + iy'(t)$$

if x and y are continuous on $[a, b]$ and continuously differentiable on each subinterval $[a, x_1]$, $[x_1, x_2]$, \dots , $[x_{n-1}, b]$ of some partition of $[a, b]$.

- b. The curve is said to be *smooth* if, in addition, $\dot{z}(t) \neq 0$ (i.e., $x'(t)$ and $y'(t)$ do not both vanish) except at a finite number of points.

Throughout the remainder of the text, all curves will be assumed to be smooth unless otherwise stated.

Finally, we define the important concept of a line integral.

4.3 Definition

Let C be a smooth curve given by $z(t)$, $a \leq t \leq b$, and suppose f is continuous at all the points $z(t)$. Then, the *integral of f along C* is

$$\int_C f(z) dz = \int_a^b f(z(t)) \dot{z}(t) dt.$$

Note that the integral along the curve C depends not only on the points of C but on the direction as well. However, we will show that it is independent of the particular parametrization. Intuitively, if $z(t)$, $a \leq t \leq b$, and $\omega(t)$, $c \leq t \leq d$, trace the same curve in the same direction, then $\lambda = z^{-1} \circ \omega$ will be a 1-1 mapping of $[c, d]$ onto $[a, b]$ such that

$$\omega(t) = z(\lambda(t)). \quad (1)$$

However, if z is not 1-1, it is difficult to define z^{-1} . Instead, we take the existence of some λ that satisfies (1) as the definition for equivalent curves.

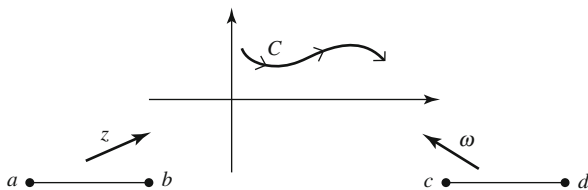

4.4 Definition

The two curves

$$C_1 : z(t), \quad a \leq t \leq b$$

and

$$C_2 : \omega(t), \quad c \leq t \leq d$$

are *smoothly equivalent* if there exists a 1-1 C^1 mapping $\lambda(t) : [c, d] \rightarrow [a, b]$ such that $\lambda(c) = a$, $\lambda(d) = b$, $\lambda'(t) > 0$ for all t , and

$$\omega(t) = z(\lambda(t)).$$

(It is easy to verify that the above is an equivalence relation. See Exercise 1.)

4.5 Proposition

If C_1 and C_2 are smoothly equivalent, then

$$\int_{C_1} f = \int_{C_2} f.$$

Proof

Suppose $f(z) = u(z) + iv(z)$, C_1 and C_2 as above. Then, by definition

$$\begin{aligned} \int_{C_1} f &= \int_a^b u(z(t))x'(t)dt - \int_a^b v(z(t))y'(t)dt \\ &\quad + i \int_a^b u(z(t))y'(t)dt + i \int_a^b v(z(t))x'(t)dt \end{aligned} \quad (1)$$

while

$$\int_{C_2} f = \int_c^d [u(z(\lambda(t))) + iv(z(\lambda(t)))] [x'(\lambda(t)) + iy'(\lambda(t))] \lambda'(t) dt. \quad (2)$$

Expanding the integrand in (2) and analyzing the four terms separately, we find that they are exactly equal to the four corresponding terms in (1).

For example

$$\int_c^d u(z(\lambda(t)))x'(\lambda(t))\lambda'(t)dt = \int_a^b u(z(t))x'(t)dt,$$

by the change-of-variable theorem for ordinary real integrals, and the proof is complete. \square

The following proposition points out the dependence of the line integral on the direction of the curve.

4.6 Definition

Suppose C is given by $z(t)$, $a \leq t \leq b$. Then $-C$ is defined by $z(b + a - t)$, $a \leq t \leq b$. (Intuitively, $-C$ is the point set of C traced in the opposite direction.)

4.7 Proposition

$$\int_{-C} f = - \int_C f.$$

Proof

$$\int_{-C} f = - \int_a^b f(z(b + a - t)) \dot{z}(b + a - t) dt.$$

Again, expanding the integral into real and imaginary parts and applying the change-of-variable theorem to each (real) integral, we find

$$\int_{-C} f = \int_b^a f(z(t)) \dot{z}(t) dt = - \int_C f. \quad \square$$

EXAMPLE 1

Suppose $f(z) = x^2 + iy^2$ (where x and y denote the real and imaginary parts of z , respectively), and consider

$$C : z(t) = t + it, \quad 0 \leq t \leq 1.$$

Then

$$\dot{z}(t) = 1 + i$$

and

$$\int_C f(z) dz = \int_0^1 (t^2 + it^2)(1 + i) dt = (1 + i)^2 \int_0^1 t^2 dt = 2i/3.$$

◇

EXAMPLE 2

Let

$$f(z) = \frac{1}{z} = \frac{x}{x^2 + y^2} - i \frac{y}{x^2 + y^2},$$

and set

$$C : z(t) = R \cos t + i R \sin t, \quad 0 \leq t \leq 2\pi, \quad R \neq 0.$$

Then

$$\begin{aligned} \int_C f(z) dz &= \int_0^{2\pi} \left(\frac{\cos t}{R} - i \frac{\sin t}{R} \right) (-R \sin t + i R \cos t) dt \\ &= \int_0^{2\pi} i dt = 2\pi i \quad (\text{See Exercise 8.}) \end{aligned}$$

That is, the integral of $1/z$ around any circle centered at the origin (traversed counterclockwise) is $2\pi i$. ◇

EXAMPLE 3

Suppose $f(z) \equiv 1$, and let C be any smooth curve. Then

$$\int_C f(z) dz = \int_a^b \dot{z}(t) dt = z(b) - z(a).$$

◇

The integrals defined above are natural generalizations of the definite integral and, not too surprisingly, they share many of the same properties.

4.8 Proposition

Let C be a smooth curve; let f and g be continuous functions on C ; and let a be any complex number. Then

$$\text{I. } \int_C [f(z) + g(z)]dz = \int_C f(z)dz + \int_C g(z)dz$$

$$\text{II. } \int_C af(z)dz = a \int_C f(z)dz.$$

ProofExercise 4. □

Notation: If α and β are complex numbers, the symbol $\alpha \ll \beta$ will be used to denote the inequality $|\alpha| \leq |\beta|$.

4.9 Lemma

Suppose $G(t)$ is a continuous complex-valued function of t . Then

$$\int_a^b G(t)dt \ll \int_a^b |G(t)|dt.$$

Proof

Suppose

$$\int_a^b G(t)dt = Re^{i\theta}, R \geq 0. \quad (1)$$

By Proposition 4.8, then

$$\int_a^b e^{-i\theta} G(t)dt = R. \quad (2)$$

Suppose further that $e^{-i\theta} G(t) = A(t) + iB(t)$, with A and B real-valued. Then, according to (2),

$$R = \int_a^b A(t)dt = \int_a^b \operatorname{Re}(e^{-i\theta} G(t))dt.$$

But $\operatorname{Re} z \leq |\operatorname{Re} z| \leq |z|$, hence

$$R \leq \int_a^b |G(t)|dt. \quad (3)$$

A comparison of (1) and (3) then gives the desired result. □**4.10 M-L Formula**

Suppose that C is a (smooth) curve of length L , that f is continuous on C , and that $f \ll M$ throughout C . Then

$$\int_C f(z)dz \ll ML.$$

Proof

Suppose C is given by $z(t) = x(t) + iy(t)$, $a \leq t \leq b$. Then, by the previous lemma,

$$\int_C f(z)dz = \int_a^b f(z(t))\dot{z}dt \ll \int_a^b |f(z(t))\dot{z}(t)|dt.$$

According to the Mean-Value Theorem for Integrals applied to the positive functions $|f(z(t))|$ and $|\dot{z}(t)|$

$$\int_C f(z)dz \ll \max_{z \in C} |f(z)| \int_a^b |\dot{z}(t)|dt. \quad (4)$$

Finally, recall that for any curve given parametrically by $(x(t), y(t))$, $a \leq t \leq b$, the arc length L is given by

$$L = \int_a^b \sqrt{(x'(t))^2 + (y'(t))^2}dt = \int_a^b |\dot{z}(t)|dt,$$

so that according to (4) $\int_C f(z)dz \ll ML$. □

EXAMPLE

Let C be the unit circle and suppose $f \ll 1$ on C . Then $M = 1$, $L = 2\pi$, and

$$\int_C f(z)dz \ll 2\pi.$$

To see that the upper bound of 2π can actually be achieved, consider Example 2 above. ◇

4.11 Proposition

Suppose $\{f_n\}$ is a sequence of continuous functions and $f_n \rightarrow f$ uniformly on the smooth curve C . Then

$$\int_C f(z)dz = \lim_{n \rightarrow \infty} \int_C f_n(z)dz.$$

Proof

$$\int_C f(z)dz - \int_C f_n(z)dz = \int_C [f(z) - f_n(z)]dz$$

by Proposition 4.8. Taking n large enough so that $|f(z) - f_n(z)| < \epsilon$ for all $z \in C$, and applying Proposition 4.10, shows that

$$\int_C f(z) - \int_C f_n(z)dz \ll \epsilon \cdot (\text{length of } C)$$

for any pre-assigned $\epsilon > 0$, and hence that

$$\lim_{n \rightarrow \infty} \int_C f_n(z) dz = \int_C f(z) dz. \quad \square$$

The following generalization of the Fundamental Theorem of Calculus will be crucial in the development of this chapter.

4.12 Proposition

Suppose f is the derivative of an analytic function F —that is, $f(z) = F'(z)$, where F is analytic on the smooth curve C . Then

$$\int_C f(z) dz = F(z(b)) - F(z(a)).$$

Proof

The proof depends on a complex analogue of the chain-rule for differentiation. Letting

$$\gamma(t) = F(z(t)), \quad a \leq t \leq b,$$

we wish to show that

$$\dot{\gamma}(t) = f(z(t))\dot{z}(t)$$

at the all-but-finite number of points where $\dot{z}(t)$ exists and is nonzero.

Note first that for any smooth curve $\lambda(t)$, by considering the real and imaginary parts of λ separately, it is easily seen that

$$\dot{\lambda}(t) = \lim_{\substack{h \rightarrow 0 \\ h \text{ real}}} \frac{\lambda(t+h) - \lambda(t)}{h}.$$

Hence

$$\begin{aligned} \dot{\gamma}(t) &= \lim_{h \rightarrow 0} \frac{F(z(t+h)) - F(z(t))}{h} \\ &= \lim_{h \rightarrow 0} \frac{F(z(t+h)) - F(z(t))}{z(t+h) - z(t)} \cdot \frac{z(t+h) - z(t)}{h}. \end{aligned}$$

[Since $\dot{z}(t) \neq 0$, we can find $\delta > 0$ so that $|h| < \delta$ implies $z(t+h) - z(t) \neq 0$.]

Thus

$$\dot{\gamma}(t) = f(z(t))\dot{z}(t).$$

Proposition 4.12 follows then by noting that

$$\begin{aligned} \int_C f(z) dz &= \int_a^b f(z(t))\dot{z}(t) dt = \int_a^b \dot{\gamma}(t) dt \\ &= \gamma(b) - \gamma(a) = F(z(b)) - F(z(a)). \end{aligned} \quad \square$$

4.2 The Closed Curve Theorem for Entire Functions

4.13 Definition

A curve C is *closed* if its initial and terminal points coincide—i.e., if C is given by $z(t)$, $a \leq t \leq b$, with $z(a) = z(b)$. C is a *simple closed curve* if no other points coincide; i.e., if $z(t_1) = z(t_2)$ with $t_1 < t_2$ implies $t_1 = a$ and $t_2 = b$.

The following theorem is the first of several which show that, under rather general conditions, the integral of an analytic function along a closed curve is zero. Of course, Example 2 showed that this is not always the case. We begin cautiously, by considering entire functions.

Note: Throughout the text, *the boundary of a rectangle* will mean a simple closed curve parametrized so that the rectangle it bounds lies on the left as the curve is traced out for increasing t .

4.14 Rectangle Theorem

Suppose f is entire and Γ is the boundary of a rectangle R . Then

$$\int_{\Gamma} f(z) dz = 0.$$

Lemma

If f is a linear function and if Γ is as above, then

$$\int_{\Gamma} f(z) dz = 0.$$

Proof of Lemma

Let $f(z) = \alpha + \beta z$ and let Γ be given by

$$\Gamma : z(t), \quad a \leq t \leq b.$$

Since $f(z)$ is everywhere the derivative of the analytic function $F(z) = \alpha z + \beta z^2/2$,

$$\int_{\Gamma} f(z) dz = \int_{\Gamma} F'(z) dz = F(z(b)) - F(z(a)) = 0$$

by Proposition 4.12 and the observation that Γ is a closed curve. (An alternate, more direct proof is outlined in Exercise 7.) \square

Proof of Theorem 4.14

Let $\int_{\Gamma} f(z) dz = I$. To show that $I = 0$, we use the method of continued bisection. That is, we split the rectangle R into four congruent subrectangles, by

bisecting each of the sides. If we let $\Gamma_1, \Gamma_2, \Gamma_3, \Gamma_4$ denote the boundaries of the four subrectangles

$$\int_{\Gamma} f = \sum_{i=1}^4 \int_{\Gamma_i} f$$

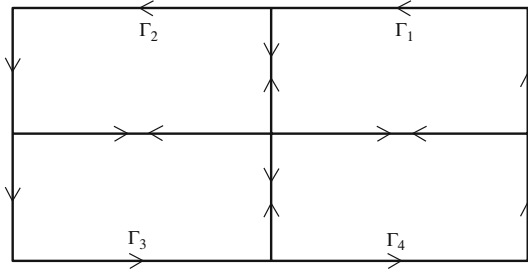

since the integrals along the interior lines appear in opposite directions and thus cancel, by Proposition 4.7. Hence for some $\Gamma_k, 1 \leq k \leq 4$, which we will denote $\Gamma^{(1)}$,

$$\int_{\Gamma^{(1)}} f(z) dz \gg \frac{I}{4}.$$

Let $R^{(1)}$ be the rectangle bounded by $\Gamma^{(1)}$. Continuing in this manner, dividing $R^{(k)}$ into four congruent rectangles, we obtain a sequence of rectangles

$$R^{(1)} \supset R^{(2)} \supset R^{(3)} \supset \dots$$

and their boundaries

$$\Gamma^{(1)}, \Gamma^{(2)}, \Gamma^{(3)}, \dots$$

such that $\text{diam } R^{(k+1)} = \frac{1}{2} \text{diam } R^{(k)}$ and such that

$$\int_{\Gamma^{(k)}} f(z) dz \gg \frac{I}{4^k}. \tag{1}$$

Let $z_0 \in \bigcap_{k=1}^{\infty} R^{(k)}$. The proof will follow by considering the analyticity of f at z_0 . That is, since

$$\frac{f(z) - f(z_0)}{z - z_0} \rightarrow f'(z_0)$$

we can write

$$f(z) = f(z_0) + f'(z_0)(z - z_0) + \epsilon_z(z - z_0)$$

where $\epsilon_z \rightarrow 0$ as $z \rightarrow z_0$.

Note, then, that

$$\begin{aligned} \int_{\Gamma^{(n)}} f(z) dz &= \int_{\Gamma^{(n)}} [f(z_0) + f'(z_0)(z - z_0) + \epsilon_z \cdot (z - z_0)] dz \\ &= \int_{\Gamma^{(n)}} \epsilon_z \cdot (z - z_0) dz \quad \text{by the lemma.} \end{aligned}$$

To estimate the integral, let us assume that the largest side of the original boundary Γ was of length s . Then, by elementary geometric considerations,

$$\int_{\Gamma^{(n)}} |dz| = \text{length of } \Gamma^{(n)} \leq \frac{4s}{2^n}$$

and

$$|z - z_0| \leq \frac{\sqrt{2} \cdot s}{2^n} \quad \text{for all } z \in \Gamma^{(n)}.$$

Given $\epsilon > 0$, we choose N so that

$$|z - z_0| \leq \frac{\sqrt{2} \cdot s}{2^N} \quad \text{implies that } \epsilon_z \ll \epsilon.$$

Then for $n \geq N$, we have by the M - L formula (Proposition 4.10)

$$\int_{\Gamma^{(n)}} f(z) dz \ll \epsilon \cdot \frac{4\sqrt{2}s^2}{4^n}. \quad (2)$$

A combination of (1) and (2) shows that for $n \geq N$

$$\frac{I}{4^n} \ll \epsilon \frac{4\sqrt{2}s^2}{4^n}$$

or

$$I \ll \epsilon \cdot 4\sqrt{2}s^2.$$

Since this holds for all $\epsilon > 0$, we may conclude that $I = 0$. □

Note: Although the orientation of Γ was chosen to be counterclockwise, the same result would hold with the opposite orientation. This follows from Proposition 4.7. The counterclockwise orientation was chosen primarily to fix a direction. In later chapters, we will see that the counterclockwise direction along the boundary is also the more “natural” one in a sense for functions analytic inside a region. Hence, unless otherwise specified, the integral around any convex curve will always be taken in the counterclockwise direction.

4.15 Integral Theorem

If f is entire, then f is everywhere the derivative of an analytic function. That is, there exists an entire F such that $F'(z) = f(z)$ for all z .

Proof

We define $F(z)$ as

$$\int_0^z f(\zeta) d\zeta$$

where \int_0^z denotes the integral along the straight lines from 0 to $\text{Re } z$ and from $\text{Re } z$ to z .

Note that

$$F(z+h) = F(z) + \int_z^{z+h} f(\zeta) d\zeta$$

where the integral denotes the integral along the line segments from z to $z + \operatorname{Re} h$ and from $z + \operatorname{Re} h$ to $z + h$. This follows since the difference between the two approaches is equal to the integral of f around a closed rectangle and is thus equal to zero. (See diagrams below.)

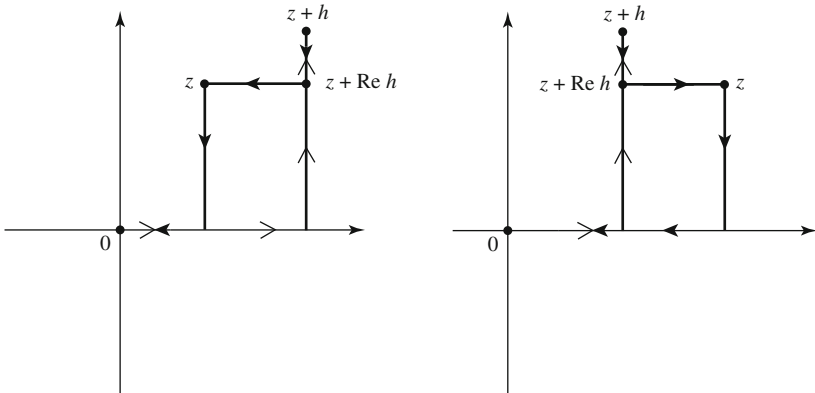

Hence

$$F(z+h) - F(z) = \int_z^{z+h} f(\zeta) d\zeta$$

and since

$$\frac{1}{h} \int_z^{z+h} 1 dz = \frac{1}{h} (z+h-z) = 1,$$

(see Example 3 after Proposition 4.7)

$$\frac{F(z+h) - F(z)}{h} - f(z) = \frac{1}{h} \int_z^{z+h} [f(\zeta) - f(z)] d\zeta.$$

Finally, for each $\epsilon \geq 0$, if h is small enough, $|f(\zeta) - f(z)| \ll \epsilon$ throughout the path of integration. Applying the M - L formula, we obtain

$$\frac{F(z+h) - F(z)}{h} - f(z) \ll \frac{1}{h} \cdot 2h\epsilon = 2\epsilon.$$

Hence

$$F'(z) = f(z).$$

□

4.16 Closed Curve Theorem

If f is entire and if C is a (smooth) closed curve,

$$\int_C f(z) dz = 0.$$

Proof

Since f is entire, by the Integral Theorem $f(z) = F'(z)$ for some entire function F so that

$$\int_C f(z) dz = \int_C F'(z) dz = F(z(b)) - F(z(a))$$

by Proposition 4.12. Since C is closed, $z(b) = z(a)$, $F(z(b)) = F(z(a))$, and

$$\int_C f(z) dz = 0.$$

□

Remarks

While Theorem 4.16 was proven for entire functions f , the only fact we needed was that $f(z)$ is the derivative of an analytic function on C . Thus, for example,

$$\int_C \frac{1}{z^2} dz = 0$$

if C is any smooth closed curve not passing through the origin. For although $1/z^2$ is not entire, it is the derivative of $F(z) = -1/z$ which is analytic except at the origin. Similarly,

$$\int_C z^k dz = 0$$

if k is any integer except -1 . Recall Example 2 which showed that $k = -1$ is an exception to the above. (See Exercise 8.)

Exercises

1. Prove that “equivalence” of smooth curves has the familiar reflexive, symmetric, and transitive properties of an equivalence relation.
2. Evaluate $\int_C f$ where $f(z) = x^2 + iy^2$ as in Example 1, but where C is given by $z(t) = t^2 + it^2$, $0 \leq t \leq 1$.
3. Evaluate $\int_C f$ where $f(z) = 1/z$ as in Example 2, and C is given by $z(t) = \sin t + i \cos t$, $0 \leq t \leq 2\pi$. Why is the result different from that of Example 2?
4. Prove Proposition 4.8. [*Hint*: Divide the integrals into real and imaginary parts.]
5. Prove the uniqueness of the integral. That is, show that $F' \equiv 0$ implies that F is a constant. [*Hint*: Use Proposition 4.12 to get an expression for $F(b) - F(a)$.]

6. Show that, if f is a continuous *real-valued* function and $f \ll 1$, then

$$\int_{|z|=1} f \ll 4.$$

[Hint: Show that $\int f \ll \int_0^{2\pi} |\sin t| dt$.]

7. Give a direct proof of the lemma to Theorem 4.14. That is, given any rectangle with vertices (a, c) , (b, c) , (b, d) and (a, d) , parameterize the boundary Γ and verify directly that

$$\int_{\Gamma} dz = \int_{\Gamma} z dz = 0.$$

8. Show that $\int_C z^k dz = 0$ for any integer $k \neq -1$ and $C : z = \operatorname{Re}^{i\theta}$, $0 \leq \theta \leq 2\pi$
- by showing that z^k is the derivative of a function analytic throughout C ,
 - directly, using the parametrization of C .
9. Evaluate $\int_C (z - i) dz$ where C is the parabolic segment:

$$z(t) = t + it^2, \quad -1 \leq t \leq 1$$

- by applying Proposition 4.12,
- by integrating along the straight line from $-1 + i$ to $1 + i$ and applying the Closed Curve Theorem.

10.* Evaluate

- $\int_0^i e^z dz$
- $\int_{\pi/2}^{\pi/2+i} \cos 2z dz$

11.* Suppose f is analytic in a convex region D and $|f'| \leq 1$ throughout D . Prove that f is a "contraction"; i.e., show that $|f(b) - f(a)| \leq |b - a|$ for all $a, b \in D$.

12.* Let a, b be two complex numbers in the left half-plane. Prove that $|e^a - e^b| < |a - b|$.

Chapter 5

Properties of Entire Functions

5.1 The Cauchy Integral Formula and Taylor Expansion for Entire Functions

We now show that if f is entire and if

$$g(z) = \begin{cases} \frac{f(z) - f(a)}{z - a} & z \neq a \\ f'(a) & z = a \end{cases}$$

then the Integral Theorem (4.15) and Closed Curve Theorem (4.16) apply to g as well as to f . (Note that since f is entire, g is continuous; however, it is not obvious that g is entire.) We begin by showing that the Rectangle Theorem applies to g .

5.1 Rectangle Theorem II

If f is entire and if

$$g(z) = \begin{cases} \frac{f(z) - f(a)}{z - a} & z \neq a \\ f'(a) & z = a \end{cases}$$

then $\int_{\Gamma} g(z)dz = 0$, where Γ is the boundary of a rectangle R .

Proof

We consider three cases.

I. $a \in \text{ext } R$.

In this case, g is analytic throughout R and the proof is exactly the same as that of Theorem 4.14. Note that the proof required only that the integrand be analytic throughout R and Γ .

II. $a \in \Gamma$.

Divide R into six subrectangles as indicated and note that because of the cancellations involved

$$\int_{\Gamma} g = \sum_{k=1}^6 \int_{\Gamma_k} g \quad (1)$$

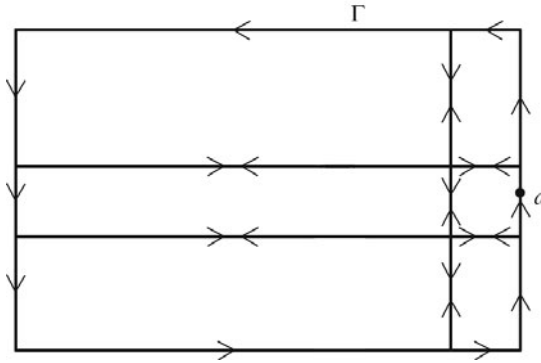

where Γ_k , $1 \leq k \leq 6$, denote the boundaries of the subrectangles. Since g is continuous in the compact domain \bar{R} , $g \ll M$ for some constant M . If we take the boundary of the rectangle containing a (call it Γ_1) to have length less than ϵ ,

$$\int_{\Gamma_1} g \ll M\epsilon \quad \text{by the } M\text{-}L \text{ formula}$$

while

$$\int_{\Gamma_k} g = 0, \quad k \neq 1$$

as in case (I). Hence by (1)

$$\int_{\Gamma} g \ll M\epsilon$$

for any $\epsilon > 0$ and the proof is complete.

III. $a \in \text{int } R$.

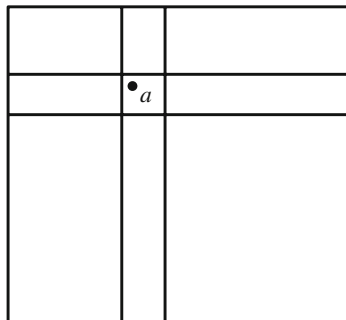

Here, as in the previous case, we subdivide R —this time into nine rectangles. Along the boundaries of the eight rectangles (not containing a)

$$\int_{\Gamma_k} g = 0,$$

while the integral along the boundary of the remaining subrectangle can be made arbitrarily small by choosing its length to be as small as required. As in the previous case, we conclude

$$\int_{\Gamma} g = \sum_{k=1}^9 \int_{\Gamma_k} g = 0. \quad \square$$

5.2 Corollary

Suppose g is as above. Then the Integral Theorem and the Closed Curve Theorem apply to g .

Proof

We observe that since g is continuous, the proofs of Theorems 4.15 and 4.16 apply, without any modification, to g . \square

5.3 Cauchy Integral Formula

Suppose that f is entire, that a is some complex number, and that C is the curve

$$C : Re^{i\theta}, \quad 0 \leq \theta \leq 2\pi, \quad \text{with } R > |a|.$$

Then

$$f(a) = \frac{1}{2\pi i} \int_C \frac{f(z)}{z-a} dz.$$

Proof

By Corollary 5.2

$$\int_C \frac{f(z) - f(a)}{z-a} dz = 0$$

so that

$$f(a) \int_C \frac{dz}{z-a} = \int_C \frac{f(z)}{z-a} dz$$

and the proof follows once we show that

$$\int_C \frac{dz}{z-a} = 2\pi i.$$

This lemma is proven below in somewhat greater generality. \square

5.4 Lemma

Suppose a is contained in the circle C_ρ : that is, C_ρ has center a , radius ρ , and $|a - \alpha| < \rho$. Then

$$\int_{C_\rho} \frac{dz}{z - a} = 2\pi i.$$

Proof

First we note that

$$\int_{C_\rho} \frac{dz}{z - \alpha} = \int_0^{2\pi} \frac{i\rho e^{i\theta}}{\rho e^{i\theta}} d\theta = 2\pi i,$$

while

$$\int_{C_\rho} \frac{dz}{(z - \alpha)^{k+1}} = 0 \quad \text{for } k = 1, 2, 3, \dots$$

The second equality follows not only from a direct evaluation of the integral

$$\int_{C_\rho} \frac{dz}{(z - \alpha)^{k+1}} = \frac{i}{\rho^k} \int_0^{2\pi} e^{-ik\theta} d\theta = 0$$

but also from the fact that $1/(z - \alpha)^{k+1}$ is equal to the derivative of the analytic function $-1/k(z - \alpha)^k$.

To evaluate $\int_{C_\rho} (1/(z - a))dz$, write

$$\begin{aligned} \frac{1}{z - a} &= \frac{1}{(z - \alpha) - (a - \alpha)} = \frac{1}{(z - \alpha)[1 - (a - \alpha)/(z - \alpha)]} \\ &= \frac{1}{(z - \alpha)} \cdot \frac{1}{1 - \omega} \end{aligned}$$

where

$$\omega = \frac{a - \alpha}{z - \alpha} \quad \text{has fixed modulus } \frac{|a - \alpha|}{\rho} < 1 \quad \text{throughout } C_\rho. \quad (1)$$

By (1) and the fact that $1/(1 - \omega) = 1 + \omega + \omega^2 + \dots$, we obtain

$$\begin{aligned} \frac{1}{z - a} &= \frac{1}{z - \alpha} \left[1 + \frac{a - \alpha}{z - \alpha} + \frac{(a - \alpha)^2}{(z - \alpha)^2} + \dots \right] \\ &= \frac{1}{z - \alpha} + \frac{a - \alpha}{(z - \alpha)^2} + \frac{(a - \alpha)^2}{(z - \alpha)^3} + \dots \end{aligned}$$

Since the convergence is uniform throughout C_ρ ,

$$\int_{C_\rho} \frac{1}{z - a} dz = \int_{C_\rho} \frac{1}{z - \alpha} dz + \sum_{k=1}^{\infty} \int_{C_\rho} \frac{(a - \alpha)^k}{(z - \alpha)^{k+1}} dz = 2\pi i. \quad \square$$

5.5 Taylor Expansion of an Entire Function

If f is entire, it has a power series representation. In fact, $f^{(k)}(0)$ exists for $k = 1, 2, 3, \dots$, and

$$f(z) = \sum_{k=0}^{\infty} \frac{f^{(k)}(0)}{k!} z^k$$

for all z .

Proof

Suppose $a \neq 0$, $R = |a| + 1$ and let C be the circle: $|\omega| = R$. By the Cauchy Integral Formula

$$f(z) = \frac{1}{2\pi i} \int_C \frac{f(\omega)}{\omega - z} d\omega$$

for all $z \ll a$.

As before, note that

$$\frac{1}{\omega - z} = \frac{1}{\omega \left(1 - \frac{z}{\omega}\right)} = \frac{1}{\omega} + \frac{z}{\omega^2} + \frac{z^2}{\omega^3} + \dots,$$

and since the convergence is uniform throughout C

$$\begin{aligned} f(z) &= \frac{1}{2\pi i} \int_C f(\omega) \left[\frac{1}{\omega} + \frac{z}{\omega^2} + \frac{z^2}{\omega^3} + \dots \right] d\omega \\ &= \frac{1}{2\pi i} \int_C \frac{f(\omega)}{\omega} d\omega + \left(\frac{1}{2\pi i} \int_C \frac{f(\omega)}{\omega^2} d\omega \right) z + \left(\frac{1}{2\pi i} \int_C \frac{f(\omega)}{\omega^3} d\omega \right) z^2 + \dots \\ &= \sum_{k=0}^{\infty} C_k z^k \end{aligned}$$

where

$$C_k = \frac{1}{2\pi i} \int_C \frac{f(\omega)}{\omega^{k+1}} d\omega. \quad (1)$$

Since for each z , there exists some $a \gg z$, the proof of the first part of the theorem appears to be complete. There is, however, one wrinkle. The contour C —and hence the coefficients of the power series—depended on a , for the radius R had to be chosen larger than $|a|$ to insure the uniform convergence of the power series for $1/(\omega - z)$. On the other hand, if we think of a as being fixed, we have shown that there exist coefficients $C_0(a)$, $C_1(a)$, $C_2(a)$, \dots , such that

$$f(z) = \sum C_k(a) z^k \quad (2)$$

for all $z \ll a$. To see that this is sufficient we note that although, a priori, the coefficients could change as we consider complex numbers a of increasing magnitude, they are in fact constant.

For, as we saw in Chapter 2 (Corollary 2.11), it follows from (2) that f is infinitely differentiable at 0 and that

$$C_k(a) = \frac{f^{(k)}(0)}{k!}.$$

Hence the coefficients are independent of a . Note, finally, that although the everywhere convergence of the series

$$\sum \frac{f^{(k)}(0)}{k!} z^k$$

is not proven explicitly, it is implicit in the fact that the series equals $f(z)$ for all z . \square

5.6 Corollary

An entire function is infinitely differentiable.

Proof

Since f has a power series expansion, we may invoke Corollary 2.10—an everywhere convergent power series is infinitely differentiable. \square

5.7 Corollary

If f is entire and if a is any complex number, then

$$f(z) = f(a) + f'(a)(z - a) + \frac{f''(a)}{2!}(z - a)^2 + \cdots \quad \text{for all } z.$$

Proof

Consider $g(\zeta) = f(\zeta + a)$ which is likewise entire. By 5.5

$$g(\zeta) = g(0) + g'(0)\zeta + \frac{g''(0)}{2!}\zeta^2 + \cdots,$$

so that

$$f(\zeta + a) = f(a) + f'(a)\zeta + \frac{f''(a)}{2!}\zeta^2 + \cdots.$$

Setting $\zeta = z - a$, the corollary follows. \square

5.8 Proposition

If f is entire and if

$$g(z) = \begin{cases} \frac{f(z) - f(a)}{z - a} & z \neq a \\ f'(a) & z = a \end{cases}$$

then g is entire.

Proof

By the previous corollary, for $z \neq a$

$$g(z) = f'(a) + \frac{f''(a)}{2!}(z-a) + \frac{f^{(3)}(a)}{3!}(z-a)^2 + \dots, \quad (1)$$

and by the definition of g , (1) is also valid at $z = a$. Since g is equal to an everywhere convergent power series, g is entire. \square

5.9 Corollary

Suppose f is entire with zeroes at a_1, a_2, \dots, a_N . Then if g is defined by

$$g(z) = \frac{f(z)}{(z-a_1)(z-a_2)\dots(z-a_N)} \quad \text{for } z \neq a_k,$$

$\lim_{z \rightarrow a_k} g(z)$ exists for $k = 1, 2, \dots, N$, and if $g(a_k)$ is defined by these limits, then g is entire.

Proof

Let $f_0(z) = f(z)$ and let

$$f_k(z) = \frac{f_{k-1}(z) - f_{k-1}(a_k)}{z - a_k} = \frac{f_{k-1}(z)}{z - a_k}, \quad z \neq a_k.$$

Assuming that f_{k-1} is entire, it follows from Proposition 5.8 that $f_k(z)$ has a limit as $z \rightarrow a_k$ and if we define $f_k(a_k)$ to be this limit, f_k is entire. Since f_0 is entire by hypothesis, the proof follows by induction. \square

5.2 Liouville Theorems and the Fundamental Theorem of Algebra; The Gauss-Lucas Theorem

5.10 Liouville's Theorem

A bounded entire function is constant.

Proof

Let a and b represent any two complex numbers and let C be any positively oriented circle centered at 0 and with radius $R > \max(|a|, |b|)$. Then according to the

Cauchy Integral Formula (5.3)

$$\begin{aligned}
 f(b) - f(a) &= \frac{1}{2\pi i} \int_C \frac{f(z)}{z-b} dz - \frac{1}{2\pi i} \int_C \frac{f(z)}{z-a} dz \\
 &= \frac{1}{2\pi i} \int_C \frac{f(z)(b-a)}{(z-a)(z-b)} dz \\
 &\ll \frac{M|b-a| \cdot R}{(R-|a|)(R-|b|)} \tag{1}
 \end{aligned}$$

using the usual estimate, where M represents the supposed upper bound for $|f|$. Since R may be taken as large as desired and since the expression in (1) approaches 0 as $R \rightarrow \infty$, $f(b) = f(a)$ and f is constant. \square

5.11 The Extended Liouville Theorem

If f is entire and if, for some integer $k \geq 0$, there exist positive constants A and B such that

$$|f(z)| \leq A + B|z|^k,$$

then f is a polynomial of degree at most k .

Proof

Note that the case $k = 0$ is the original Liouville Theorem. The general case follows by induction. Thus, we consider

$$g(z) = \begin{cases} \frac{f(z) - f(0)}{z} & z \neq 0 \\ f'(0) & z = 0. \end{cases}$$

By 5.8, g is entire and by the hypothesis on f ,

$$|g(z)| \leq C + D|z|^{k-1}.$$

Hence g is a polynomial of degree at most $k - 1$ and f is a polynomial of degree at most k . \square

5.12 Fundamental Theorem of Algebra

Every non-constant polynomial with complex coefficients has a zero in \mathbb{C} .

Proof

Let $P(z)$ be any polynomial. If $P(z) \neq 0$ for all $z \in \mathbb{C}$, $f(z) = 1/P(z)$ is an entire function. Furthermore if P is non-constant, $P \rightarrow \infty$ as $z \rightarrow \infty$ and f is bounded. But then, by Liouville's Theorem, f is constant, and so is P , contrary to our assumption. \square

Remarks

1. If α is a zero of an n -th degree polynomial P_n , $P_n(z) = (z - \alpha)P_{n-1}(z)$, where P_{n-1} is a polynomial of degree $n - 1$. This can be seen by the usual Euclidean Algorithm or by noting that

$$\left| \frac{P_n(z)}{z - \alpha} \right| \leq A + B|z|^{n-1}$$

and hence is equal to an $(n - 1)$ -st degree polynomial by the Extended Liouville Theorem.

2. α is called a zero of *multiplicity* k (or order k) if $P(z) = (z - \alpha)^k Q(z)$, where Q is a polynomial with $Q(\alpha) \neq 0$. Equivalently, α is a zero of multiplicity k if $P(\alpha) = P'(\alpha) = \dots = P^{(k-1)}(\alpha) = 0$, $P^{(k)}(\alpha) \neq 0$. The equivalence of the two definitions is easily established and is left as an exercise.
3. Although the Fundamental Theorem of Algebra only assures the existence of a single zero, an induction argument shows that an n -th degree polynomial has n zeroes (counting multiplicity). For, assuming every k -th degree polynomial can be written

$$P_k(z) = A(z - z_1) \cdots (z - z_k),$$

it follows that

$$P_{k+1}(z) = A(z - z_0)(z - z_1) \cdots (z - z_k).$$

By the above remark, any polynomial

$$P_n(z) = a_n z^n + a_{n-1} z^{n-1} + \cdots + a_0 \quad (2)$$

can also be expressed as

$$P_n(z) = a_n(z - z_1)(z - z_2) \cdots (z - z_n), \quad (3)$$

where z_1, z_2, \dots, z_n are the zeroes of P_n . A comparison of (2) and (3) yields the well-known relations between the zeroes of a polynomial and its coefficients. For example,

$$\sum z_k = -a_{n-1}/a_n. \quad (4)$$

There are many entire functions, such as $e^z - 1$, which have infinitely many zeroes, and whose derivatives are never zero. So there is no general analytic analogue of Rolle's Theorem. However, for polynomials, the Gauss-Lucas Theorem, below, offers a striking analogy and, in some ways a stronger form, of Rolle's Theorem.

Recall that a convex set is one that contains the entire line segment connecting any two of its points. Hence, if z_1 and z_2 belong to a convex set, so does every complex number of the form $tz_1 + (1 - t)z_2$, for $0 \leq t \leq 1$. We leave it as an exercise to show that if z_1, z_2, \dots, z_n belong to a convex set, so does every "convex" combination of the form

$$a_1 z_1 + a_2 z_2 + \cdots + a_n z_n; a_i \geq 0 \text{ for all } i, \text{ and } \sum a_i = 1. \quad (5)$$

5.13 Definition

The convex hull of a set S of complex numbers is the smallest convex set containing S .

5.14 Gauss-Lucas Theorem

The zeroes of the derivative of any polynomial lie within the convex hull of the zeroes of the polynomial.

Proof

Assume that the zeroes of P are z_1, z_2, \dots, z_n and that α is a zero of P' but not a zero of P , Then

$$\frac{P'(\alpha)}{P(\alpha)} = \frac{1}{\alpha - z_1} + \frac{1}{\alpha - z_2} + \dots + \frac{1}{\alpha - z_n} = 0 \quad (6)$$

Rewriting

$$\frac{1}{\alpha - z_i} = \frac{\bar{\alpha} - \bar{z}_i}{|\alpha - z_i|^2}$$

we can apply (6) to obtain

$$\bar{\alpha} = \sum a_i \bar{z}_i, \text{ with } a_i = \frac{1}{|\alpha - z_i|^2} \bigg/ \sum \frac{1}{|\alpha - z_i|^2}. \quad (7)$$

Finally, by taking conjugates in (7), we obtain an identical expression for α in terms of z_1, z_2, \dots, z_n . Hence α is in the convex hull of $\{z_1, z_2, \dots, z_n\}$. \square

A final remark

The Fundamental Theorem of Algebra can be considered a “nonexistence theorem” in the following sense. Recall that the complex numbers come into consideration when the reals are supplemented to include a solution of the equation $x^2 + 1 = 0$. One might have supposed that further extensions would arise as we sought zeroes of other polynomials with real or complex coefficients. By the Fundamental Theorem of Algebra, all such solutions are already contained in the field of complex numbers, and hence no such further extensions are possible. This is usually expressed by saying that the field of complex numbers is *algebraically closed*.

5.3 Newton’s Method and Its Application to Polynomial Equations

I. Introduction We saw in Chapter 1 that solutions of quadratic and cubic equations can be found in terms of square roots and cube roots of various expressions involving the coefficients. A similar formula is also available for fourth degree polynomial equations. On the other hand, one of the highlights of modern mathematics is

the famous theorem that no such solution, in terms of n -th roots, can be given for the general polynomial equation of degree five or higher. In spite of this, there are many graphing calculators that allow the user to input the coefficients of a polynomial of any degree and then almost immediately output all of its zeroes, correct to eight or nine decimal places. The explanation for this magic is that, although there are no formulas for solving all polynomial equations, there are many algorithms which can be used to find arbitrarily good approximations to the solutions.

One extremely popular and effective method for approximating solutions to equations of the form $f(z) = 0$, variations of which are incorporated in many calculators, is known as Newton's Method. It can be informally described as follows:

- i) Choose a point z_0 "sufficiently close" to a solution of the equation, which we will call s .
- ii) Define $z_1 = z_0 - f(z_0)/f'(z_0)$ and continue recursively, defining $z_{n+1} = z_n - f(z_n)/f'(z_n)$.

Then, if z_0 is sufficiently close to the root s , the sequence $\{z_n\}$ will converge to s . In fact, the convergence is usually extremely rapid.

If we are trying to approximate a real solution s to the "real" equation $f(x) = 0$, the algorithm has a very nice geometric interpretation. That is, suppose $(x_0, f(x_0))$ is a point P on the graph of the function $y = f(x)$. Then the tangent to the graph at point P is given by the equation $L(x) = f(x_0) + f'(x_0)(x - x_0)$. Hence $x_1 = x_0 - f(x_0)/f'(x_0)$ is precisely the point where the tangent line crosses the x -axis.

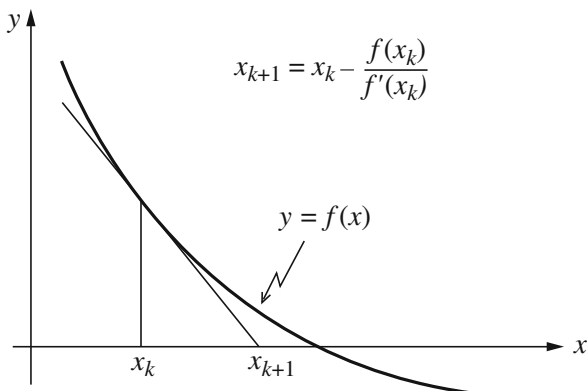

Similarly, x_{n+1} is the zero of the tangent to $y = f(x)$ at the point $(x_n, f(x_n))$. Thus, there is a very clear visual insight into the nature of the sequence generated by the algorithm and it is easy to convince oneself that the sequence converges to the solution s in most cases. However, the geometric argument leaves many questions unanswered. For example, how do we know if x_0 is sufficiently close to the root s ? Furthermore, if the sequence does converge, how quickly does it converge? Experimenting with simple examples will verify the assertion made earlier that the convergence is, in fact, very quick, but why is it? Finally, and of special interest to us,

why does the method work in the complex plane, where the geometric interpretation is no longer applicable? The answer to all these questions can be found by taking a slight detour into the topic of fixed-point iteration.

II. Fixed-Point Iteration Suppose we are given an equation in the form $z = g(z)$. Then a solution s is a “fixed-point” of the function g . As we will see below, under the proper conditions, approximating such a fixed point can often be accomplished by recursively defining $z_{n+1} = g(z_n)$, a process known as fixed point iteration.

5.15 Lemma

Let s denote a root of the equation $z = g(z)$, for some analytic function g . Suppose that z_0 belongs to a disc of the form $D(s; r)$ throughout which $|g'(z)| \leq K$, and let $z_1 = g(z_0)$. Then $|z_1 - s| \leq K|z_0 - s|$.

Proof

Note that $|z_1 - s| = |g(z_0) - g(s)|$. Using the complex version of the Fundamental Theorem of Calculus,

$$g(z_0) - g(s) = \int_s^{z_0} g'(z) dz$$

where we choose the path of integration to be the straight line from s to z_0 . The result then follows immediately from the $M - L$ formula. \square

5.16 Theorem

Let s denote a root of the equation $z = g(z)$, for some analytic function g . Suppose that z_0 belongs to a disc of the form $D(s; r)$ throughout which $|g'(z)| \leq K < 1$ and define the sequence $\{z_n\}$ recursively as: $z_{n+1} = g(z_n)$; $n = 0, 1, 2, \dots$. Then $\{z_n\} \rightarrow s$ as $n \rightarrow \infty$.

Proof

Note that, as in Lemma 5.15,

$$|z_{n+1} - s| \leq K|z_n - s|$$

and hence, by induction, $z_n \in D(s; r)$ for all n and $|z_n - s| \leq K^n|z_0 - s|$. Since $K < 1$, the result follows immediately. \square

5.17 Corollary

Let s denote a root of the equation $z = g(z)$, for some analytic function g and assume that $|g'(s)| < 1$. Then there exists a disc of the form $D(s; r)$ such that if $z_0 \in D(s; r)$

and if we define the sequence $\{z_n\}$ recursively as: $z_{n+1} = g(z_n)$; $n = 0, 1, 2, \dots$, $\{z_n\} \rightarrow s$ as $n \rightarrow \infty$.

Proof

Since $|g'(s)| < 1$, there exists a constant K with $|g'(s)| < K < 1$. But then, since g' is analytic, there must exist exist a disc $D(s; r)$ throughout which $|g'(z)| < K$. \square

Suppose we let $\varepsilon_n = |z_n - s|$ denote the n -th error, i.e. the absolute value of the difference between the n -th approximation z_n and the desired solution, s . Then the above results show that, with an appropriate starting value z_0 , the sequence of errors satisfies the inequality

$$\varepsilon_{n+1} \leq K \varepsilon_n \quad (1)$$

If, e.g. $K = \frac{1}{2}$, the error will be reduced by a factor of $\frac{1}{10}$ for every 3 or 4 iterations. An iteration scheme which satisfies inequality (1) for any value of K , $0 < K < 1$, is said to converge linearly. In that case, the number of iterations required to obtain n decimal place accuracy is roughly proportional to n .

Corollary 5.17 shows that an important condition for the convergence of fixed-point iteration is that $|g'(s)| < 1$. This raises the following practical problem. An equation in the familiar form $f(z) = 0$ can certainly be rewritten as an equivalent equation in the fixed point form $z = g(z)$. For example, one could simply add the monomial z to both sides of the equation. But how can we rewrite $f(z) = 0$ in the form $z = g(z)$ with the additional condition that $|g'(s)| < 1$ at the *unknown* solution s ? One answer to this problem will provide the insight to Newton's method that we are looking for. That is, suppose the equation $f(z) = 0$ is rewritten in the form $z = g(z) = z - f(z)/f'(z)$. Then the fixed point iteration algorithm is precisely Newton's Method. Moreover, we can find the exact value of $g'(s)$!!

5.18 Lemma

If f is analytic and has a zero of order k at $z = s$, and if $g(z) = z - f(z)/f'(z)$, then g is also analytic at s and $g'(s) = 1 - \frac{1}{k}$.

Proof

By hypothesis, $f(z) = (z - s)^k h(z)$, with $h(s) \neq 0$. Hence

$$f(z)/f'(z) = \frac{(z - s)h(z)}{kh(z) + (z - s)h'(z)}$$

Thus f/f' is analytic at s (with the appropriate value of 0 at s), and its power series expansion about the point s is of the form $\frac{1}{k}(z - s) + a_2(z - s)^2 + \dots$. Hence $g'(s) = 1 - \frac{1}{k}$ \square

Applying Corollary 5.17 then yields

5.19 Theorem

Let s denote a root of the equation $f(z) = 0$. Let $g(z) = z - f(z)/f'(z)$, and define the sequence $\{z_n\}$ recursively as: $z_{n+1} = g(z_n)$; $n = 0, 1, 2, \dots$. Then there exists a disc of the form $D(s; r)$ such that $z_0 \in D(s; r)$ guarantees that $\{z_n\} \rightarrow s$ as $n \rightarrow \infty$. \square

If $f(z)$ has a simple zero at s , according to Lemma 5.18, $g(z) = z - f(z)/f'(z)$ will have $g'(s) = 0$. In this case, the iteration scheme will converge especially rapidly.

5.20 Lemma

Let s denote a root of the equation $z = g(z)$, for some analytic function g such that $g'(s) = 0$. Suppose that z_0 belongs to a disc of the form $D(s; r)$ throughout which

$$|g''(z)| \leq M$$

and let $z_1 = g(z_0)$. Then $|z_1 - s| \leq \frac{1}{2}M|z_0 - s|^2$.

Proof

As in lemma 5.15, we begin by noting that $z_1 - s = g(z_0) - g(s) = \int_s^{z_0} g'(z) dz$. But for any value of z on the line segment $[s, z_0]$, we can write:

$$|g'(z)| = |g'(z) - g'(s)| = \left| \int_s^z g''(z) dz \right| \leq M|z - s| \quad (2)$$

Let $\Delta z = (z_0 - s)/n$ and write

$$\int_s^{z_0} g'(z) dz = \int_s^{s+\Delta z} g'(z) dz + \int_{s+\Delta z}^{s+2\Delta z} g'(z) dz + \dots + \int_{z_0-\Delta z}^{z_0} g'(z) dz \quad (3)$$

Then applying the M - L formula to each of the integrals in (3) and using the estimates for g' given by (2) show that $\int_s^{z_0} g'(z) dz$ is bounded by

$$\sum_{k=1}^n M k (\Delta z)^2 = M \frac{n(n+1)}{2} \frac{|z_0 - s|^2}{n^2}$$

and the lemma follows by letting $n \rightarrow \infty$. \square

5.21 Definition

If $\varepsilon_n = |z_n - s|$ satisfies $\varepsilon_{n+1} \leq K \varepsilon_n^2$, we say that the sequence $\{z_n\}$ converges quadratically to s .

Note that in the case of quadratic convergence, once the sequence of iterations is close to its limit, each iteration virtually doubles the number of decimal places which are accurate. If, for example, at some point the error is in the 10th decimal

place, then at that point, ε_n is approximately 10^{-10} , so that $\varepsilon_{n+1} = K\varepsilon_n^2$ will be approximately 10^{-20} .

Lemmas 5.18 and 5.20 combine then to give us

5.22 Theorem

If $f(z)$ has a simple zero at a point s , and if z_0 is sufficiently close to s , Newton's Method will produce a sequence which converges quadratically to s . \square

III. Newton's Method Applied to Polynomial Equations While Newton's Method can be (and is) applied to all sorts of equations, it works especially well for polynomial equations. For one thing, we don't have to worry about the existence of solutions; they are guaranteed by the Fundamental Theorem of Algebra. That may be one reason why Newton himself applied his method only to polynomial equations. According to Theorems 5.19 and 5.22, as long as the initial approximation z_0 is sufficiently close to one of the roots, Newton's Method will converge to it. If we are looking for a simple zero of a polynomial, the method will actually converge quadratically. Of course, there are starting points which will not yield a convergent sequence. For example, if z_0 is a zero of the derivative of the polynomial, z_1 will not be defined! On the other hand, the set of "successful" starting points is surprisingly robust.

Modern technology has been applied to identifying what have been labeled "Newton basins", the distinct regions in the complex plane from which a starting value will yield a sequence converging to the distinct zeroes of a polynomial. If these regions are shaded in different colors, they yield remarkably interesting sketches. Aside from the example below, interested readers can generate their own sketches of the Newton basins for various polynomials at <http://aleph0.clarku.edu/~djoyce/newton/technical.html>

The sketch below shows the Newton basins for the eight zeroes of the polynomial $P(z) = (z^4 - 1)(z^4 + 4)$. The eight roots: $\pm 1, \pm i, \pm(1 + i), \pm(1 - i)$ are at the corners and the midpoints of the sides of the displayed square. The black regions contain the starting points which do not yield a convergent sequence.

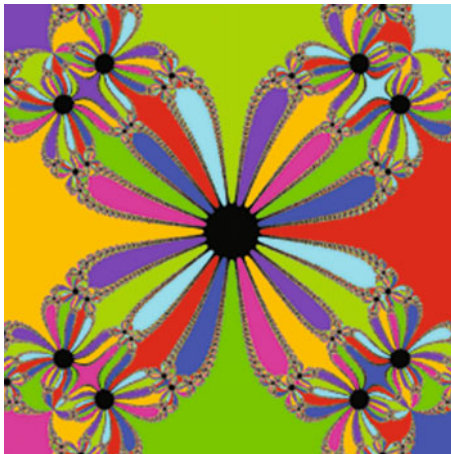

Exercises

- Find the power series expansion of $f(z) = z^2$ around $z = 2$.
- Find the power series expansion for e^z about any point a .
- f is called an *odd* function if $f(z) = -f(-z)$ for all z ; f is called *even* if $f(z) = f(-z)$.
 - Show that an odd entire function has only odd terms in its power series expansion about $z = 0$.
[Hint: show f odd $\Rightarrow f'$ even, etc., or use the identity

$$f(z) = \frac{f(z) - f(-z)}{2}.$$

- Prove an analogous result for even functions.
- By comparing the different expressions for the power series expansion of an entire function f , prove that

$$f^{(k)}(0) = \frac{k!}{2\pi i} \int_C \frac{f(\omega)}{\omega^{k+1}} d\omega, \quad k = 0, 1, 2, \dots$$

for any circle C surrounding the origin.

- (A Generalization of the Cauchy Integral Formula). Show that

$$f^{(k)}(a) = \frac{k!}{2\pi i} \int_C \frac{f(\omega)}{(\omega - a)^{k+1}} d\omega, \quad k = 1, 2, \dots$$

where C surrounds the point a and f is entire.

- Suppose an entire function f is bounded by M along $|z| = R$. Show that the coefficients C_k in its power series expansion about 0 satisfy

$$|C_k| \leq \frac{M}{R^k}.$$

- Suppose a polynomial is bounded by 1 in the unit disc. Show that all its coefficients are bounded by 1.
- (An alternate proof of Liouville's Theorem). Suppose that $|f(z)| \leq A + B|z|^k$ and that f is entire. Show then that all the coefficients C_j , $j > k$, in its power series expansion are 0. (See Exercise 6a.)
 - Suppose f is entire and $|f(z)| \leq A + B|z|^{3/2}$. Show that f is a linear polynomial.
 - Suppose f is entire and $|f'(z)| \leq |z|$ for all z . Show that $f(z) = a + bz^2$ with $|b| \leq \frac{1}{2}$.
 - Prove that a nonconstant entire function cannot satisfy the two equations
 - $f(z+1) = f(z)$
 - $f(z+i) = f(z)$

for all z . [Hint: Show that a function satisfying both equalities would be bounded.]

- A *real polynomial* is a polynomial whose coefficients are all real. Prove that a real polynomial of odd degree must have a real zero. (See Exercise 5 of Chapter 1.)
- Show that every real polynomial is equal to a product of real linear and quadratic polynomials.
- Suppose P is a polynomial such that $P(z)$ is real if and only if z is real. Prove that P is linear. [Hint: Set $P = u + iv$, $z = x + iy$ and note that $v = 0$ if and only if $y = 0$.
Conclude that:
 - either $v_y \geq 0$ throughout the real axis or $v_y \leq 0$ throughout the real axis;
 - either $u_x \geq 0$ or $u_x \leq 0$ for all real values and hence u is monotonic along the real-axis;
 - $P(z) = \alpha$ has only one solution for real-valued α .]

14. Show that α is a zero of multiplicity k if and only if

$$P(\alpha) = P'(\alpha) = \cdots = P^{(k-1)}(\alpha) = 0,$$

$$\text{and } P^{(k)}(\alpha) \neq 0.$$

15. Suppose that f is entire and that for each z , either $|f(z)| \leq 1$ or $|f'(z)| \leq 1$. Prove that f is a linear polynomial. [Hint: Use a line integral to show

$$|f(z)| \leq A + |z| \quad \text{where } A = \max(1, |f(0)|).]$$

- 16.* Let $(z_1 + z_2 + \cdots + z_n)/n$ denote the *centroid* of the complex numbers z_1, z_2, \dots, z_n . Use formula (4) in section 5.2 to show that the centroid of the zeroes of a polynomial is the same as the centroid of the zeroes of its derivative.

- 17.* Use induction to show that if z_1, z_2, \dots, z_n belong to a convex set, so does every "convex" combination of the form

$$a_1 z_1 + a_2 z_2 + \cdots + a_n z_n; \quad a_i \geq 0 \text{ for all } i, \text{ and } \sum a_i = 1.$$

- 18.* Let $P_k(z) = 1 + z + z^2/2! + \cdots + z^k/k!$, the k th partial sum of e^z .

- Show that, for all values of $k \geq 1$, the centroid of the zeroes of P_k is -1 .
- Let z_k be a zero of P_k with maximal possible absolute value. Prove that $\{|z_k|\}$ is an increasing sequence.

- 19.* Let $P(z) = 1 + 2z + 3z^2 + \cdots + nz^{n-1}$. Use the Gauss-Lucas theorem to show that all the zeroes of $P(z)$ are inside the unit disc. (See exercise 20 of Chapter 1 for a more direct proof.)

- 20.* Find estimates for \sqrt{i} by applying Newton's method to the polynomial equation $z^2 = i$, with $z_0 = 1$.

Chapter 6

Properties of Analytic Functions

Introduction

In the last two chapters, we studied the connection between everywhere convergent power series and entire functions. We now turn our attention to the more general relationship between power series and analytic functions. According to Theorem 2.9 every power series represents an analytic function inside its circle of convergence. Our first goal is the converse of this theorem: we will show that a function analytic in a disc can be represented there by a power series. We then turn to the question of analytic functions in arbitrary open sets and the local behavior of such functions.

6.1 The Power Series Representation for Functions Analytic in a Disc

6.1 Theorem

Suppose f is analytic in $D = D(a; r)$. If the closed rectangle R and the point a are both contained in D and Γ represents the boundary of R ,

$$\int_{\Gamma} f(z)dz = \int_{\Gamma} \frac{f(z) - f(a)}{z - a} dz = 0.$$

Proof

The proof is exactly the same as those of Theorems 4.14 and 5.1. The only requirement there was that f be analytic throughout R , and this is satisfied since $R \subset D$. \square

To simplify notation, we adopt the following convention. If $f(z)$ is analytic in a region D , including the point a , the function

$$g(z) = \frac{f(z) - f(a)}{z - a}$$

will denote the function given by

$$g(z) = \begin{cases} \frac{f(z) - f(a)}{z - a} & z \in D, \quad z \neq a \\ f'(a) & z = a. \end{cases}$$

The fact that g is analytic at a is proven in Proposition 6.7. (Compare with Proposition 5.8.)

6.2 Theorem

If f is analytic in $D(a; r)$, and $a \in D(a; r)$, there exist functions F and G , analytic in D and such that

$$F'(z) = f(z), \quad G'(z) = \frac{f(z) - f(a)}{z - a}.$$

Proof

We define

$$F(z) = \int_a^z f(\zeta) d\zeta$$

and

$$G(z) = \int_a^z \frac{f(\zeta) - f(a)}{\zeta - a} d\zeta$$

where the path of integration consists of the horizontal and then vertical segments from a to z . Note that for any $z \in D(a; r)$ and h small enough, $z + h \in D(a; r)$ so that, as in 4.15, we may apply the Rectangle Theorem to the respective difference quotients to conclude

$$F'(z) = f(z)$$

and

$$G'(z) = \frac{f(z) - f(a)}{z - a}. \quad \square$$

6.3 Theorem

If f and a are as above and C is any (smooth) closed curve contained in $D(a; r)$,

$$\int_C f(z) dz = \int_C \frac{f(z) - f(a)}{z - a} dz = 0.$$

Proof

According to Theorem 6.2, there exists G , analytic in $D(a; r)$ and such that

$$G'(z) = \frac{f(z) - f(a)}{z - a}.$$

Hence,

$$\int_C \frac{f(z) - f(a)}{z - a} dz = \int_C G'(z) dz = G(z(b)) - G(z(a)) = 0$$

since the initial and terminal points $z(a)$ and $z(b)$ coincide. Similarly, $\int_C f(z) dz = 0$. \square

6.4 Cauchy Integral Formula

Suppose f is analytic in $D(\alpha; r)$, $0 < \rho < r$, and $|a - \alpha| < \rho$. Then

$$f(a) = \frac{1}{2\pi i} \int_{C_\rho} \frac{f(z)}{z - a} dz$$

where C_ρ represents the circle $\alpha + \rho e^{i\theta}$, $0 \leq \theta \leq 2\pi$.

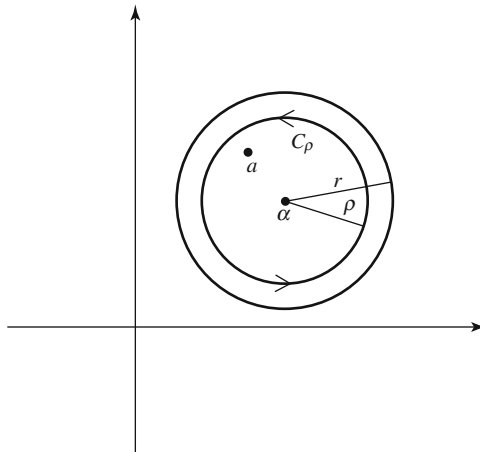

Proof

$$\int_{C_\rho} \frac{f(z) - f(a)}{z - a} dz = 0$$

so that

$$f(a) \int_{C_\rho} \frac{dz}{z - a} = \int_{C_\rho} \frac{f(z)}{z - a} dz.$$

Moreover, according to Lemma 5.4,

$$\int_{C_\rho} \frac{dz}{z - a} = 2\pi i$$

and the proof is complete. \square

6.5 Power Series Representation for Functions Analytic in a Disc

If f is analytic in $D(\alpha; r)$ there exist constants C_k such that

$$f(z) = \sum_{k=0}^{\infty} C_k (z - \alpha)^k$$

for all $z \in D(\alpha; r)$.

Proof

Pick $a \in D(\alpha; r)$ and $\rho > 0$ such that $|a - \alpha| < \rho < r$.

By the previous integral formula, if $|z - \alpha| < |a - \alpha|$

$$f(z) = \frac{1}{2\pi i} \int_{C_\rho} \frac{f(\omega)}{\omega - z} d\omega$$

and using the fact that

$$\frac{1}{\omega - \alpha} + \frac{z - \alpha}{(\omega - \alpha)^2} + \frac{(z - \alpha)^2}{(\omega - \alpha)^3} + \dots$$

converges uniformly to $1/(\omega - z)$ throughout C_ρ (see Lemma 5.4)

$$\begin{aligned} f(z) &= \frac{1}{2\pi i} \int_{C_\rho} f(\omega) \left[\frac{1}{\omega - \alpha} + \frac{z - \alpha}{(\omega - \alpha)^2} + \frac{(z - \alpha)^2}{(\omega - \alpha)^3} + \dots \right] d\omega \\ &= C_0(\rho) + C_1(\rho)(z - \alpha) + C_2(\rho)(z - \alpha)^2 + \dots \end{aligned} \quad (1)$$

where

$$C_k(\rho) = \frac{1}{2\pi i} \int_{C_\rho} \frac{f(\omega)}{(\omega - \alpha)^{k+1}} d\omega.$$

Note, then, that the coefficients $C_k(\rho)$ are actually independent of ρ . For once again, as in 5.5, we can apply (1) to conclude that f is infinitely differentiable at α and

$$C_k(\rho) = \frac{f^{(k)}(\alpha)}{k!} \text{ for each } \rho, 0 < \rho < r, \text{ and all } k.$$

Hence, for all $z \in D(\alpha; r)$

$$f(z) = \sum_{k=0}^{\infty} C_k (z - \alpha)^k$$

with

$$C_k = \frac{f^{(k)}(\alpha)}{k!} = \frac{1}{2\pi i} \int_{C_\rho} \frac{f(z)}{(z - \alpha)^{k+1}} dz. \quad \square$$

6.2 Analytic in an Arbitrary Open Set

The methods used above cannot be generalized to find a single power series equal to a given analytic function in an arbitrary open set. In fact no such generalization is possible even to the most elementary of domains—e.g., a square. The breakdown in the previous strategy arises when, given a point a in the square, we try to find a contour C surrounding a and the center α of the square such that

$$\left| \frac{a - \alpha}{\omega - \alpha} \right| < 1 \quad \text{for all } \omega \in C$$

(see the diagram). As we shall soon see, this is not simply a technical difficulty but a reflection of the fact that in general, no such power series exists! However, we can apply our previous results to obtain the following general theorem.

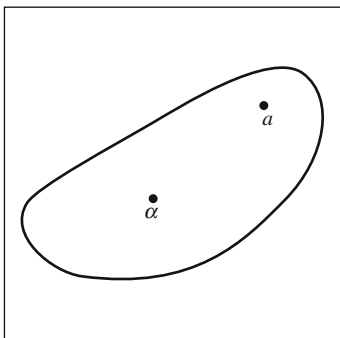

6.6 Theorem

If f is analytic in an arbitrary open domain D , then for each $\alpha \in D$, there exist constants C_k such that

$$f(z) = \sum_{k=0}^{\infty} C_k (z - \alpha)^k$$

for all points z inside the largest disc centered at α and contained in D .

Proof

This is a simple reformulation of Theorem 6.5. □

EXAMPLES

- i. $f(z) = 1/(z - 1)$ is analytic at $z = 2$ and in a disc of radius 1 centered at $z = 2$. To find a power series representation for f in that disc, we write

$$\frac{1}{z - 1} = \frac{1}{1 + (z - 2)} = 1 - (z - 2) + (z - 2)^2 - (z - 2)^3 + \dots \quad (1)$$

which converges as long as $|z - 2| < 1$.

Note that the power series diverges throughout $|z - 2| > 1$ despite the fact that $f(z) = 1/(z - 1)$ is analytic everywhere except at the single point $z = 1$.

Furthermore, according to Theorem 2.14 any other power series $\sum a_k(z - 2)^k$ which equals $1/(z - 1)$ in *any* disc around $z = 2$ would have to be identical with the power series in (1). Hence, there is *no* power series $\sum a_k(z - 2)^k$ equal to $1/(z - 1)$ throughout its domain of analyticity.

ii. To find a power series representation for $1/z^2$ near $z = 3$, we set

$$\begin{aligned} \frac{1}{z^2} &= \left[\frac{1}{3 + (z - 3)} \right]^2 = \frac{1}{9} \left[\frac{1}{1 + (z - 3)/3} \right]^2 \\ &= \frac{1}{9} \left[1 - \frac{(z - 3)}{3} + \frac{(z - 3)^2}{9} - \frac{(z - 3)^3}{27} + \dots \right]^2 \\ &= \frac{1}{9} \left[1 - \frac{2(z - 3)}{3} + \frac{3(z - 3)^2}{9} - \frac{4(z - 3)^3}{27} + \dots \right] \\ &= \sum_{k=0}^{\infty} \frac{(-1)^k (k + 1)}{9 \cdot 3^k} (z - 3)^k. \end{aligned}$$

Note again that the radius of convergence

$$1/\limsup |C_k|^{1/k} = \lim \left(\frac{9 \cdot 3^k}{k + 1} \right)^{1/k} = 3$$

represents the radius of the largest disc centered at $z = 3$ in which $1/z^2$ is analytic.

iii. To find the first three terms of the power series for $f(z) = \sin(1/z)$ around $z = 1$, because no immediate formula suggests itself, we evaluate the coefficients directly using the formula

$$C_k = \frac{f^{(k)}(1)}{k!}.$$

Thus we find

$$f(z) = \sin \frac{1}{z} = \sin 1 - \cos 1(z - 1) + \frac{(2 \cos 1 - \sin 1)}{2}(z - 1)^2 + \dots \quad \diamond$$

6.3 The Uniqueness, Mean-Value, and Maximum-Modulus Theorems; Critical Points and Saddle Points

We now consider some of the implications of the power series representations discussed in Theorem 6.6. We begin with a local version of Proposition 5.8.

6.7 Proposition

If f is analytic at α , so is

$$g(z) = \begin{cases} \frac{f(z) - f(\alpha)}{z - \alpha} & z \neq \alpha \\ f'(\alpha) & z = \alpha. \end{cases}$$

Proof

By Theorem 6.6, in some neighborhood of α ,

$$f(z) = f(\alpha) + f'(\alpha)(z - \alpha) + \frac{f''(\alpha)}{2!}(z - \alpha)^2 + \dots$$

Thus g has the power series representation

$$g(z) = f'(\alpha) + \frac{f''(\alpha)}{2!}(z - \alpha) + \frac{f^{(3)}(\alpha)}{3!}(z - \alpha)^2 + \dots$$

in the same neighborhood, and by 2.9, g is analytic at α . □

6.8 Theorem

If f is analytic at z , then f is infinitely differentiable at z .

Proof

We need only recall that, by definition, f is analytic at a point z if it is analytic in an open set containing z . By 6.6, then, in some disc containing z , f may be expressed as a power series. This completes the proof, since power series are infinitely differentiable (Corollary 2.10). □

6.9 Uniqueness Theorem

Suppose that f is analytic in a region D and that $f(z_n) = 0$ where $\{z_n\}$ is a sequence of distinct points and $z_n \rightarrow z_0 \in D$. Then $f \equiv 0$ in D .

Proof

Since f has a power series representation around z_0 , by the Uniqueness Theorem for Power Series, $f = 0$ throughout some disc containing z_0 . To show that $f \equiv 0$ in the whole domain D , we split D into two sets:

$$\begin{aligned} A &= \{z \in D: z \text{ is a limit of zeroes of } f\}, \\ B &= \{z \in D: z \notin A\}. \end{aligned}$$

By definition, $A \cap B = \emptyset$. A is open by the Uniqueness Theorem for power series: if z is a limit of zeroes of f , $f \equiv 0$ in an entire disc around z and that disc is

contained in A . B is open since for each $z \in B$, there must be some $\delta > 0$ such that $f(\omega) \neq 0$ for $0 < |z - \omega| < \delta$. The disc $D(z; \delta)$ would then be contained in B . By the connectedness of D , then, either A or B must be empty. But, by hypothesis, $z_0 \in A$. Thus B is empty and every $z \in D$ is a limit of zeroes of f . By the continuity of f , then, $f \equiv 0$ in D . \square

6.10 Corollary

If two functions f and g , analytic in a region D , agree at a set of points with an accumulation point in D , then $f \equiv g$ through D .

Proof

Consider $f - g$. \square

Note that a non-trivial analytic function may have infinitely many zeroes. For example, $\sin z$, which is entire, is equal to 0 at all the points $z = n\pi$, $n = 0, \pm 1, \pm 2, \dots$. In fact, $\sin(1/z) = 0$ on the set

$$\left\{ \frac{1}{n\pi} : n = \pm 1, \pm 2, \dots \right\}$$

which has an accumulation point at 0! Because this limit point is not in the domain of analyticity of $\sin(1/z)$, however, $\sin(1/z)$ does not satisfy the hypothesis of Theorem 6.9.

6.11 Theorem

If f is entire and if $f(z) \rightarrow \infty$ as $z \rightarrow \infty$, then f is a polynomial.

Proof

By hypothesis, there is some $M > 0$ such that $|z| > M$ implies that $|f(z)| > 1$. We conclude that f has at most a finite number of zeroes $\alpha_1, \alpha_2, \dots, \alpha_N$. Otherwise, the set of zeroes would have an accumulation point in $D(0; M)$, and by the Uniqueness Theorem f would be identically zero, contradicting the original hypothesis. If we divide out the zeroes of f ,

$$g(z) = \frac{f(z)}{(z - \alpha_1)(z - \alpha_2) \cdots (z - \alpha_N)}$$

is likewise entire (Corollary 5.9), and never equal to zero; hence

$$h(z) = \frac{1}{g(z)} = (z - \alpha_1)(z - \alpha_2) \cdots (z - \alpha_N)/f(z)$$

is also entire. Since $f \rightarrow \infty$ as $z \rightarrow \infty$, $|h(z)| \leq A + |z|^N$; therefore, by Theorem 5.11, h is a polynomial. But $h = 1/g \neq 0$, hence according to the

Fundamental Theorem of Algebra, h is a constant k . Thus

$$f(z) = \frac{1}{k}(z - \alpha_1)(z - \alpha_2) \cdots (z - \alpha_N). \quad \square$$

The Uniqueness Theorem is often used to demonstrate the validity in the complex plane of functional equations known to be true on the real line. For example, to prove the identity

$$e^{z_1+z_2} = e^{z_1}e^{z_2} \quad (2)$$

we first take z_2 to be a fixed real number. Then $e^{z_1+z_2}$ and $e^{z_1} \cdot e^{z_2}$ represent two entire functions of z_1 which agree at all real points and hence by the Uniqueness Theorem, they agree for all complex z_1 as well. Finally, for any fixed z_1 , we consider the two sides of (2) as analytic functions in z_2 which agree for real z_2 , and again applying the Uniqueness Theorem, we conclude that they agree for all complex z_2 as well. Hence (2) is valid for all complex z_1 and z_2 . Similarly, equations such as

$$\tan^2 z = \sec^2 z - 1,$$

which are known to be true for real z , are valid throughout their domains of analyticity.

In general, if there is an “analytic” relationship among analytic functions: that is, a functional equation of the form

$$F(f, g, h, \dots) = 0$$

which is satisfied by the analytic function $F(f, g, h, \dots)$ on a set with an accumulation point in its region of analyticity, then the equation holds throughout the region.

We now examine the local behavior of analytic functions.

6.12 Mean Value Theorem

If f is analytic in D and $\alpha \in D$, then $f(\alpha)$ is equal to the mean value of f taken around the boundary of any disc centered at α and contained in D . That is,

$$f(\alpha) = \frac{1}{2\pi} \int_0^{2\pi} f(\alpha + re^{i\theta}) d\theta$$

when $D(\alpha; r) \subset D$.

Proof

This is a reformulation of the Cauchy Integral Formula (6.4) with $a = \alpha$. That is,

$$f(\alpha) = \frac{1}{2\pi i} \int_{C_r} \frac{f(z)}{z - \alpha} dz,$$

and introducing the parameterization $z = \alpha + re^{i\theta}$, we see that

$$f(\alpha) = \frac{1}{2\pi} \int_0^{2\pi} f(\alpha + re^{i\theta}) d\theta. \quad \square$$

In analogy with the real case, we will call a point z a *relative maximum* of f if $|f(z)| \geq |f(\omega)|$ for all complex ω in some neighborhood of z . A relative minimum is defined similarly.

6.13 Maximum-Modulus Theorem

A non-constant analytic function in a region D does not have any interior maximum points: For each $z \in D$ and $\delta > 0$, there exists some $\omega \in D(z; \delta) \cap D$, such that $|f(\omega)| > |f(z)|$.

Proof

The fact that

$$|f(\omega)| \geq |f(z)|$$

for some ω near z follows immediately from the Mean-Value Theorem. Since for $r > 0$ such that $D(z; r) \subset D$ we have

$$f(z) = \frac{1}{2\pi} \int_0^{2\pi} f(z + re^{i\theta}) d\theta,$$

it follows that

$$|f(z)| \leq \frac{1}{2\pi} \int_0^{2\pi} |f(z + re^{i\theta})| d\theta \leq \max_{\theta} |f(z + re^{i\theta})|. \quad (3)$$

Similarly, we may deduce that $|f(\omega)| > |f(z)|$ for some $\omega \in D(z; r)$. For, to obtain equality in (3), $|f|$ would have to be constant throughout the circle $C(z; r)$ and since this holds for all sufficiently small $r > 0$, $|f|$ would be constant throughout a disc. But then by Theorem 3.7, f would be constant in that disc, and by the Uniqueness Theorem, f would be constant throughout D . \square

Ironically, the Maximum-Modulus Theorem actually asserts that an analytic function has no relative maximum. It is sometimes given a more positive flavor as follows.

Suppose a function f is analytic in a bounded region D and continuous on \bar{D} . (We will, henceforth, use the expression “ f is C-analytic in D ” to denote this hypothesis.) Somewhere in the compact domain \bar{D} , the continuous function $|f|$ must assume its maximum value. The Maximum-Modulus Theorem may then be invoked to assert that this maximum is always assumed on the boundary of the domain.

6.14 Minimum Modulus Theorem

If f is a non-constant analytic function in a region D , then no point $z \in D$ can be a relative minimum of f unless $f(z) = 0$.

Proof

Suppose that $f(z) \neq 0$ and consider $g = 1/f$. If z were a minimum point for f , it would be a maximum point for g . Hence g would be constant in D , contrary to our hypothesis on f . \square

Remark

We can also prove the Maximum-Modulus Theorem by analyzing the local power series representation for an analytic function. That is, for any point α , consider the power series

$$f(z) = C_0 + C_1(z - \alpha) + C_2(z - \alpha)^2 + \cdots,$$

which is convergent in some disc around α . To find z near α and such that $|f(z)| > |f(\alpha)|$, we first assume $C_1 \neq 0$ and set $z = \alpha + \delta e^{i\theta}$, with $\delta > 0$ “small”, and θ chosen so that C_0 and $C_1\delta e^{i\theta}$ have the same argument. Then

$$|f(\alpha)| = |C_0|$$

$$\begin{aligned} |f(z)| &\geq |C_0 + C_1(z - \alpha)| - |C_2(z - \alpha)^2 + C_3(z - \alpha)^3 + \cdots| \\ &\geq |C_0| + |C_1\delta| - \delta^2|C_2 + C_3(z - \alpha) + \cdots|. \end{aligned}$$

Since the last expression represents a convergent series,

$$|f(z)| \geq |C_0| + |C_1\delta| - A\delta^2 \geq |C_0| + \frac{1}{2}|C_1\delta| > |f(\alpha)|$$

as long as $\delta < |C_1|/2A$. Hence α cannot be a maximum point. Note that if $C_1 = 0$, the same argument can be applied by focusing on the first non-zero coefficient C_k .

This technique of studying the local behavior of an analytic function by considering the first terms of its power series expansion can be used to derive the following result.

Recall that in calculus, relative maximum points were found among the critical points (those points at which $f' = 0$) of a differentiable function f . The proposition below shows a somewhat surprising contrast in the behavior of an analytic function at a point where it assumes its maximum modulus.

6.15 Theorem

Suppose f is nonconstant and analytic on the closed disc D , and assumes its maximum modulus at the boundary point z_0 . Then $f'(z_0) \neq 0$.

Proof (G. Pólya and G. Szegő)

Assume that $f'(z_0) = 0$. For any complex number ζ of sufficiently small modulus we have

$$f(z_0 + \zeta) = f(z_0) + \frac{f^{(k)}(z_0)}{k!} \zeta^k + \dots,$$

where k is the least integer with $f^{(k)}(z_0) \neq 0$ and the omitted terms are all of higher order in ζ than ζ^k . Multiplying the above expression by its conjugate shows

$$\begin{aligned} |f(z_0 + \zeta)|^2 &= f(z_0 + \zeta) \overline{f(z_0 + \zeta)} \\ &= |f(z_0)|^2 + \frac{2}{k!} \operatorname{Re} \left(\overline{f(z_0)} f^{(k)}(z_0) \zeta^k \right) + \dots. \end{aligned}$$

Since $|f(z_0)| = \max_{z \in D} |f(z)|$, $f(z_0) \neq 0$. Write $\overline{f(z_0)} f^{(k)}(z_0) = A e^{i\alpha}$ with $A > 0$, and let $e^{i\theta} = \zeta/|\zeta|$. Then

$$|f(z_0 + \zeta)|^2 = |f(z_0)|^2 + \frac{2A}{k!} |\zeta|^k \cos(k\theta + \alpha) + \dots,$$

and, for ζ of sufficiently small modulus, $|f(z_0 + \zeta)| - |f(z_0)|$ has the same sign as $\cos(k\theta + \alpha)$. It follows that

$|f(z)| > |f(z_0)|$ if z is in any of the k wedges of the form

$$\left\{ z_0 + r_\theta e^{i\theta} : \theta \in \left(\frac{-\pi + 4\pi j - 2\alpha}{2k}, \frac{\pi + 4\pi j - 2\alpha}{2k} \right) \text{ and } r_\theta \in (0, \varepsilon_\theta) \right\} \quad (4)$$

for some positive ε_θ and $j = 0, 1, \dots, k-1$ (and $|f(z)| < |f(z_0)|$ if z is in any of the alternate wedges).

Since $f'(z_0) = 0$, $k \geq 2$. To complete the proof, note that at least one of the k wedges described in (4) must intersect D . Hence $|f(z_0)|$ cannot be the maximum value of $|f|$ on D . \square

Remarks

1. While the theorem asserts that $|f|$ cannot achieve an absolute maximum value at a critical point, it is equally true that $|f|$ cannot have a minimum value other than zero at a critical point. This is obvious from the parenthetical remark after (4), above. It can also be proven by considering $1/f$ (which is analytic on an open set containing D if f is nonvanishing on D).
2. Theorem 6.15 is easily generalized to a wide range of compact sets K , including those which do not have smooth boundaries. The key is that, along with each boundary point z_0 , K must also contain a wedge (or “cone”) of the form

$$\left\{ z_0 + r e^{i\theta} : \theta \in [\alpha, \beta], r \in (0, \varepsilon) \right\}$$

with $\varepsilon > 0$ and $\beta - \alpha > \pi/2$. This is sufficient since each of the wedges in (4) has a maximum vertex angle of $\pi/2$. Thus, the theorem would be equally valid for a polygon all of whose vertex angles were obtuse. Without this “cone condition”, however, the theorem is no longer valid. For example, in the unit square $\{z : \operatorname{Re} z, \operatorname{Im} z \in [0, 1]\}$, $z^2 + i$ has *both* an absolute minimum *and* a critical point at 0, and $1/(z^2 + i)$ has *both* an absolute maximum *and* a critical point at 0.

- The ideas in the proof of Theorem 6.15 can be applied to show that the set of interior critical points of an analytic function (except for those which are also zeroes) is identical with the set of its “saddle points”. The details are given below.

6.16 Definition

z_0 is a *saddle point* of an analytic function f if it is a saddle point of the real-valued function $g = |f|$; that is, if g is differentiable at z_0 , with $g_x(z_0) = g_y(z_0) = 0$, but z_0 is neither a local maximum nor a local minimum of g .

6.17 Theorem

z_0 is a *saddle point* of an analytic function f if and only if $f'(z_0) = 0$ and $f(z_0) \neq 0$.

Proof

Let $f = u + iv$, where u and v are real, and let $g = |f|$.

First, suppose that z_0 is a *saddle point* of f . Then $g = |f|$ is differentiable at z_0 , and obviously $g(z_0) \neq 0$. Note that

$$g_x = \frac{(uu_x + vv_x)}{g}, \quad g_y = \frac{(uu_y + vv_y)}{g}. \quad (5)$$

Since $g_x(z_0) = g_y(z_0) = 0$,

$$u(z_0)u_x(z_0) + v(z_0)v_x(z_0) = 0,$$

$$u(z_0)u_y(z_0) + v(z_0)v_y(z_0) = 0.$$

$u(z_0)$ and $v(z_0)$ are not both 0, so the above equations imply that

$$\det \begin{pmatrix} u_x(z_0) & v_x(z_0) \\ u_y(z_0) & v_y(z_0) \end{pmatrix} = 0.$$

From the Cauchy-Riemann equations, it follows that $u_x^2(z_0) + v_x^2(z_0) = 0$, and hence that $f'(z_0) = 0$.

Conversely, if $f'(z_0) = 0$, then $u_x(z_0)$ and $v_x(z_0)$ are both zero, and by the Cauchy-Riemann equations, the same is true for $u_y(z_0)$ and $v_y(z_0)$. It follows from (5) that g is differentiable with $g_x(z_0) = g_y(z_0) = 0$. However, as in the

proof of Theorem 6.15, the facts that $f'(z_0) = 0$ and $f(z_0) \neq 0$ guarantee that z_0 is not an extremal point of g . \square

Note: Of course, if $f(z_0) = 0$, $|f|$ has an absolute minimum at z_0 . If, in addition, $f'(z_0) = 0$, then it follows from the power series expansion of f about z_0 that, for z sufficiently close to z_0 and for some positive constant M ,

$$\| |f(z)| - |f(z_0)| \| \leq |f(z) - f(z_0)| \leq M |z - z_0|^2,$$

showing that $g = |f|$ is differentiable at z_0 with $g_x = g_y = 0$ there. If $f(z_0) = 0$ but $f'(z_0) \neq 0$, it can be shown that $|f|$ is not differentiable at z_0 . (See Bak-Ding-Newman)

These observations can be illustrated by $f(z) = (z - 1)(z - 4)^2$, which has a simple zero at $z = 1$, a critical point but not a zero at $z = 2$, and a critical point at the double zero $z = 4$. The graph of $|f|$ is shown in Figure 1. Note that $|f|$ has a saddle point at $z = 2$ and is not differentiable at $z = 1$.

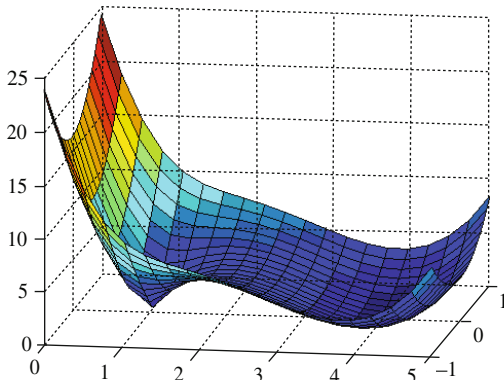

Exercises

1. Find a power series expansion for $1/z$ around $z = 1 + i$.
- 2.* Find a power series, centered at the origin, for the function $f(z) = \frac{1}{1-z-2z^2}$ by first using partial fractions to express $f(z)$ as a sum of two simple rational functions.
3. Using the identity $1/(1-z) = 1 + z + z^2 + \dots$ for $|z| < 1$, find closed forms for the sums $\sum nz^n$ and $\sum n^2 z^n$.
4. Show that if f is analytic in $|z| \leq 1$, there must be some positive integer n such that $f(1/n) \neq 1/(n+1)$.
5. Prove that $\sin(z_1 + z_2) = \sin z_1 \cos z_2 + \cos z_1 \sin z_2$.
6. Suppose an analytic function f agrees with $\tan x$, $0 \leq x \leq 1$. Show that $f(z) = i$ has no solution. Could f be entire?

7. Suppose that f is entire and that $|f(z)| \geq |z|^N$ for sufficiently large z . Show that f must be a polynomial of degree at least N .
8. Suppose f is C -analytic in $|z| \leq 1$, $f \ll 2$ for $|z| = 1$, $\text{Im } z \geq 0$ and $f \ll 3$ for $|z| = 1$, $\text{Im } z \leq 0$. Show then that $|f(0)| \leq \sqrt{6}$. [Hint: Consider $f(z) \cdot f(-z)$.]
9. Show directly that the maximum and minimum moduli of e^z are always assumed on the boundary of a compact domain.
10. Find the maximum and minimum moduli of $z^2 - z$ in the disc: $|z| \leq 1$.
- 11.* (A proof, due to Landau, of the maximum modulus theorem) Suppose f is analytic inside and on a circle C with $|f(z)| \leq M$ on C , and suppose z_0 is a point inside C . Use Cauchy's integral formula to show that $|f(z_0)|^n \leq KM^n$, where K is independent of n , and deduce that $|f(z_0)| \leq M$.
12. Suppose f and g are both analytic in a compact domain D . Show that $|f(z)| + |g(z)|$ takes its maximum on the boundary. [Hint: Consider $f(z)e^{i\alpha} + g(z)e^{i\beta}$ for appropriate α and β .]
13. Show that the Fundamental Theorem of Algebra may be derived as a consequence of the Minimum-Modulus Theorem.
14. Suppose $P_n(z) = a_0 + a_1z + \cdots + a_nz^n$ is bounded by 1 for $|z| \leq 1$. Show that $|P(z)| \leq |z|^n$ for all $z \gg 1$. [Hint: Use Exercise 6 of Chapter 5 to show $|a_n| \leq 1$ and then consider $P(z)/z^n$ in the annulus: $1 \leq |z| \leq R$ for "large" R .]
- 15.* Let $f(z) = (z-1)(z-4)^2$. Find the lines (through $z=2$) on which $|f(z)|$ has a relative maximum, and the ones on which $|f(z)|$ has a relative minimum, at $z=2$. (See the figure at the end of the chapter.)
- 16.* Find the saddle point of $f(z) = \frac{(z+1)^2}{z}$ and identify the lines on which it is a relative maximum or a relative minimum of $|f|$.
- 17.* a. Find the saddle points z_1, z_2 of

$$f(z) = \frac{(z-1)^2(z+1)}{z^2}$$

- b. Show that, for $i = 1, 2$

$$|f(z_i)| = \text{Max}|f(z)| \text{ on the circle } |z| = |z_i|.$$

- c. Find lines through z_i on which $|f|$ has a relative maximum or a relative minimum at z_i .

Chapter 7

Further Properties of Analytic Functions

7.1 The Open Mapping Theorem; Schwarz' Lemma

The Uniqueness Theorem (6.9) states that a non-constant analytic function in a region cannot be constant on any open set. Similarly, according to Proposition 3.7, $|f|$ cannot be constant. Thus a non-constant analytic function cannot map an open set into a point or a circular arc. By applying the Maximum-Modulus Theorem, we can derive the following sharper result on the mapping properties of an analytic function.

7.1 Open Mapping Theorem

The image of an open set under a nonconstant analytic mapping is an open set.

Proof

(due to Carathéodory). We will show that if f is non-constant and analytic at α , the image under f of some (small) disc containing α will contain a disc about $f(\alpha)$. Without loss of generality, assume $f(\alpha) = 0$. (Otherwise, consider $f(z) - f(\alpha)$.) By the Uniqueness Theorem, there is a circle C around α such that $f(z) \neq 0$ for $z \in C$. Let $2\epsilon = \min_{z \in C} |f(z)|$. It will follow that the image of the disc bounded by C contains the disc $D(0; \epsilon)$. For assume that $\omega \in D(0; \epsilon)$ and consider $f(z) - \omega$.

For $z \in C$

$$|f(z) - \omega| \geq |f(z)| - |\omega| \geq \epsilon,$$

while at α

$$|f(\alpha) - \omega| = |-\omega| < \epsilon.$$

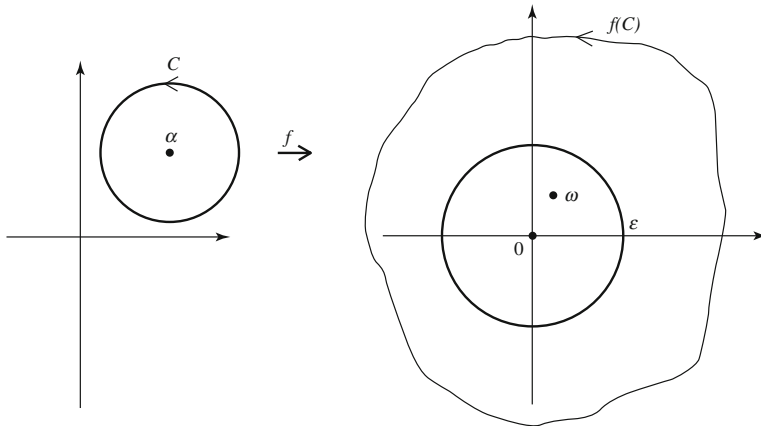

Hence $|f(z) - \omega|$ assumes its minimum somewhere inside C , and by the Minimum Modulus Theorem, $f(z) - \omega$ must equal zero somewhere inside C . Thus ω is in the range of f . \square

The Maximum-Modulus Theorem can also be used in conjunction with other given information about a function to obtain stronger estimates for the modulus of f in its domain of analyticity. The following example is typical.

7.2 Schwarz' Lemma

Suppose that f is analytic in the unit disc, that $f \ll 1$ there and that $f(0) = 0$. Then

- i. $|f(z)| \leq |z|$
- ii. $|f'(0)| \leq 1$

with equality in either of the above if and only if $f(z) = e^{i\theta}z$.

Proof

We apply the Maximum-Modulus Theorem to the analytic function

$$g(z) = \begin{cases} \frac{f(z)}{z} & 0 < |z| < 1 \\ f'(0) & z = 0. \end{cases}$$

(See Proposition 6.7.)

Since $g \ll 1/r$ on the circle of radius r , by letting $r \rightarrow 1$ and applying the Maximum-Modulus Theorem, we find that $|g(z)| \leq 1$ throughout the unit disc, proving (i) and (ii). Furthermore, if $|g(z_0)| = 1$ for some z_0 such that $|z_0| < 1$, then by the Maximum-Modulus Theorem, g would be a constant (of modulus 1), and $f(z) = e^{i\theta}z$. \square

A class of functions analytic in the unit disc and bounded there by 1 is given by the set of bilinear transformations

$$B_\alpha(z) = \frac{z - \alpha}{1 - \bar{\alpha}z}$$

where $|\alpha| < 1$. Note that

$$\left| \frac{1}{\bar{\alpha}} \right| > 1,$$

so that B_α is analytic throughout $|z| \leq 1$. On $|z| = 1$

$$|B_\alpha|^2 = \left(\frac{z - \alpha}{1 - \bar{\alpha}z} \right) \left(\frac{\bar{z} - \bar{\alpha}}{1 - \alpha\bar{z}} \right) = \frac{|z|^2 - \alpha\bar{z} - \bar{\alpha}z + |\alpha|^2}{1 - \alpha\bar{z} - \bar{\alpha}z + |\alpha|^2|z|^2} = 1$$

so that $|B_\alpha| \equiv 1$ on the boundary. For this reason, the functions B_α can be used, in variations of Schwarz' Lemma, to solve various extremal problems for analytic functions.

EXAMPLE 1

Suppose that f is analytic and bounded by 1 in the unit disc and that $f(\frac{1}{2}) = 0$. We wish to estimate $|f(\frac{3}{4})|$. Since $f(\frac{1}{2}) = 0$,

$$g(z) = \begin{cases} f(z) / \left(\frac{z - \frac{1}{2}}{1 - \frac{1}{2}z} \right) & z \neq \frac{1}{2} \\ \frac{3}{4} f' \left(\frac{1}{2} \right) & z = \frac{1}{2} \end{cases}$$

is likewise analytic in $|z| < 1$. Letting $|z| \rightarrow 1$, we find that $|g| \leq 1$; so that

$$|f(z)| \leq \left| \frac{z - \frac{1}{2}}{1 - \frac{1}{2}z} \right|$$

throughout the disc. In particular,

$$\left| f \left(\frac{3}{4} \right) \right| \leq \frac{2}{5}.$$

Note that the maximum value, $\frac{2}{5}$, is achieved by

$$B_{\frac{1}{2}}(z) = \frac{z - \frac{1}{2}}{1 - \frac{1}{2}z}.$$

◇

EXAMPLE 2

Next we show that among all functions f which are analytic and bounded by 1 in the unit disc, $\max |f'(\frac{1}{3})|$ is assumed when $f(\frac{1}{3}) = 0$.

Suppose $f(\frac{1}{3}) \neq 0$ and consider

$$g(z) = \frac{f(z) - f(\frac{1}{3})}{1 - f(\frac{1}{3})f(z)}.$$

Again, since

$$\left| \frac{\omega - f(\frac{1}{3})}{1 - f(\frac{1}{3})\omega} \right| = 1$$

when $|\omega| = 1$, while $|f| < 1$ in $|z| < 1$, the Maximum-Modulus Theorem assures us that g , like f , is bounded by 1. A direct calculations shows that

$$g' \left(\frac{1}{3} \right) = f' \left(\frac{1}{3} \right) / \left(1 - \left| f \left(\frac{1}{3} \right) \right|^2 \right)$$

so that

$$\left| g' \left(\frac{1}{3} \right) \right| > \left| f' \left(\frac{1}{3} \right) \right|.$$

We note that $\max |f'(\frac{1}{3})|$ is assumed by the function $B_{1/3}(z)$. [See Exercises 10 and 11.] \diamond

Example 2 has an interesting physical interpretation. Given the constraint on f that it must map the unit disc into the unit disc, the way to maximize $|f'(\frac{1}{3})|$ is by

- mapping $\frac{1}{3}$ into 0 and
- mapping the boundary of the unit disc onto itself.

It is as though by thus allowing the maximum room for expansion around $f(\frac{1}{3})$, we obtain $\max |f'(\frac{1}{3})|$. We will see a similar phenomenon when we study the Riemann Mapping Theorem.

Returning once again to entire functions, the Maximum-Modulus Theorem may be used to derive further extensions of Liouville's Theorem.

7.3 Proposition

If f is an entire function satisfying

$$|f(z)| \leq 1/|\operatorname{Im} z|$$

for all z , then $f \equiv 0$.

Proof

By hypothesis $f \ll 1$ throughout $|\operatorname{Im} z| > 1$ but f could be unbounded near the real axis. To estimate $|f|$ on the circle $|z| = R$, we introduce the auxiliary function

$$g(z) = (z^2 - R^2)f(z).$$

For any z such that $|z| = R$ and $\operatorname{Re} z \geq 0$

$$|(z - R)f(z)| \leq |z - R|/|\operatorname{Im} z| = \sec \theta$$

for some θ , $0 \leq \theta \leq \pi/4$ (see the following diagram), so that

$$|(z - R)f(z)| \leq \sqrt{2}.$$

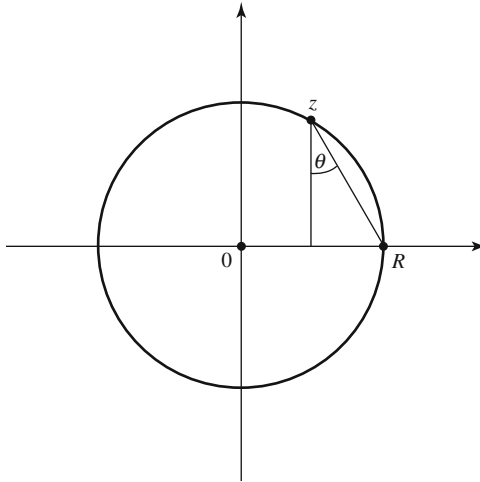

Similarly, if $|z| = R$ and $\operatorname{Re} z \leq 0$, then

$$|(z + R)f(z)| \leq \sqrt{2}.$$

Thus

$$|g(z)| = |z + R||z - R||f(z)| \leq 3R$$

for all z with $|z| = R$. By the Maximum-Modulus Theorem, the same upper bound holds throughout $|z| < R$. Hence

$$|g(z)| = |z^2 - R^2||f(z)| \leq 3R$$

and

$$|f(z)| \leq \frac{3R}{|z^2 - R^2|}$$

as long as $R \gg z$. Letting $R \rightarrow \infty$, we see that $f(z) = 0$. Since this holds for all z , the theorem is proven. \square

7.2 The Converse of Cauchy's Theorem: Morera's Theorem; The Schwarz Reflection Principle and Analytic Arcs

The key result in our study of analytic functions so far has been the Rectangle Theorem (6.1). Thus, it may not come as a surprise that the property described there is almost equivalent to analyticity.

7.4 Morera's Theorem

Let f be a continuous function on an open set D . If

$$\int_{\Gamma} f(z) dz = 0$$

whenever Γ is the boundary of a closed rectangle in D , then f is analytic on D .

Since line integrals are unaffected by the value of the integrand at a single point, the continuity of f is a necessary hypothesis. Note also that in the proof, we actually require only that $\int_{\Gamma} f = 0$ for rectangles whose sides are parallel to the horizontal and vertical axes.

Proof

In a small disc about any point $z_0 \in D$, we can define a primitive

$$F(z) = \int_{z_0}^z f(\zeta) d\zeta$$

where the path of integration is the horizontal followed by the vertical segments from z_0 to z . If we then consider a difference quotient of F and apply the fact that $\int_{\Gamma} f = 0$ around any rectangle, we may conclude (as in Theorems 4.15 and 6.2) that

$$\frac{F(z+h) - F(z)}{h} = \frac{1}{h} \int_z^{z+h} f(\zeta) d\zeta \rightarrow f(z)$$

as $h \rightarrow 0$. (Here we are using the continuity of f .) Hence F is analytic in a neighborhood of z_0 . Since analytic functions are infinitely differentiable and $F'(z) = f(z)$, f is analytic at z_0 . Finally, since z_0 was arbitrary, f is analytic in D . \square

Morera's Theorem is often used to establish the analyticity of functions given in integral form. For example, consider

$$f(z) = \int_0^{\infty} \frac{e^{zt}}{t+1} dt.$$

If $\operatorname{Re} z = x < 0$,

$$\int_0^{\infty} \frac{|e^{zt}|}{t+1} dt < \int_0^{\infty} e^{xt} dt = -\frac{1}{x}$$

so that the integral is absolutely convergent and $|f(z)| \leq 1/|x|$. To show that f is analytic in the left half-plane $D : \operatorname{Re} z < 0$, we may consider

$$\int_{\Gamma} f(z) dz = \int_{\Gamma} \left(\int_0^{\infty} \frac{e^{zt}}{t+1} dt \right) dz,$$

where Γ is the boundary of some closed rectangle in D .

Since

$$\int_{\Gamma} \int_0^{\infty} \frac{|e^{zt}|}{t+1} dt dz$$

converges, we can interchange the order of integration; hence

$$\int_{\Gamma} f = \int_0^{\infty} \int_{\Gamma} \frac{e^{zt}}{t+1} dz dt = \int_0^{\infty} 0 dt = 0$$

by the analyticity of $e^{zt}/(t+1)$ as a function of z . By Morera's Theorem, then, f is analytic in D .

7.5 Definition

Suppose $\{f_n\}$ and f are defined in D . We will say f_n converges to f uniformly on compacta if $f_n \rightarrow f$ uniformly on every compact subset $K \subset D$.

The following theorem asserts that analyticity is preserved under uniform limits, in marked contrast to the property of differentiability on the real line. There, the uniform limit of differentiable functions may be *nowhere* differentiable.

7.6 Theorem

Suppose $\{f_n\}$ represents a sequence of functions, analytic in an open domain D and such that $f_n \rightarrow f$ uniformly on compacta. Then f is analytic in D .

Proof

In some compact neighborhood K of each point z_0 , f is the uniform limit of continuous functions; hence f is continuous in D . Furthermore, for every rectangle $\Gamma \subset K$

$$\int_{\Gamma} f = \int_{\Gamma} \lim f_n = \lim \int_{\Gamma} f_n = 0,$$

since $f_n \rightarrow f$ uniformly on Γ . Hence, by Morera's theorem, f is analytic in D . \square

7.7 Theorem

Suppose f is continuous in an open set D and analytic there except possibly at the points of a line segment L . Then f is analytic throughout D .

Proof

Without loss of generality, we may assume the exceptional points lie on the real axis. Otherwise, we could begin by considering $g(z) = f(Az + B)$ where $Az + B$ maps the real axis onto the line containing L . (See Exercise 15.) Of course, the analyticity of f on D is equivalent to the analyticity of g on the corresponding region. Moreover, since analyticity is a local property, we may assume D is a disc.

To show $\int_{\Gamma} f = 0$ for every closed rectangle in D with boundary Γ (and with sides parallel to the real and imaginary axes), we consider three cases.

i. L doesn't meet the rectangle bounded by Γ .

Here $\int_{\Gamma} f = 0$ by the analyticity of f throughout the interior of Γ (Theorem 6.1).

ii. One side of Γ coincides with L .

In this case, we let Γ_{ϵ} be the rectangle composed of the sides of Γ with the bottom (or top) side shifted up (or down) by ϵ in the positive

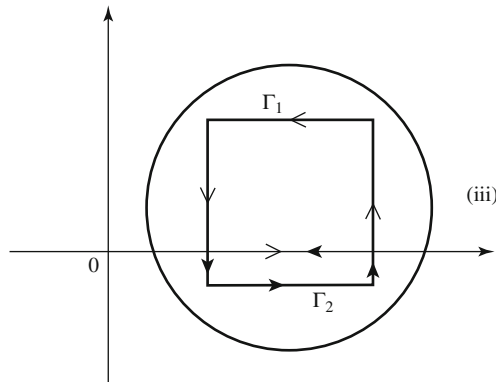
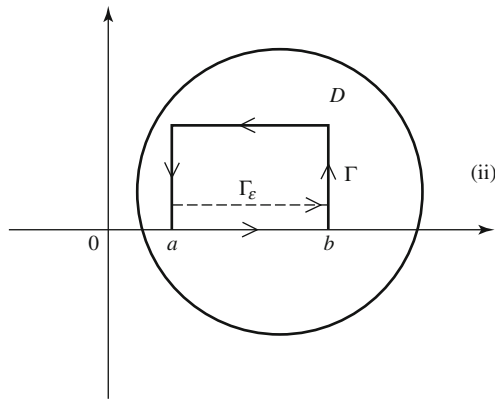

(or negative) y -direction. Then

$$\int_{\Gamma} f = \lim_{\epsilon \rightarrow 0} \int_{\Gamma_{\epsilon}} f,$$

since

$$\int_a^b f(x + i\epsilon) dx \rightarrow \int_a^b f(x) dx$$

by the continuity of f . Hence

$$\int_{\Gamma} f = 0,$$

iii. If Γ surrounds L , we write

$$\int_{\Gamma} f = \int_{\Gamma_1} f + \int_{\Gamma_2} f$$

where Γ_1 and Γ_2 are as in (ii). Again we conclude

$$\int_{\Gamma} f = 0.$$

Finally, By Morera's Theorem, f is analytic in D . □

A wide range of results, all of which are known as the Schwarz Reflection Principle, are typified by the following theorem.

7.8 Schwarz Reflection Principle

Suppose f is C -analytic in a region D that is contained in either the upper or lower half plane and whose boundary contains a segment L on the real axis, and suppose f is real for real z . Then we can define an analytic "extension" g of f to the region $D \cup L \cup D^$ that is symmetric with respect to the real axis by setting*

$$g(z) = \begin{cases} f(z) & z \in D \cup L \\ f(\bar{z}) & z \in D^* \end{cases}$$

where $D^* = \{z : \bar{z} \in D\}$.

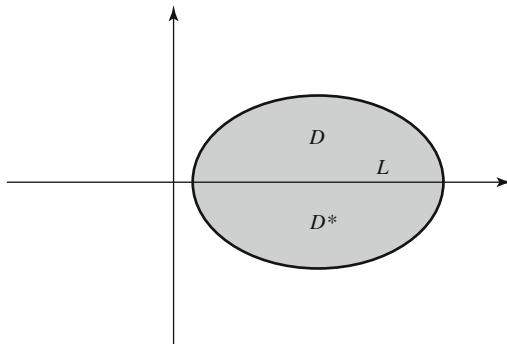

Proof

At points in D , $g = f$ and hence g is analytic there. If $z \in D^*$ and h is small enough so that $z + h \in D^*$

$$\frac{g(z+h) - g(z)}{h} = \frac{f(\bar{z} + \bar{h}) - f(\bar{z})}{h} = \overline{\left[\frac{f(\bar{z} + \bar{h}) - f(\bar{z})}{\bar{h}} \right]}$$

which approaches $\overline{f'(\bar{z})}$ as h approaches 0. Hence g is analytic in D^* . Since f is continuous on the real axis, so is g and we can apply Theorem 7.7 to conclude that g is analytic throughout the region $D \cup L \cup D^*$. \square

By invoking the Uniqueness Theorem, we obtain the following immediate corollary:

7.9 Corollary

If f is analytic in a region symmetric with respect to the real axis and if f is real for real z , then

$$f(z) = \overline{f(\bar{z})}.$$

The Schwarz reflection principle can be applied in more general situations. The key is to extend the concept of reflection across other curves.

7.10 Definition

A curve $\gamma: [a, b] \rightarrow \mathbb{C}$ will be called a regular analytic arc if γ is an analytic, one-to-one function on $[a, b]$ with $\gamma' \neq 0$.

Note that, by the definition of analyticity, γ is the restriction to $[a, b]$ of a function $\gamma(z)$ which is analytic in an open set S containing $[a, b]$. Moreover, if all points of S are sufficiently close to $[a, b]$, $\gamma' \neq 0$ and γ will remain one-to-one throughout S . (Otherwise, the original curve would fail to be one-to-one or γ' would be zero at some point of $[a, b]$.) So assume that $\gamma(z)$ is analytic and one-to-one in such an open set S which is also symmetric with respect to the interval $[a, b]$. Then we can define the reflection w^* of a point w in $\gamma(S)$, across the curve γ , as $\gamma(\overline{\gamma^{-1}(w)})$. That is, if $w = \gamma(z)$, $w^* = \gamma(\bar{z})$. It follows immediately that $(w^*)^* = w$, that points on the original curve are reflected into themselves, and that points not on the curve γ are reflected onto other points not on γ . In fact, the arc formed by taking the image under γ of the vertical line from any nonreal z to its conjugate \bar{z} must intersect the original curve γ (i.e. $\gamma(t)$, $a \leq t \leq b$) orthogonally, by the conformality of γ . Hence w and w^* are on opposite sides of γ .

For example, if $\gamma(t) = it$, $-\infty < t < \infty$, and $w = u + iv$, then $w^* = \gamma(\overline{\gamma^{-1}(w)}) = -u + iv = -\bar{w}$, which is the reflection of w across the imaginary axis. Similarly, suppose γ is an arc of the circle $\gamma(t) = Re^{it}$. Then $\gamma(z) = Re^{iz} = Re^{-y}e^{ix}$. If $w = \gamma(z) = re^{i\theta}$, $Re^{-y} = r$ and $x = \theta$, so that $w^* = \gamma(x - iy) =$

$\frac{R^2}{r}e^{i\theta} = \frac{R^2}{\bar{w}}$. Note that w^* is on the same ray as w , and $|ww^*| = R^2$, so that w and w^* are on opposite sides of the circle of radius R .

Suppose then that f is analytic in a region S and continuous to the boundary, which includes the regular analytic curve γ , and assume that $f(\gamma) \subset \lambda$, another regular analytic curve. Let z^* denote the reflection of z across γ , and let w^* denote the reflection of w across λ . Then f can be extended to S^* by defining $f(z)$ at a point $z \in S^*$ as $(f(z^*))^*$. This defines an analytic extension of f to S^* since it is equal to the composition: $\lambda \circ \lambda^{-1} \circ f \circ \gamma \circ \gamma^{-1}$. As in our proof of the original form of the Schwarz reflection principle, the analyticity of f follows from the fact that $\overline{h(\bar{z})}$ is analytic at z (and has a derivative equal to $\overline{h'(\bar{z})}$) whenever h is analytic at \bar{z} .

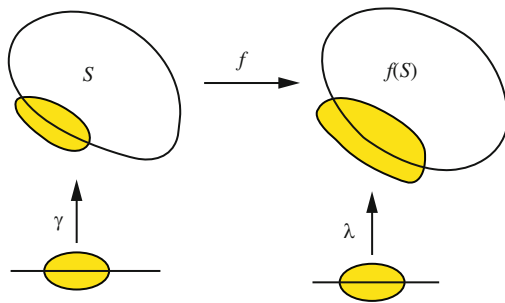

Example 1: Suppose f is analytic in the unit disc and continuous to the boundary, which it maps into itself. Then f can be extended by defining $f(z) = 1/\overline{f(1/\bar{z})}$ at points z outside the unit circle. Note that the extended function is analytic everywhere except at the reflections of the zeroes of f inside the unit circle, which the extended function would map into ∞ . Thus if we were looking for a bilinear function f mapping the unit circle into itself, with $f(\alpha) = 0$, it would follow that $f(1/\bar{\alpha}) = \infty$, so that we might consider $f(z) = (z - \alpha)/(z - 1/\bar{\alpha})$. However, in its current form f does not map the unit circle into itself. In particular, $|f(1)| = |\alpha|$, so we must multiply our function by a constant of magnitude $1/|\alpha|$, which leads us to consider functions of the form $f(z) = (z - \alpha)/(1 - \bar{\alpha}z)$. As we saw in the last section, these bilinear functions do, in fact, map the unit circle into itself. \diamond

Example 2: Suppose f is an analytic map of a rectangle R onto another rectangle S , which maps each side of R onto a side of S . Then f can be extended analytically across the sides of R , mapping rectangles adjacent to R onto rectangles adjacent to S . Continuing in this manner, f can be extended to an entire function! It is easily seen, moreover, that the extended entire function has “linear growth”; i.e. $|f(z)| \leq A|z| + B$, for some positive constants A and B . Hence, according to the Extended Liouville Theorem, f must be a linear polynomial. \diamond

Exercises

- Show that if f is analytic and non-constant on a compact domain, $\operatorname{Re} f$ and $\operatorname{Im} f$ assume their maxima and minima on the boundary.
- Prove that the image of a region under a non-constant analytic function is also a region.
- Suppose f is nonconstant and analytic on S and $f(S) = T$. Show that if $f(z)$ is a boundary point of T , z is a boundary point of S .
 - Let $f(z) = z^2$ on the set S which is the union of the semi-discs $S_1 = \{z : |z| \leq 2; \operatorname{Re} z \leq 0\}$ and $S_2 = \{z : |z| \leq 1; \operatorname{Re} z \geq 0\}$. Show that there are points z on the boundary of S for which $f(z)$ is an interior point of $f(S)$.
- Suppose f is C -analytic in $D(0; 1)$ and maps the unit circle into itself. Show then that f maps the entire disc onto itself. [Hint: Use the Maximum-Modulus Theorem to show that f maps $D(0; 1)$ into itself. Then apply the previous exercise to conclude that the mapping is onto.]
- Suppose f is entire and $|f| = 1$ on $|z| = 1$. Prove $f(z) = Cz^n$. [Hint: First use the maximum and minimum modulus theorem to show

$$f(z) = C \prod_{i=1}^n \frac{z - \alpha_i}{1 - \bar{\alpha}_i z}.$$

- * Show that for any given rational function $f(z)$, with poles in the unit disc, it is possible to find another rational function $g(z)$, with no poles in the unit disc, and such that $|f(z)| = |g(z)|$ if $|z| = 1$.
- *
 - Suppose $|\alpha| < R$. Show that

$$\left| \frac{R(z - \alpha)}{R^2 - \bar{\alpha}z} \right|$$

is analytic for $|z| \leq R$, and maps the circle $|z| = R$ into the unit circle.

- Suppose $|\alpha_k| < R$ for $k = 1, 2, \dots, n$. Prove that (unless $|\alpha_k| = 0$ for all k)

$$\sqrt[n]{|z - \alpha_1| \cdot |z - \alpha_2| \cdots |z - \alpha_n|}$$

assumes a maximum value greater than R , and a minimum value less than R , at some points z

on $|z| = R$. [Hint: Apply the maximum and minimum modulus theorems to $\prod_{k=1}^n (R^2 - \bar{\alpha}_k z)$.]

- Suppose that f is analytic in the annulus: $1 \leq |z| \leq 2$, that $|f| \leq 1$ for $|z| = 1$ and that $|f| \leq 4$ for $|z| = 2$. Prove $|f(z)| \leq |z|^2$ throughout the annulus.
- Given f analytic in $|z| < 2$, bounded there by 10, and such that $f(1) = 0$. Find the best possible upper bound for $|f(\frac{1}{2})|$.
- Suppose that f is analytic and bounded by 1 in the unit disc with $f(\alpha) \neq 0$ for some $\alpha \ll 1$. Show that there exists a function g , analytic and bounded by 1 in the unit disc, with $|g'(\alpha)| > |f'(\alpha)|$.
- Find $\max_f |f'(\alpha)|$ where f ranges over the class of analytic functions bounded by 1 in the unit disc, and α is a fixed point of $|z| < 1$. [Hint: By the previous exercise, you may assume $f(\alpha) = 0$.] Show that

$$f'(\alpha) = \lim_{z \rightarrow \alpha} \frac{f(z)}{z - \alpha} \ll \lim_{z \rightarrow \alpha} \frac{B_\alpha(z)}{z - \alpha} = B'_\alpha(\alpha).$$

- Suppose f is entire and $|f(z)| \leq 1/|\operatorname{Re} z|^2$ for all z . Show that $f \equiv 0$.

13. Show that

$$f(z) = \int_0^1 \frac{\sin zt}{t} dt$$

is an entire function.

- a. by applying Morera's Theorem,
- b. by obtaining a power series expansion for f .

14. With f as in (13) show that

$$f'(z) = \int_0^1 \cos zt dt$$

- a. by writing

$$\begin{aligned} f(z) &= \int_0^1 \int_0^z \cos zt dz dt \\ &= \int_0^z \left(\int_0^1 \cos zt dt \right) dz, \quad \text{etc.,} \end{aligned}$$

- b. by using the power series for f .

15. Show that $g(z) = z_0 + e^{i\theta}z$, $\theta = \text{Arg}(z_1 - z_0)$, maps the real axis onto the line L through z_0 and z_1 .
16. Suppose f is bounded and analytic in $\text{Im } z \geq 0$ and real on the real axis. Prove that f is constant.
17. Given an entire function which is real on the real axis and imaginary on the imaginary axis, prove that it is an odd function: i.e., $f(z) = -f(-z)$.
- 18.* Show that $v + iu$ is the reflection of the point $u + iv$ across the line $u = v$.
19. Suppose f is analytic in the semi-disc: $|z| \leq 1$, $\text{Im } z > 0$ and real on the semi-circle $|z| = 1$, $\text{Im } z > 0$. Show that if we set

$$g(z) = \begin{cases} f(z) & |z| \leq 1, \quad \text{Im } z > 0 \\ \overline{f\left(\frac{1}{\bar{z}}\right)} & |z| > 1, \quad \text{Im } z > 0 \end{cases}$$

then g is analytic in the upper half-plane.

20. Show that there is no non-constant analytic function in the unit disc which is real-valued on the unit circle.
21. Suppose f is analytic in the upper semi-disc: $|z| \leq 1$, $\text{Im } z > 0$ and is continuous to the boundary. Explain why it is not possible that $f(x) = |x|$ for all real values of x .
- 22.* Suppose an entire function maps two horizontal lines onto two other horizontal lines. Prove that its derivative is periodic. [Hint: Assume $f = u + iv$ maps the lines $y = y_1$ and $y = y_2$ onto $v = v_1$ and $v = v_2$ with $y_2 - y_1 = c$ and $v_2 - v_1 = d$. Show then that $f(z + 2ci) = f(z) + 2di$, for all z .]
- 23.* Prove that an entire function which maps a parallelogram onto another parallelogram, and maps each side of the original parallelogram onto a side of its image, must be a linear polynomial. [Hint: Use Exercise 22 to prove that f' is constant.]

Chapter 8

Simply Connected Domains

8.1 The General Cauchy Closed Curve Theorem

As we have seen, it can happen that a function f is analytic on a closed curve C and yet $\int_C f \neq 0$. Perhaps the simplest such example was given by

$$\int_{|z|=1} \frac{1}{z} dz = 2\pi i.$$

On the other hand, the Closed Curve Theorem—6.3—showed that if f is analytic throughout a disc, the integral around any closed curve is 0. We now seek to determine the most general type of domain in which the Closed Curve Theorem is valid. Note that the domain of analyticity of $f(z) = 1/z$ is the punctured plane. We will see that it is precisely the existence of a “hole” at $z = 0$ which allowed the above counterexample. The property of a domain which assures that it has no “holes” is called simple connectedness. The formal definition is as follows.

8.1 Definition

A region D is *simply connected* if its complement is “connected within ϵ to ∞ .” That is, if for any $z_0 \in \tilde{D}$ and $\epsilon > 0$, there is a continuous curve $\gamma(t)$, $0 \leq t < \infty$ such that

- (a) $d(\gamma(t), \tilde{D}) < \epsilon$ for all $t \geq 0$,
- (b) $\gamma(0) = z_0$,
- (c) $\lim_{t \rightarrow \infty} \gamma(t) = \infty$.

A curve γ , satisfying (b) and (c), is said to “connect z_0 to ∞ .” (See Chapter 1.4.)

EXAMPLE 1

The plane minus the real axis is not simply connected since it is not a *region*; that is, a simply connected domain must be connected. \diamond

EXAMPLE 2

The annulus

$$A = \{z : 1 < |z| < 3\}$$

is not simply connected.

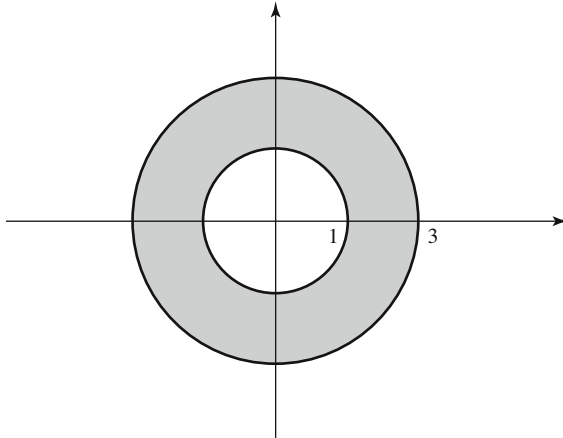

To prove this, note that $0 \in \tilde{A}$ and yet there is no γ which remains within $\epsilon = \frac{1}{2}$ of \tilde{A} and connects 0 to ∞ . If such a γ existed, by the continuity of $|\gamma(t)|$, there would have to be a point t_1 such that $|\gamma(t_1)| = 2$, but then $d(\gamma(t_1), \tilde{D}) = 1$. \diamond

EXAMPLE 3

The unit disc minus the positive real axis is simply connected since for any z_0 in the complement

$$\gamma : \gamma(t) = (t + 1)z_0$$

connects z_0 to ∞ and is contained in the complement.

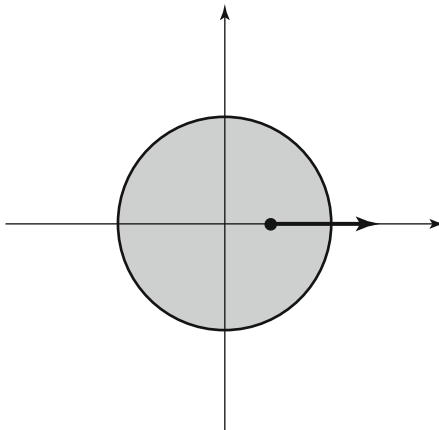
 \diamond

EXAMPLE 4

The infinite strip $S = \{z : -1 < \operatorname{Im} z < 1\}$ is simply connected. Note that in this case, the complement \tilde{S} is not connected.

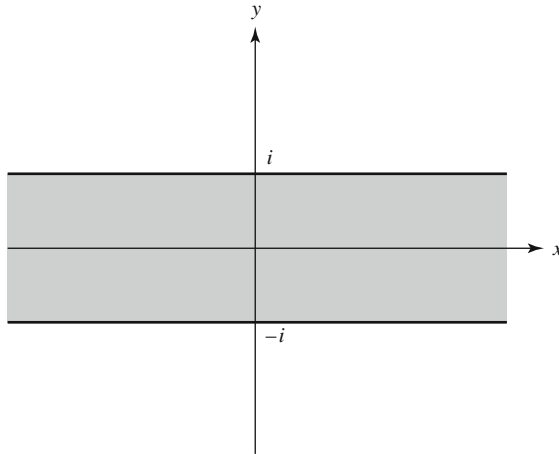

EXAMPLE 5

Any open convex set is simply connected. See Exercises 1 and 2.

Definition 8.1 requires some explanation. It may seem somewhat simpler to say a region D is simply connected if every point in its complement can be connected, by a curve in the complement, to ∞ . However, although this is the case in all the above examples, it is still somewhat too restrictive. For example, suppose the complement is the (connected) set

$$\tilde{D} = \left\{ x + iy : \begin{array}{l} 0 < x \leq 1 \\ y = \sin \frac{1}{x} \end{array} \right\} \cup \{iy : -1 \leq y < \infty\}.$$

By Definition 8.1, D would then be simply connected although the points on the curve $y = \sin(1/x)$ cannot be connected to ∞ by a curve in \tilde{D} . For a comparison of Definition 8.1 with other definitions of simple connectedness, see [Newman, pp. 164ff]. Also, see Appendix I.

Before proving the general closed curve theorem, we first prove an analogue for simple closed polygonal paths. Recall that a polygonal path is a finite chain of horizontal and vertical line segments.

8.2 Definition

Let Γ be a polygonal path. We define the *number of levels* of Γ as the number of *different* values y_0 for which the line $\operatorname{Im} z = y_0$ contains a horizontal

segment of Γ .

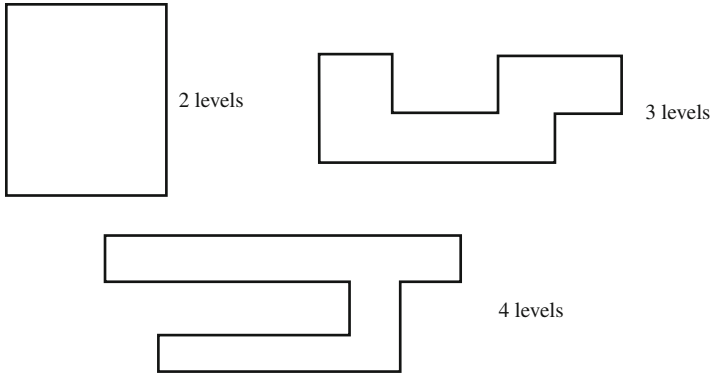

8.3 Lemma

Let Γ be a simple closed polygonal path contained in a simply connected domain D . Suppose the top level of Γ consists of the points $y = y_1, x \in X_1$ and the next level is given by $y = y_2, x \in X_2$. Then the set $R = \{z = x + iy : \begin{smallmatrix} y_2 \leq y \leq y_1 \\ x \in X_1 \end{smallmatrix}\}$ is contained in D .

Proof

Note that R is a finite union of disjoint closed rectangles. We will show that for any $z_0 \in R$ and any curve γ connecting z_0 to $\infty, \gamma \cap \Gamma \neq \emptyset$. Then, since \tilde{D} is closed and Γ is compact, $d(\Gamma, \tilde{D}) = \delta > 0$, and γ would not remain within $\epsilon = \delta/2$ of \overline{D} . Thus $z_0 \in D$.

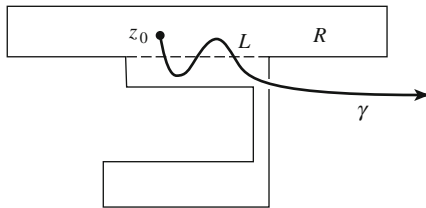

To show $\gamma \cap \Gamma \neq \emptyset$, we proceed by induction on the number of levels of Γ . If Γ has only two levels, it is the boundary of a single rectangle and the proof is straightforward (the details are given in Exercise 5). Otherwise we consider

$$L = \{x + iy : y = y_2, x \in X_1 \setminus X_2\}.$$

Note that z_0 is contained in one of the rectangles of R , so γ must intersect the boundary of R . Thus, if γ doesn't meet $R \cap \Gamma$, it must meet L . Setting

$$t_0 = \sup\{t : \gamma(t) \in R\}$$

we note that for small enough $h > 0$, $\gamma(t_0 + h)$ would be between the top two levels of a simple closed polygonal curve which is a connected component of

$$\Gamma' = (\Gamma \cap \tilde{R}) \cup \bar{L}$$

and has one less level than Γ . But then, by induction $\gamma(t) \in \Gamma'$ for some $t > t_0 + h$. Finally, since $\gamma(t) \notin R$ for $t > t_0$ and since $L \subset R$, $\gamma(t) \in \Gamma$ and the proof is complete. \square

8.4 Theorem

Suppose f is analytic in a simply connected region D and Γ is a simple closed polygonal path contained in D . Then $\int_{\Gamma} f = 0$.

Proof of Theorem 8.4

The proof will again be by induction on the number of levels of Γ . Define L , R and Γ' as in the lemma. We can write

$$\int_{\Gamma} f = \int_{\partial R} f + \int_{\Gamma'} f$$

the integral over L being taken in opposite directions. Since ∂R consists of the boundaries of rectangles and since f is analytic throughout these rectangles (by the lemma), $\int_{\partial R} f = 0$ by the Rectangle Theorem (6.1).

Proceeding by induction on the number of levels of Γ , we may assume

$$\int_{\Gamma'} f = 0$$

since it has one less level than Γ . Hence $\int_{\Gamma} f = 0$ and the proof is complete. \square

8.5 Theorem

If f is analytic in a simply connected region D , there exists a “primitive” F , analytic in D and such that $F' = f$.

Proof

Choose $z_0 \in D$ and define

$$F(z) = \int_{z_0}^z f(\zeta) d\zeta,$$

where the path of integration is a polygonal path contained in D .

By the previous theorem, F is well-defined for if we take Γ_1 and Γ_2 to be two such polygonal paths from z_0 to z ,

$$\int_{\Gamma_1} f - \int_{\Gamma_2} f = \int_{\Gamma} f$$

where Γ is a closed polygonal curve. We leave it as an exercise to show that any closed polygonal curve can be decomposed into a finite number of simple closed polygonal curves and line segments traversed twice in opposite directions. Thus it follows from Lemma 8.3 that $\int_{\Gamma} f = 0$ and $\int_{\Gamma_1} f = \int_{\Gamma_2} f$.

To show that $F' = f$, we consider

$$\frac{F(z+h) - F(z)}{h} = \frac{1}{h} \int_z^{z+h} f(\zeta) d\zeta$$

where now (by taking h small enough), we may take the simplest path of integration: horizontally and then vertically from z to $z+h$. It follows, then, as in Theorems 5.2 and 6.2, that $F'(z) = f(z)$. \square

8.6 General Closed Curve Theorem

Suppose that f is analytic in a simply connected region D and that C is a smooth closed curve contained in D . Then

$$\int_C f = 0.$$

Proof

$$\int_C f = \int_C F'(z) dz$$

where F is the primitive function guaranteed by Theorem 8.5,

$$= F(z(b)) - F(z(a)) = 0$$

since the endpoints of the closed curve coincide. \square

It might be noted that while Theorem 8.6 is stated for simply connected regions, it has implications for other domains as well. For example, if f is analytic in the punctured plane $z \neq 0$ and C is a closed curve in the upper half-plane, $\int_C f = 0$ since C may be viewed as a closed curve in the simply connected subset $\text{Im } z > 0$, where f is analytic. In general, if f is analytic in D and if C is contained in a simply connected subset of D , then $\int_C f = 0$.

EXAMPLE 1

Suppose C is the circle $\alpha + re^{i\theta}$, $0 \leq \theta \leq 2\pi$ and $|a - \alpha| > r$. Then

$$\int_C \frac{dz}{z - a} = 0$$

since $1/(z - a)$ is analytic in the simply connected disc: $|z - \alpha| < |a - \alpha|$ which contains C . (Compare with Lemma 5.4.) \diamond

Cauchy's Theorem also allows us at times to switch an integral along one closed contour to another.

EXAMPLE 2

Suppose f is analytic in the annulus: $1 \leq |z| \leq 4$. Then

$$\int_{|z|=2} f(z)dz = \int_{|z|=3} f(z)dz$$

since, by adding the integrals along the real axis from 2 to 3 and from -2 to -3 in both directions, we can write

$$\int_{|z|=3} f(z)dz - \int_{|z|=2} f(z)dz = \int_{\Gamma_1} f(z)dz + \int_{\Gamma_2} f(z)dz$$

where Γ_1 and Γ_2 are closed curves contained in simply connected subsets of the annulus. (See below.)

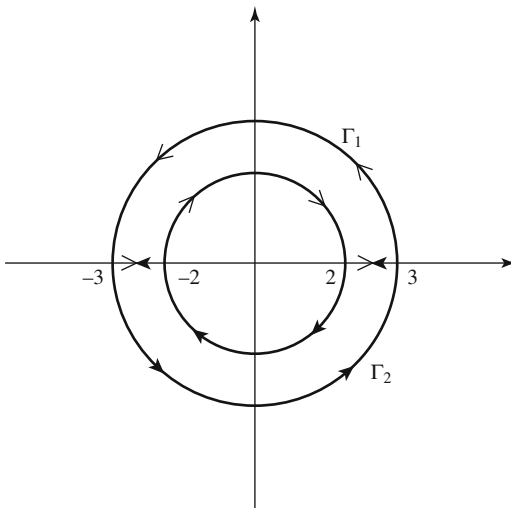

◇

8.2 The Analytic Function $\log z$

8.7 Definition

We will say f is an *analytic branch of $\log z$* in a domain D if

- (1) f is analytic in D , and
- (2) f is an inverse of the exponential function there; i.e., $\exp(f(z)) = z$.

Of course if f is an analytic branch of $\log z$ then so is

$$g(z) = f(z) + 2\pi ki$$

for any fixed integer k .

Since $e^\omega \neq 0$ for any ω , $\log 0$ is not defined. However, for any $z = Re^{i\theta}$, $R > 0$, if we set

$$f(z) = \log z = u(z) + iv(z)$$

condition (2) above becomes

$$\exp(f(z)) = e^{u(z)} \cdot e^{iv(z)} = Re^{i\theta}$$

which is possible if and only if

$$(3) \quad e^{u(z)} = |z| = R$$

and

$$(4) \quad v(z) = \text{Arg } z = \theta + 2k\pi.$$

Hence a function f satisfying (2) can always be found by setting

$$(5) \quad f(z) = u(z) + iv(z) = \log |z| + i \text{Arg } z.$$

However, $\text{Arg } z$ is not a well-defined function [see Chapter 1.2] and even if we adopt a particular convention for $\text{Arg } z$, it is not clear that the function defined in (5) is analytic (or even continuous) in D . However, if D is a simply connected domain not containing 0, we may define an analytic branch of $\log z$ there. (Recall that according to Theorem 3.5 if an analytic inverse of e^z exists, its derivative must be $1/z$. Thus we proceed as follows.)

8.8 Theorem

Suppose that D is simply connected and that $0 \notin D$. Choose $z_0 \in D$, fix a value of $\log z_0$ and set

$$(6) \quad f(z) = \int_{z_0}^z \frac{d\zeta}{\zeta} + \log z_0.$$

Then f is an analytic branch of $\log z$ in D .

Proof

f is well-defined since $1/\zeta$ is an analytic function of ζ in D and hence the integral along any two paths from z_0 to z yield the same value (Theorem 8.5). Furthermore, $f'(z) = 1/z$, so f is analytic in D .

To show that $\exp(f(z)) = z$, we consider

$$g(z) = ze^{-f(z)}.$$

Since $g'(z) = e^{-f(z)} - zf'(z)e^{-f(z)} = 0$, g is constant and

$$g(z) = g(z_0) = z_0e^{-f(z_0)} = 1.$$

Hence

$$e^{f(z)} = z. \quad \square$$

In an analogous manner, we can define an analytic branch of $\log f(z)$ in any simply connected domain where f is analytic and unequal to 0. We simply fix z_0 and a value of $\log f(z_0)$ and set

$$\log f(z) = \int_{z_0}^z \frac{f'(\zeta)}{f(\zeta)} d\zeta + \log f(z_0).$$

In a typical situation, suppose D represents the whole plane minus the non-positive real axis: $x \leq 0$. If we choose $z_0 = 1$ and $\log 1 = 0$ in (6) the resulting function,

$$f(z) = \int_1^z \frac{d\zeta}{\zeta},$$

is an analytic branch of $\log z$ with

$$-\pi < \text{Im}(\log z) = \text{Arg } z < \pi.$$

(This latter inequality can be seen by integrating from 1 to $|z|$ and from $|z|$ to z .)

Similarly, if D is the plane slit along the non-negative real axis and we choose that branch of $\log z$ for which $\log(-1) = \pi i$, we will have defined an analytic branch of $\log z$ with $0 < \text{Arg } z < 2\pi$. [See Exercise 8.]

By proper application of the logarithm, we can also define analytic branches of \sqrt{z} , $z^{1/3}$, etc., in the appropriate domains.

For example, \sqrt{z} may be defined, in any domain where $\log z$ is defined, as

$$(7) \quad \sqrt{z} = \exp\left(\frac{1}{2} \log z\right).$$

Since

$$\left(\exp\left(\frac{1}{2} \log z\right)\right)^2 = \exp(\log z) = z,$$

this does define a “ \sqrt{z} ” and it is analytic where the logarithm is. Note that different branches of $\log z$ may yield different branches of \sqrt{z} . Unlike $\log z$, however, which has infinitely many different branches

$$\log z + 2\pi ki$$

for any integer k , there are only two different branches of \sqrt{z} . This follows from the fact that the equation $w^2 = z$ has exactly two different solutions for any $z \neq 0$. It also follows from (7) since

$$\exp\left(\frac{1}{2} \log z\right) = \exp\left(\frac{1}{2} [\log z + 2\pi ki]\right)$$

if k is even.

The same technique may be used to define arbitrary powers of any nonzero complex number. For example,

$$i^i \equiv e^{i \log i} = \{\dots e^{3\pi/2}, e^{-\pi/2}, e^{-5\pi/2}, \dots\}.$$

Exercises

1. A set S is called *star-like* if there exists a point $\alpha \in S$ such that the line segment connecting α and z is contained in S for all $z \in S$. Show that a star-like region is simply connected. [Hint: Show that $\gamma : \gamma(t) = tz + (1-t)\alpha$, $t \geq 1$ is contained in the complement for any z in the complement.]
- 2.* Prove that every convex region is simply connected.
3. Suppose a region S is simply connected and contains the circle $C = \{z : |z - \alpha| = r\}$. Show then that S contains the entire disc $D = \{z : |z - \alpha| \leq r\}$. [Hint: Show that since S is open (by definition) and C is compact, S contains the annulus $B = \{z : r - \delta \leq |z - \alpha| \leq r + \delta\}$ for some $\delta > 0$.]
4. Show that if

$$\tilde{S} = \left\{ x + iy : \begin{array}{l} 0 < x \leq 1 \\ y = \sin \frac{1}{x} \end{array} \right\} \cup \{iy : -1 \leq y < \infty\},$$

S is simply connected.

- 5.* Show that a polygonal line γ connecting z to ∞ intersects the boundary of every rectangle R containing z . [Hint: Consider $t_0 = \sup\{t : \gamma(t) \in R\}$.]
6. Define the “inside” of a simple closed polygonal path. Show that if such a path is contained in a simply connected domain, so is its “inside.”
7. Show that any closed polygonal path can be decomposed into a finite union of simple closed polygonal paths and line segments traversed twice in opposite directions.
8. Show that $\pi i + \int_{-1}^z d\zeta/\zeta$ defines an analytic branch of $\log z$ in the plane slit along the non-negative axis with $0 < \text{Im} \log z = \text{Arg} z < 2\pi$.
- 9.* Define a function f analytic in the plane minus the non-positive real axis and such that $f(x) = x^x$ on the positive axis. Find $f(i)$, $f(-i)$. Show that $f(\bar{z}) = \overline{f(z)}$ for all z .

Chapter 9

Isolated Singularities of an Analytic Function

9.1 Classification of Isolated Singularities; Riemann's Principle and the Casorati-Weierstrass Theorem

Introduction While we have concentrated until now on the general properties of analytic functions, we now focus on the special behavior of an analytic function in the neighborhood of an “isolated singularity.”

We will use the term *deleted neighborhood of z_0* to denote a set of the form $\{z : 0 < |z - z_0| < d\}$.

9.1 Definition

f is said to have an *isolated singularity at z_0* if f is analytic in a deleted neighborhood D of z_0 but is *not* analytic at z_0 .

Note that, by Theorem 7.7, f must be *discontinuous* at an isolated singularity.

EXAMPLES

- i. The function defined by $f(z) = \begin{cases} \sin z & z \neq 2 \\ 0 & z = 2 \end{cases}$ has an isolated singularity at $z = 2$.
- ii. $g(z) = 1/(z - 3)$ has an isolated singularity at $z = 3$.
- iii. $\exp(1/z)$ has an isolated singularity at $z = 0$. ◇

As we shall soon see, the above examples represent the different types of isolated singularities. These may be classified as follows.

9.2 Definition

Suppose f has an isolated singularity at z_0 .

- i. If there exists a function g , analytic at z_0 and such that $f(z) = g(z)$ for all z in some deleted neighborhood of z_0 , we say f has a *removable singularity* at z_0 (i.e., if the value of f is “corrected” at the point z_0 , it becomes analytic there).

- ii. If, for $z \neq z_0$, f can be written in the form $f(z) = A(z)/B(z)$ where A and B are analytic at z_0 , $A(z_0) \neq 0$, and $B(z_0) = 0$, we say f has a *pole* at z_0 . (If B has a zero of order k at z_0 , we say that f has a pole of order k .)
- iii. If f has neither a removable singularity nor a pole at z_0 , we say f has an *essential singularity* at z_0 .

The following theorems show how the nature of the singularity possessed by a function may be determined by its behavior in a deleted neighborhood of the singularity.

9.3 Riemann's Principle of Removable Singularities

If f has an isolated singularity at z_0 and if $\lim_{z \rightarrow z_0} (z - z_0)f(z) = 0$, then the singularity is removable.

Proof

Consider

$$h(z) = \begin{cases} (z - z_0)f(z) & z \neq z_0 \\ 0 & z = z_0. \end{cases}$$

By hypothesis, h is continuous at z_0 . Since h , like f , is analytic in a deleted neighborhood of z_0 , it follows that h is analytic at z_0 (Theorem 7.7). Since $h(z_0) = 0$, $g(z) = h(z)/(z - z_0)$ is likewise analytic at z_0 and equals f for $z \neq z_0$. \square

9.4 Corollary

If f is bounded in a deleted neighborhood of an isolated singularity, the singularity is removable.

9.5 Theorem

If f is analytic in a deleted neighborhood of z_0 and if there exists a positive integer k such that

$$\lim_{z \rightarrow z_0} (z - z_0)^k f(z) \neq 0 \quad \text{but} \quad \lim_{z \rightarrow z_0} (z - z_0)^{k+1} f(z) = 0,$$

then f has a pole of order k at z_0 .

Proof

If we set

$$g(z) = \begin{cases} (z - z_0)^{k+1} f(z) & z \neq z_0 \\ 0 & z = z_0 \end{cases}$$

then g is continuous and hence analytic at z_0 . Furthermore, since $g(z_0) = 0$,

$$A(z) = \frac{g(z)}{z - z_0} = (z - z_0)^k f(z)$$

is likewise analytic at z_0 , and by hypothesis $A(z_0) \neq 0$. Since

$$f(z) = \frac{A(z)}{(z - z_0)^k} \quad \text{for } z \neq z_0$$

the proof is complete. \square

Note that according to the previous two theorems, there is no analytic function which approaches ∞ like a fractional power of $1/(z - z_0)$ in the neighborhood of an isolated singularity z_0 . For example, if f were analytic in a deleted neighborhood of 0 and satisfied $|f(z)| \leq 1/\sqrt{|z|}$, then by 9.3, f would be bounded since the singularity would be removable. Similarly, given that

$$|f(z)| \leq \frac{1}{|z|^{5/2}},$$

we conclude that $z^2 f(z)$ has a removable singularity at 0. Hence f has a pole of order at most 2 at the origin and, in fact, $f(z) \leq A/|z|^2$.

It also follows that in the neighborhood of an essential singularity, a function f must be not only unbounded but such that, for each integer N , $(z - z_0)^N f(z) \not\rightarrow 0$ as $z \rightarrow z_0$. It does not follow, however, that $f(z) \rightarrow \infty$ as $z \rightarrow z_0$. In fact, the following theorem shows that the set of values assumed by a function in the neighborhood of an essential singularity is "dense" in the whole complex plane. That is, the range of f intersects every disc in \mathbb{C} .

9.6 Casorati-Weierstrass Theorem

If f has an essential singularity at z_0 and if D is a deleted neighborhood of z_0 , then the range $R = \{f(z) : z \in D\}$ is dense in the complex plane.

Proof

Assume there exists some disc with center ω and radius δ which does not intersect R .

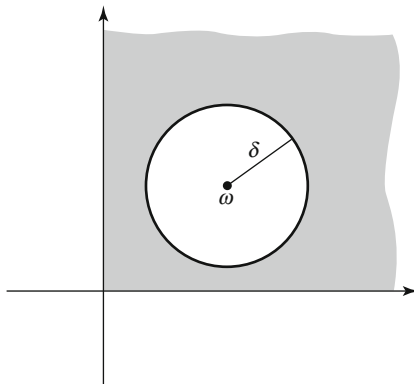

Then $|f(z) - \omega| > \delta$ and

$$\left| \frac{1}{f(z) - \omega} \right| < \frac{1}{\delta} \text{ throughout } D.$$

By Riemann's Principle (9.3), it follows that $1/(f(z) - \omega)$ has (at most) a removable singularity at z_0 . Hence

$$\frac{1}{f(z) - \omega} = g(z)$$

where g is analytic at z_0 . But then

$$f(z) = \omega + \frac{1}{g(z)}$$

so that f has either a pole (if $g(z_0) = 0$) or a removable singularity (if $g(z_0) \neq 0$) at z_0 . \square

There is, in fact, a much stronger form of the Casorati-Weierstrass Theorem—known as Picard's Theorem—which asserts that an analytic function takes every value with at most a single exception in the neighborhood of an essential singularity.

9.2 Laurent Expansions

In Chapter 6, we saw that functions analytic in a disc could be represented there by power series. A somewhat similar representation—by “two-sided power series” of the form $\sum_{k=-\infty}^{\infty} a_k(z - z_0)^k$ —can be derived for functions analytic in an annulus $R_1 < |z - z_0| < R_2$. These two-sided power series, known as Laurent expansions, are valuable tools in the study of isolated singularities.

9.7 Definition

We say $\sum_{k=-\infty}^{\infty} \mu_k = L$ if both $\sum_{k=0}^{\infty} \mu_k$ and $\sum_{k=1}^{\infty} \mu_{-k}$ converge and if the sum of their sums is L .

9.8 Theorem

$f(z) = \sum_{-\infty}^{\infty} a_k z^k$ is convergent in the domain

$$D = \{z : R_1 < |z| \text{ and } |z| < R_2\}$$

where

$$R_2 = 1 / \limsup_{k \rightarrow \infty} |a_k|^{1/k}$$

$$R_1 = \limsup_{k \rightarrow \infty} |a_{-k}|^{1/k}.$$

If $R_1 < R_2$, D is an annulus and f is analytic in D .

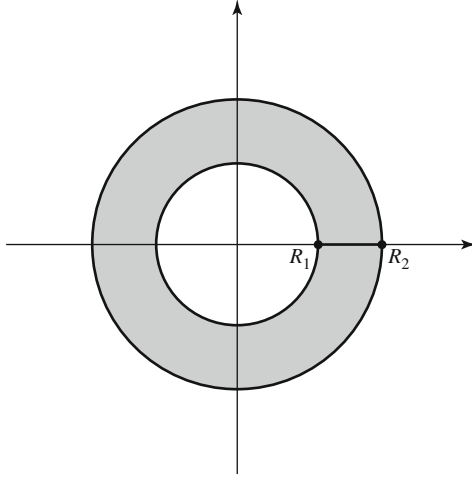

Proof

By Theorem 2.8,

$$f_1(z) = \sum_{k=0}^{\infty} a_k z^k \text{ converges for } |z| < R_2$$

and similarly

$$f_2(z) = \sum_{k=-\infty}^{-1} a_k z^k = \sum_1^{\infty} a_{-k} \left(\frac{1}{z}\right)^k$$

converges for

$$\left| \frac{1}{z} \right| < \frac{1}{R_1}, \text{ or } |z| > R_1.$$

Hence $\sum_{k=-\infty}^{\infty} a_k z^k$ converges for all z in the intersection. Also, since f_1 is a power series and $f_2(z) = g(1/z)$ where g is a power series, f_1 and f_2 are both analytic in their respective domains of convergence. Hence f is analytic in the intersection of these domains. \square

9.9 Theorem

If f is analytic in the annulus $A: R_1 < |z| < R_2$, then f has a Laurent expansion, $f(z) = \sum_{k=-\infty}^{\infty} a_k z^k$, in A .

Proof

Let C_1 and C_2 represent circles centered at 0 of radii r_1 and r_2 , respectively, with $R_1 < r_1 < r_2 < R_2$. Fix z with $r_1 < |z| < r_2$. Then

$$g(w) = \frac{f(w) - f(z)}{w - z}$$

is analytic in A , and by Cauchy's Theorem

$$\int_{C_2-C_1} g(w)dw = 0.$$

(See Example 2 following Theorem 8.6.) Thus

$$\int_{C_2-C_1} \frac{f(z)}{w-z}dw = \int_{C_2-C_1} \frac{f(w)}{w-z}dw. \quad (1)$$

Note then that $\int_{C_2} dw/(w-z) = 2\pi i$, according to Lemma 5.4, while $\int_{C_1} dw/(w-z) = 0$ by Cauchy's Theorem so that

$$\int_{C_2-C_1} \frac{f(z)}{w-z}dw = 2\pi i f(z). \quad (2)$$

Combining (1) and (2), we have

$$f(z) = \frac{1}{2\pi i} \int_{C_2} \frac{f(w)}{w-z}dw - \frac{1}{2\pi i} \int_{C_1} \frac{f(w)}{w-z}dw. \quad (3)$$

Now, on C_2 , $|w| > |z|$ so that

$$\frac{1}{w-z} = \frac{1}{w(1-\frac{z}{w})} = \frac{1}{w} + \frac{z}{w^2} + \frac{z^2}{w^3} + \dots$$

while on C_1 , since $|w| < |z|$,

$$\frac{1}{w-z} = \frac{-1}{z-w} = -\frac{1}{z} - \frac{w}{z^2} - \frac{w^2}{z^3} - \dots,$$

the convergence being uniform in both cases. Substitution into (3), then, yields

$$f(z) = \frac{1}{2\pi i} \int_{C_2} \left(\sum_{k=0}^{\infty} \frac{f(w)z^k}{w^{k+1}} \right) dw + \frac{1}{2\pi i} \int_{C_1} \left(\sum_{k=-1}^{-\infty} \frac{f(w)z^k}{w^{k+1}} \right) dw$$

and switching the order of summation and integration,

$$f(z) = \sum_{k=-\infty}^{\infty} a_k z^k, \quad a_k = \frac{1}{2\pi i} \int_C \frac{f(w)}{w^{k+1}} dw$$

where C is any circle in A centered at 0, for all $z \in A$. For although, in the course of the proof, we have

$$C = \begin{cases} C_2 & \text{for } k \geq 0 \\ C_1 & \text{for } k < 0, \end{cases}$$

in fact C can be taken as any circle in A centered at 0. This follows again from the fact that

$$g(w) = \frac{f(w)}{w^{k+1}}$$

is analytic in A and from the Cauchy Closed Curve Theorem. \square

Note that the Laurent expansion is unique. That is, if

$$f(z) = \sum_{-\infty}^{\infty} a_n z^n$$

in an annulus, then

$$a_k = \frac{1}{2\pi i} \int_C \frac{f(z)}{z^{k+1}} dz \quad (4)$$

where C is as above. For if $\sum_{-\infty}^{\infty} a_n z^n$ converges in A , it converges uniformly along C , and thus

$$\int_C \frac{f(z)}{z^{k+1}} dz = \sum_{n=-\infty}^{\infty} \int_C a_n z^{n-k-1} dz. \quad (5)$$

Since

$$\int_C z^p dz = \begin{cases} 2\pi i & p = -1 \\ 0 & \text{any integer } p \neq -1, \end{cases}$$

it follows that

$$\int_C \frac{f(z)}{z^{k+1}} dz = 2\pi i a_k,$$

proving (4).

9.10 Corollary

If f is analytic in the annulus $R_1 < |z - z_0| < R_2$, then f has a unique representation

$$f(z) = \sum_{-\infty}^{\infty} a_k (z - z_0)^k$$

where

$$a_k = \frac{1}{2\pi i} \int_C \frac{f(z)}{(z - z_0)^{k+1}} dz$$

and $C = C(z_0; R)$ with $R_1 < R < R_2$.

Proof

Simply apply the previous results to $g(z) = f(z + z_0)$, which is analytic in an annulus centered at 0. \square

If we set $R_1 = 0$, we obtain:

9.11 Corollary

If f has an isolated singularity at z_0 , then for some $\delta > 0$, and $0 < |z - z_0| < \delta$

$$f(z) = \sum_{-\infty}^{\infty} a_k (z - z_0)^k,$$

where the a_k are defined as in Corollary 9.10.

EXAMPLES

(i)

$$\frac{(z+1)^2}{z} = \frac{1}{z} + 2 + z \text{ for all } z \neq 0.$$

(ii)

$$\begin{aligned} \frac{1}{z^2(1-z)} &= \frac{1}{z^2}(1+z+z^2+\dots) \\ &= \frac{1}{z^2} + \frac{1}{z} + 1 + z + \dots \text{ for } 0 < |z| < 1. \end{aligned}$$

(iii)

$$\begin{aligned} \frac{1}{z^2(1-z)} &= \frac{-1}{z^2(z-1)} = \frac{-1}{[1+(z-1)]^2(z-1)} \\ &= \frac{-1}{z-1} + 2 - 3(z-1) + 4(z-1)^2 - + \dots \\ &\text{for } 0 < |z-1| < 1. \end{aligned}$$

(iv)

$$\exp(1/z) = 1 + \frac{1}{z} + \frac{1}{2z^2} + \dots \text{ for } z \neq 0.$$

◇

9.12 Definition

If $f(z) = \sum a_k (z - z_0)^k$ is the Laurent expansion of f about an isolated singularity z_0 , $\sum_{-\infty}^{-1} a_k (z - z_0)^k$ is called the *principal part* of f at z_0 ; $\sum_0^{\infty} a_k (z - z_0)^k$ is called the *analytic part*.

Because of the uniqueness of the Laurent expansion, we can derive the following characterizations of the principal parts around the different types of singularities.

(i) If f has a removable singularity at z_0 , all the coefficients C_{-k} of its Laurent expansion about z_0 , for $k > 0$, are 0.

Proof

Since $f(z) = g(z)$ for $z \neq z_0$, the Laurent expansion for f must agree with the Taylor expansion for g around z_0 . \square

EXAMPLE

$$\frac{\sin z}{z} = 1 - \frac{z^2}{3!} + \frac{z^4}{5!} - + \cdots .$$

\diamond

(ii) If f has a pole of order k at z_0 , $C_{-k} \neq 0$ but $C_{-N} = 0$ for all $N > k$.

Proof

Since $f(z) = A(z)/B(z)$ where $A(z_0) \neq 0$ and B has a zero of order k at z_0 ,

$$f(z) = \frac{Q(z)}{(z - z_0)^k},$$

where Q is analytic and nonzero at z_0 . Hence if $Q(z) = \sum_{n=0}^{\infty} a_n (z - z_0)^n$, then

$$f(z) = \sum_{n=0}^{\infty} a_n \frac{(z - z_0)^n}{(z - z_0)^k} = \sum_{j=-k}^{\infty} C_j (z - z_0)^j$$

where $C_j = a_{j+k}$. Thus, $C_{-k} = a_0 = Q(z_0) \neq 0$. \square

(iii) If f has an essential singularity at z_0 , it must have infinitely many nonzero terms in its principal part.

Proof

Otherwise $(z - z_0)^N f(z)$ would be analytic at z_0 for large enough N and f would have a pole at z_0 . \square

The so-called partial fraction decomposition of proper rational functions can be derived as a corollary of the theory of Laurent expansions.

9.13 Partial Fraction Decomposition of Rational Functions

Any proper rational function

$$\mathcal{R}(z) = \frac{P(z)}{Q(z)} = \frac{P(z)}{(z - z_1)^{k_1} (z - z_2)^{k_2} \cdots (z - z_n)^{k_n}},$$

where P and Q are polynomials with $\deg P < \deg Q$, can be expanded as a sum of polynomials in $1/(z - z_k)$, $k = 1, 2, \dots, n$.

Proof

Since \mathcal{R} has a pole of order at most k_1 at z_1 ,

$$\mathcal{R}(z) = P_1\left(\frac{1}{z - z_1}\right) + A_1(z)$$

where $P_1(1/(z - z_1))$ is the principal part of \mathcal{R} around z_1 and A_1 is the analytic part. Furthermore

$$A_1(z) = \mathcal{R}(z) - P_1\left(\frac{1}{z - z_1}\right)$$

has a removable singularity at z_1 and the same principal parts as \mathcal{R} at z_2, \dots, z_n . Thus, if we take $P_2(1/(z - z_2))$ to be the principal part of \mathcal{R} around z_2 and proceed inductively, we find

$$A_n(z) = \mathcal{R}(z) - \left[P_1\left(\frac{1}{z - z_1}\right) + P_2\left(\frac{1}{z - z_2}\right) + \dots + P_n\left(\frac{1}{z - z_n}\right) \right]$$

is an entire function (once it is defined “correctly” at z_1, z_2, \dots, z_n). Furthermore, A_n is bounded since \mathcal{R} and all its principal parts approach 0 as $z \rightarrow \infty$. Thus, by Liouville’s Theorem (5.10), A_n is constant; indeed $A_n \equiv 0$. Hence.

$$\mathcal{R}(z) = P_1\left(\frac{1}{z - z_1}\right) + P_2\left(\frac{1}{z - z_2}\right) + \dots + P_n\left(\frac{1}{z - z_n}\right).$$

□

Exercises

1. Suppose $f(z) \rightarrow \infty$ as $z \rightarrow z_0$, an isolated singularity. Show that f has a pole at z_0 .
2. Does there exist a function f with an isolated singularity at 0 and such that $|f(z)| \sim \exp(1/|z|)$ near $z = 0$?
- 3.* Suppose that f is an entire 1 – 1 function. Show that $f(z) = az + b$.
4. Suppose f is analytic in the punctured plane $z \neq 0$ and satisfies $|f(z)| \leq \sqrt{|z|} + 1/\sqrt{|z|}$. Prove f is constant.
- 5.* Suppose f and g are entire functions with $|f(z)| \leq |g(z)|$ for all z . Prove that $f(z) = cg(z)$, for some constant c .
6. Verify directly that $e^{1/z}$ takes every value (with a single exception) in the annulus: $0 < |z| < 1$. What is the missing value?
7. Suppose f and g have poles of order m and n , respectively, at z_0 . What can be said about the singularity of $f + g$, $f \cdot g$, f/g at z_0 ?
- 8.* Suppose f has an isolated singularity at z_0 . Show that z_0 is an essential singularity if and only if there exist sequences $\{a_n\}$ and $\{\beta_n\}$ with $\{a_n\} \rightarrow z_0$, $\{\beta_n\} \rightarrow z_0$, $\{f(a_n)\} \rightarrow 0$, and $\{f(\beta_n)\} \rightarrow \infty$.

9. Classify the singularities of

- a. $\frac{1}{z^4 + z^2}$
- b. $\cot z$
- c. $\csc z$
- d. $\frac{\exp(1/z^2)}{z - 1}$.

10.* Find the principal part of the Laurent expansion of

$$f(z) = \frac{1}{(z^2 + 1)^2}$$

about the point $z = i$.

11. Find the Laurent expansion for

- a. $\frac{1}{z^4 + z^2}$ about $z = 0$
- b. $\frac{\exp(1/z^2)}{z - 1}$ about $z = 0$
- c. $\frac{1}{z^2 - 4}$ about $z = 2$.

12.* Find the Laurent expansion of $f(z) = \frac{1}{z(z-1)(z-2)}$ (in powers of z) for

- a. $0 < |z| < 1$
- b. $1 < |z| < 2$
- c. $|z| > 2$.

13.* Let $\{a_1, a_2, \dots, a_k\}$ be a set of positive integers and

$$R(z) = \frac{1}{(z^{a_1} - 1)(z^{a_2} - 1) \cdots (z^{a_k} - 1)}.$$

Find the coefficient c_{-k} in the Laurent expansion for $R(z)$ about the point $z = 1$.

14. Show that if f is analytic in $z \neq 0$ and “odd” (i.e., $f(-z) = -f(z)$) then all the even terms in its Laurent expansion about 0 are 0.

15. Find partial fraction decompositions for

- a. $\frac{1}{z^4 + z^2}$
- b. $\frac{1}{z^2 + 1}$.

16. Suppose f is analytic in a deleted neighborhood D of z_0 except for poles at all points of a sequence $\{z_n\} \rightarrow z_0$. (Note that z_0 is *not* an isolated singularity.) Show that $f(D)$ is dense in the complex plane. [*Hint*: Assume, as in the proof of the Casorati-Weierstrass Theorem, that $|f(z) - w| > \delta$ and consider $g(z) = 1/(f(z) - w)$.]

17. Show that the image of the unit disc minus the origin under

$$f(z) = \csc 1/z$$

is dense in the complex plane

- a. by noting that $\sin(1/z)$ has an essential singularity at $z = 0$,
 - b. by applying Exercise 16 to $f(z)$.
18. Prove that the image of the plane under a nonconstant entire mapping is dense in the plane. [*Hint*: If f is not a polynomial, consider $f(1/z)$.]

Chapter 10

The Residue Theorem

10.1 Winding Numbers and the Cauchy Residue Theorem

We now seek to generalize the Cauchy Closed Curve Theorem (8.6) to functions which have isolated singularities. Note that by 9.10 and 9.11, if γ is a circle surrounding a single isolated singularity z_0 and $f(z) = \sum_{-\infty}^{\infty} C_k(z - z_0)^k$ in a deleted neighborhood of z_0 that contains γ , then

$$\int_{\gamma} f = 2\pi i C_{-1}.$$

Thus the coefficient C_{-1} is of special significance in this context.

10.1 Definition

If $f(z) = \sum_{-\infty}^{\infty} C_k(z - z_0)^k$ in a deleted neighborhood of z_0 , C_{-1} is called the *residue of f at z_0* . We use the notation $C_{-1} = \text{Res}(f; z_0)$.

Evaluation of Residues

(i) If f has a simple pole at z_0 ; i.e., if

$$f(z) = \frac{A(z)}{B(z)}$$

where A and B are analytic at z_0 , $A(z_0) \neq 0$ and B has a simple zero at z_0 , then

$$C_{-1} = \lim_{z \rightarrow z_0} (z - z_0)f(z) = \frac{A(z_0)}{B'(z_0)}. \quad (1)$$

Proof

Since

$$\begin{aligned} f(z) &= \frac{C_{-1}}{z - z_0} + C_0 + C_1(z - z_0) + \cdots, \\ (z - z_0)f(z) &= C_{-1} + C_0(z - z_0) + C_1(z - z_0)^2 + \cdots, \end{aligned}$$

and

$$\lim_{z \rightarrow z_0} (z - z_0)f(z) = C_{-1}.$$

The second equality in (1) follows since

$$\begin{aligned} \lim_{z \rightarrow z_0} (z - z_0)f(z) &= \lim_{z \rightarrow z_0} (z - z_0) \frac{A(z)}{B(z)} \\ &= \lim_{z \rightarrow z_0} A(z) \left/ \frac{B(z) - B(z_0)}{z - z_0} \right. = \frac{A(z_0)}{B'(z_0)}. \end{aligned} \quad \square$$

(ii) If f has a pole of order k at z_0 ,

$$C_{-1} = \frac{1}{(k-1)!} \frac{d^{k-1}}{dz^{k-1}} \left[(z - z_0)^k f(z) \right] \text{ evaluated at } z_0.$$

Proof

Setting

$$\begin{aligned} f(z) &= C_{-k}(z - z_0)^{-k} + \cdots + C_{-1}(z - z_0)^{-1} + C_0 + C_1(z - z_0) + \cdots \\ g(z) &= (z - z_0)^k f(z) = C_{-k} + \cdots + C_{-1}(z - z_0)^{k-1} + C_0(z - z_0)^k + \cdots \\ \frac{d^{k-1}g(z)}{dz^{k-1}} &= (k-1)!C_{-1} + k!C_0(z - z_0) + \cdots \end{aligned}$$

and the equality follows. \square

(iii) In most cases of higher-order poles, as with essential singularities, the most convenient way to determine the residue is directly from the Laurent expansion.

EXAMPLES

- i. $\text{Res}(\csc z; 0) = \frac{1}{\cos 0} = 1.$
- ii. $\text{Res}\left(\frac{1}{z^4 - 1}; i\right) = \frac{1}{4i^3} = \frac{i}{4}.$
- iii. $\text{Res}\left(\frac{1}{z^3}; 0\right) = 0.$
- iv. $\text{Res}\left(\sin \frac{1}{z-1}; 1\right) = 1,$ since

$$\sin \frac{1}{z-1} = \frac{1}{z-1} - \frac{1}{3!(z-1)^3} + \frac{1}{5!(z-1)^5} - + \cdots \quad \diamond$$

Winding Number. To evaluate $\int_{\gamma} f$ when γ is a general closed curve (and when f may have isolated singularities), we introduce the following concept.

10.2 Definition

Suppose that γ is a closed curve and that $a \notin \gamma$. Then

$$n(\gamma, a) = \frac{1}{2\pi i} \int_{\gamma} \frac{dz}{z - a}$$

is called the *winding number of γ around a* .

Note that if γ represents the boundary of a circle (traversed counter-clockwise)

$$n(\gamma, a) = \begin{cases} 1 & \text{if } a \text{ is inside the circle} \\ 0 & \text{if } a \text{ is outside the circle.} \end{cases}$$

The first identity was proven in Lemma 5.4. The second was shown in Example 1 following the Cauchy Closed Curve Theorem. Also, if γ circles the point a k times—i.e., if $\gamma(\theta) = a + re^{i\theta}$, $0 \leq \theta \leq 2k\pi$ —then

$$n(\gamma, a) = \frac{1}{2\pi i} \int_0^{2k\pi} i d\theta = k,$$

which explains the terminology “winding number.”

10.3 Theorem

For any closed curve γ and $a \notin \gamma$, $n(\gamma, a)$ is an integer.

Proof

Suppose γ is given by $z(t)$, $0 \leq t \leq 1$, and set

$$F(s) = \int_0^s \frac{\dot{z}(t)}{z(t) - a} dt, \quad 0 \leq s \leq 1.$$

Then, as we saw in defining the logarithm function (Section 8.2) it follows from

$$\dot{F}(s) = \frac{\dot{z}(s)}{z(s) - a}$$

that

$$(z(s) - a)e^{-F(s)}$$

is a constant, and setting $s = 0$,

$$(z(s) - a)e^{-F(s)} = z(0) - a.$$

Hence

$$e^{F(s)} = \frac{z(s) - a}{z(0) - a}$$

and

$$e^{F(1)} = \frac{z(1) - a}{z(0) - a} = 1$$

since γ is closed; i.e., $z(1) = z(0)$. Thus

$$F(1) = 2\pi ki \text{ for some integer } k$$

and

$$n(\gamma, a) = \frac{1}{2\pi i} F(1) = k.$$

□

It follows from Definition 10.2 that if we fix γ and let a vary, $n(\gamma, a)$ is a continuous function of a (as long as $a \notin \gamma$). Since it is always integer-valued, we conclude that $n(\gamma, a)$ is constant in the connected components of the complement of γ . Moreover, $n(\gamma, a) \rightarrow 0$ as $a \rightarrow \infty$. Hence $n(\gamma, a) = 0$ in the unbounded component of γ (the set of points which can be connected to ∞ without intersecting γ). Some typical examples are illustrated below.

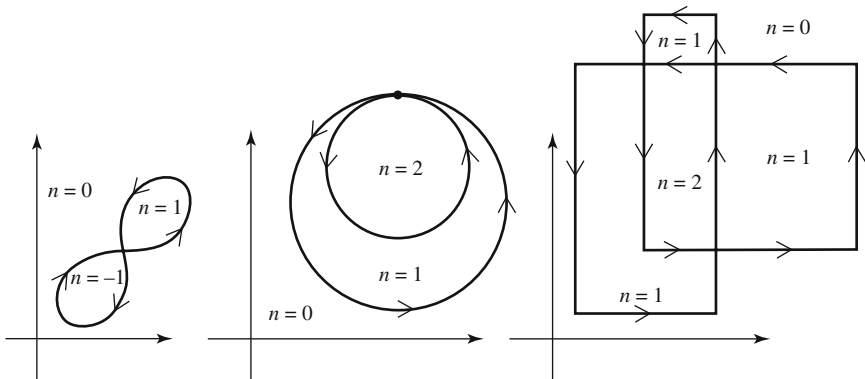

The Jordan Curve Theorem asserts that any simple closed curve divides the plane into exactly two components—one bounded, the other unbounded (here the curve need not necessarily be smooth)—so that if γ is such a “Jordan” curve (and is smooth besides),

$$n(\gamma, a) = \begin{cases} k & \text{if } a \in \text{Bounded Component} \\ 0 & \text{if } a \in \text{Unbounded Component.} \end{cases}$$

The proof of the Jordan Curve Theorem would lead us too far afield. Nevertheless, in all future examples when we deal with simple closed curves, we will be able to verify directly that $n(\gamma, a) = 0$ or ± 1 for all $a \notin \gamma$. In fact, by choosing the “proper” orientation, we will be able to show that $n(\gamma, a) = 0$ or 1 for all $a \notin \gamma$. (The “proper” orientation will be easily recognized as that one for which the bounded component of $\tilde{\gamma}$ lies to the left of γ .)

EXAMPLE

Let γ be a semicircle traversed counterclockwise. Then

$$n(\gamma, a) = \begin{cases} 1 & \text{if } a \text{ is inside the semicircle} \\ 0 & \text{if } a \text{ is outside.} \end{cases}$$

The first assertion can be seen by citing the Closed Curve Theorem to show

$$\int_{\gamma} \frac{dz}{z - a} = \int_C \frac{dz}{z - a}$$

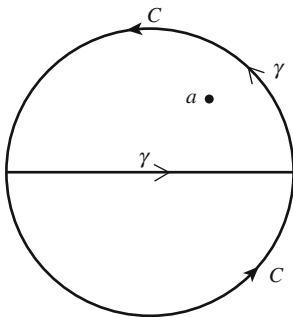

where C is the completed circle containing $z = a$. The second follows from the analyticity of $1/(z - a)$ in a half-plane containing γ but not a .

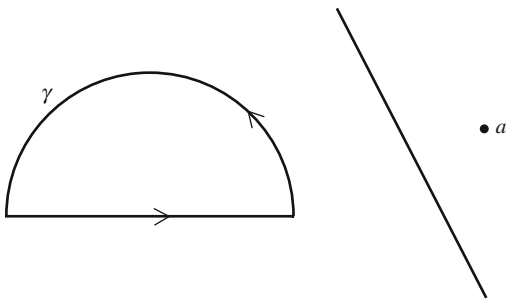

◇

To simplify our terminology, we introduce the following definition.

10.4 Definition

γ is called a *regular closed curve* if γ is a simple closed curve with $n(\gamma, a) = 0$ or 1 for all $a \notin \gamma$. In that case, we will call $\{a : n(\gamma, a) = 1\}$ the *inside* of γ . The set of points a where $n(\gamma, a) = 0$ is called the *outside* of γ .

10.5 Cauchy's Residue Theorem

Suppose f is analytic in a simply connected domain D except for isolated singularities at z_1, z_2, \dots, z_m . Let γ be a closed curve not intersecting any of the singularities.

Then

$$\int_{\gamma} f = 2\pi i \sum_{k=1}^m n(\gamma, z_k) \operatorname{Res}(f; z_k).$$

Proof

(Note that since γ is a “general” curve, we cannot replace it by a finite union of “familiar” curves. Instead we proceed as in Section 9.2.)

If we subtract the principal parts

$$P_1\left(\frac{1}{z-z_1}\right), \dots, P_m\left(\frac{1}{z-z_m}\right)$$

from f , the difference

$$g(z) = f(z) - P_1\left(\frac{1}{z-z_1}\right) - P_2\left(\frac{1}{z-z_2}\right) - \dots - P_m\left(\frac{1}{z-z_m}\right)$$

(with the appropriate definitions at z_1, \dots, z_m) is an analytic function in D . Hence, by the Closed Curve Theorem (8.6)

$$\int_{\gamma} g = 0$$

and

$$\int_{\gamma} f = \sum_{k=1}^m \int_{\gamma} P_k\left(\frac{1}{z-z_k}\right) dz. \quad (3)$$

Furthermore, for any k ,

$$\int_{\gamma} \frac{1}{(z-z_k)^n} = 0, \quad \text{if } n \neq 1 \text{ since}$$

$(z-z_k)^{-n}$ is the derivative of

$$\frac{(z-z_k)^{1-n}}{1-n},$$

which is analytic along the closed curve γ . Hence if

$$P_k\left(\frac{1}{z-z_k}\right) = \frac{C_{-1}}{z-z_k} + \frac{C_{-2}}{(z-z_k)^2} + \dots,$$

$$\int_{\gamma} P_k\left(\frac{1}{z-z_k}\right) dz = C_{-1} \int_{\gamma} \frac{dz}{z-z_k} = 2\pi i n(\gamma, z_k) \operatorname{Res}(f; z_k)$$

and by (3), the proof is complete. \square

10.6 Corollary

If f is as above, and if γ is a regular closed curve in the domain of analyticity of f , then $\int_{\gamma} f = 2\pi i \sum_k \operatorname{Res}(f; z_k)$, where the sum is taken over all the singularities of f inside γ .

10.2 Applications of the Residue Theorem

10.7 Definition

We say f is *meromorphic* in a domain D if f is analytic there except at isolated poles.

10.8 Theorem

Suppose γ is a regular closed curve. If f is meromorphic inside and on γ and contains no zeroes or poles on γ , and if

\mathbb{Z} = number of zeroes of f inside γ (a zero of order k being counted k times),

\mathbb{P} = number of poles of f inside γ (again with multiplicity),

then

$$\frac{1}{2\pi i} \int_{\gamma} \frac{f'}{f} = \mathbb{Z} - \mathbb{P}.$$

Proof

Note that f'/f is analytic except at the zeroes or poles of f . If f has a zero of order k at $z = a$, that is, if

$$f(z) = (z - a)^k g(z) \quad \text{with } g(z) \neq 0,$$

then

$$f'(z) = (z - a)^{k-1} [kg(z) + (z - a)g'(z)]$$

has a zero of order $k - 1$ at z , and

$$\frac{f'(z)}{f(z)} = \frac{k}{z - a} + \frac{g'(z)}{g(z)}$$

Hence, at each zero of f of order k , f'/f has a simple pole with residue k . Similarly, if

$$f(z) = (z - a)^{-k} g(z),$$

then

$$\frac{f'(z)}{f(z)} = \frac{-k}{z - a} + \frac{g'(z)}{g(z)},$$

so that at each pole of f , f'/f has a simple pole with residue $-k$. By Corollary 10.6, then

$$\frac{1}{2\pi i} \int_{\gamma} \frac{f'}{f} = \sum \text{Res} \left(\frac{f'}{f} \right) = \mathbb{Z} - \mathbb{P}.$$

□

If we take f to be analytic, we obtain

10.9 Corollary (Argument Principle)

If f is analytic inside and on a regular closed curve γ (and is nonzero on γ) then

$$\mathbb{Z}(f) = \text{the number of zeroes of } f \text{ inside } \gamma = \frac{1}{2\pi i} \int_{\gamma} \frac{f'}{f}.$$

Remarks

1. The above is known as the ‘‘Argument Principle’’ because if γ is given by $z(t)$, $0 \leq t \leq 1$,

$$\frac{1}{2\pi i} \int_{\gamma} \frac{f'}{f} = \frac{\log f(z(1)) - \log f(z(0))}{2\pi i} = \frac{1}{2\pi} \Delta \text{Arg } f(z) \quad (1)$$

as z travels around γ from the starting point $z(0)$ to the terminal point $z(1) = z(0)$. To prove (1), we split γ into a finite number of simple arcs

$$\begin{aligned} \gamma_1: z(t), \quad 0 \leq t \leq t_1 \\ \gamma_2: z(t), \quad t_1 \leq t \leq t_2 \\ \dots \\ \gamma_n: z(t), \quad t_{n-1} \leq t \leq t_n = 1. \end{aligned}$$

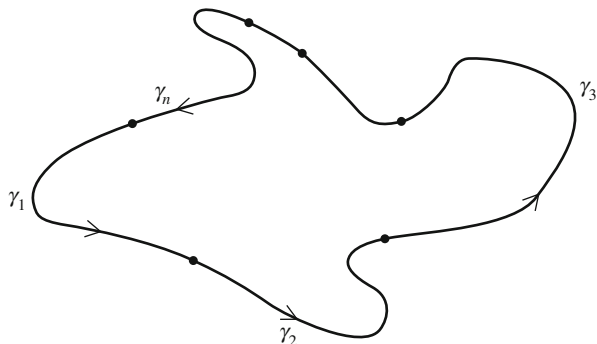

Since an analytic branch of $\log f$ can be defined in a simply connected domain containing γ_1 ,

$$\int_{\gamma_1} \frac{f'}{f} = \log f(z(t_1)) - \log f(z(0)).$$

Similarly

$$\int_{\gamma_k} \frac{f'}{f} = \log f(z(t_k)) - \log f(z(t_{k-1})), \quad k = 2, 3, \dots, n.$$

We note that

$$\int_{\gamma} = \int_{\gamma_1} + \int_{\gamma_2} + \cdots + \int_{\gamma_n},$$

and the first equality in (1) follows. Note, also, that since $z(0) = z(1)$ and since

$$\begin{aligned} \log w &= \log |w| + i \operatorname{Arg} w, \\ \log f(z(1)) - \log f(z(0)) &= i [\operatorname{Arg} f(z(1)) - \operatorname{Arg} f(z(0))], \end{aligned}$$

and the second equality follows.

2. We may also view $\int_{\gamma} f'/f$ as the winding number of the curve $f(\gamma(z))$ around $z = 0$. (See Definition 10.2.) Thus, if f is analytic inside and on γ , the number of zeroes of f inside γ is equal to the number of times that the curve $f(\gamma)$ winds around the origin. By considering $f(z) - a$, it follows that the number of times that $f = a$ inside γ equals the number of times that $f(\gamma)$ winds around the complex number a . As an example, consider the function described in Exercise 3b of Chapter 7.

10.10 Rouché's Theorem

Suppose that f and g are analytic inside and on a regular closed curve γ and that $|f(z)| > |g(z)|$ for all $z \in \gamma$. Then

$$\mathbb{Z}(f + g) = \mathbb{Z}(f) \quad \text{inside } \gamma.$$

Proof

Note first that if $f(z) = A(z)B(z)$

$$\frac{f'}{f} = \frac{A'}{A} + \frac{B'}{B}$$

so that

$$\int_{\gamma} \frac{f'}{f} = \int_{\gamma} \frac{A'}{A} + \int_{\gamma} \frac{B'}{B}.$$

Thus, if we write

$$\begin{aligned} f + g &= f \left(1 + \frac{g}{f} \right), \\ \mathbb{Z}(f + g) &= \frac{1}{2\pi i} \int_{\gamma} \frac{(f + g)'}{f + g} = \frac{1}{2\pi i} \int_{\gamma} \frac{f'}{f} + \frac{1}{2\pi i} \int_{\gamma} \frac{\left(1 + \frac{g}{f} \right)'}{1 + \frac{g}{f}} \\ &= \mathbb{Z}(f) + \frac{1}{2\pi i} \int_{\gamma} \frac{\left(1 + \frac{g}{f} \right)'}{1 + \frac{g}{f}}. \end{aligned}$$

But this last integral is zero since, by hypothesis, $(1 + g/f)(\gamma)$ remains within a disc of radius 1 around $z = 1$. Hence the winding number of $(1 + g/f)(\gamma)$ around 0 is 0 [i.e., setting $\omega = 1 + g/f$ it follows that $\omega(z)$ remains in the right half-plane for $z \in \gamma$ and hence that $\int_{\gamma} \frac{d\omega}{\omega} = 0$.] \square

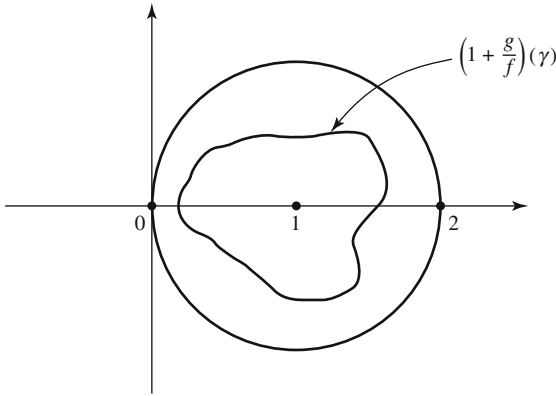

EXAMPLE

Since $|4z^2| > |2z^{10} + 1|$ on $|z| = 1$, each of the polynomials

$$2z^{10} + 4z^2 + 1 \text{ and } 2z^{10} - 4z^2 + 1$$

has exactly two zeroes in $|z| < 1$. \diamond

Recall that according to the Cauchy Integral Formula (6.4)

$$f(z) = \frac{1}{2\pi i} \int_C \frac{f(\omega)}{\omega - z} d\omega$$

where C is a circle containing z . By application of the Residue Theorem, we can extend the result as follows.

10.11 Generalized Cauchy Integral Formula

Suppose that f is analytic in a simply connected domain D and that γ is a regular closed curve contained in D . Then for each z inside γ and $k = 0, 1, 2, \dots$,

$$f^{(k)}(z) = \frac{k!}{2\pi i} \int_{\gamma} \frac{f(\omega)}{(\omega - z)^{k+1}} d\omega.$$

Proof

Note that since

$$f(\omega) = f(z) + f'(z)(\omega - z) + \dots + \frac{f^{(k)}(z)}{k!}(\omega - z)^k + \dots$$

throughout a neighborhood of z ,

$$\operatorname{Res} \left(\frac{f(\omega)}{(\omega - z)^{k+1}}; z \right) = \frac{f^{(k)}(z)}{k!}.$$

Since $f(\omega)/(\omega - z)^{k+1}$ has no other singularities in D , the result follows from Corollary 10.6. \square

We now derive an extension of Theorem 7.6 for the limit of analytic functions.

10.12 Theorem

Suppose a sequence of functions f_n , analytic in a region D , converges to f uniformly on compacta of D . Then f is analytic, $f'_n \rightarrow f'$ in D and the convergence of f'_n is also uniform on compacta of D .

Proof

We proved the analyticity of f in Theorem 7.6. By the Integral Formula 10.11, if we pick any $z_0 \in D$ and let $C = C(z_0; r)$ for some $r < 1$,

$$f'_n(z) - f'(z) = \frac{1}{2\pi i} \int_C \frac{f_n(\omega) - f(\omega)}{(\omega - z)^2} d\omega$$

for all z in $D(z_0; r)$. Moreover, if we take n large enough so that $|f_n - f| < \epsilon r^2/4$ throughout the compact $\overline{D}(z_0; r)$, it follows that

$$|f'_n(z) - f'(z)| < \epsilon$$

for all z in $D(z_0; r/2)$. Thus, to see that the convergence is uniform on compacta, we need only note that any compact subset D can be covered by finitely many discs of the form: $|z - z_0| < r/2$. \square

10.13 Hurwitz's Theorem

Let $\{f_n\}$ be a sequence of non-vanishing analytic functions in a region D and suppose $f_n \rightarrow f$ uniformly on compacta of D . Then either $f \equiv 0$ in D or $f(z) \neq 0$ for all $z \in D$.

Proof

Suppose $f(z) = 0$ for some $z \in D$. If $f \not\equiv 0$, there is some circle C centered at z and such that $f(z) \neq 0$ on C ; hence

$$\frac{f'_n}{f_n} \rightarrow \frac{f'}{f} \quad \text{uniformly on } C.$$

However

$$\frac{1}{2\pi i} \int_C \frac{f'}{f} = \mathbb{Z}(f) \geq 1,$$

while

$$\frac{1}{2\pi i} \int_C \frac{f'_n}{f_n} = \mathbb{Z}(f_n) = 0.$$

Hence

$$f \equiv 0. \quad \square$$

[Note that it is possible to have $f \equiv 0$ despite the fact that $f_n(z) \neq 0$ for all n . Consider, for example, $f_n(z) = (1/n)e^z$.]

EXAMPLE

Since $\sin \pi = 0$, there must be some n_0 such that

$$z - \frac{z^3}{3!} + \frac{z^5}{5!} - + \cdots \frac{z^{2n+1}}{(2n+1)!}$$

has a zero in $|z - \pi| < 1$ for all $n > n_0$. ◇

10.14 Corollary

Suppose that f_n is a sequence of analytic functions in a region D , that $f_n \rightarrow f$ uniformly on compacta in D , and that $f_n \neq a$. Then either $f \equiv a$ or $f \neq a$ in D .

Proof

Consider $g_n(z) = f_n(z) - a$, etc. □

10.15 Theorem

Suppose that f_n is a sequence of analytic functions, and that $f_n \rightarrow f$ uniformly on compacta in a region D . If f_n is 1-1 in D for all n , then either f is constant or f is 1-1 in D .

Proof

Assume $z_1 \neq z_2$, $f(z_1) = f(z_2) = a$ and take disjoint discs D_1 and D_2 (in D) surrounding z_1 and z_2 , respectively. If $f \neq a$, by 10.13, $f_n(z) = a$ must have a solution in D_1 once n is large enough. (Otherwise we could find a subsequence $f_{n_k} \rightarrow f$ with no a -values D_1 .) But then since f_n is 1-1, $f_n(z) \neq a$ throughout D_2 for all large n and hence $f(z_2) \neq a$, contradicting our hypothesis. □

Exercises

1. Determine the singularities and associated residues of

a. $\frac{1}{z^4 + z^2}$

b. $\cot z$

c. $\csc z$

d. $\frac{\exp(1/z^2)}{z-1}$

e. $\frac{1}{z^2 + 3z + 2}$

f. $\sin \frac{1}{z}$

g. $ze^{3/z}$

h. $\frac{1}{az^2 + bz + c}, a \neq 0.$

2. Use the Residue Theorem to evaluate

a. $\int_{|z|=1} \cot z \, dz$

b. $\int_{|z|=2} \frac{dz}{(z-4)(z^3-1)}$

c. $\int_{|z|=1} \sin \frac{1}{z} dz$

d. $\int_{|z|=2} ze^{3/z} dz.$

3. Prove that for any positive integer n , $\text{Res}((1 - e^{-z})^{-n}; 0) = 1$. [Hint: Consider

$$\int_C \frac{dz}{(1 - e^{-z})^n}$$

and make the change of variables $\omega = 1 - e^{-z}$ to show

$$\text{Res}((1 - e^{-z})^{-n}; 0) = \text{Res}\left(\frac{1}{\omega^n(1-\omega)}; 0\right).]$$

- 4.* Show that $\int_{|z|=1} (z + 1/z)^{2m+1} dz = 2\pi i \binom{2m+1}{m}$, for any nonnegative integer m .

- 5.* Let C be a regular curve enclosing the distinct points $\omega_1, \omega_2, \dots, \omega_n$ and let $p(\omega) = (\omega - \omega_1)(\omega - \omega_2) \cdots (\omega - \omega_n)$. Suppose that $f(\omega)$ is analytic in a region that includes C . Show that

$$P(z) = \frac{1}{2\pi i} \int_C \frac{f(\omega)}{p(\omega)} \cdot \frac{p(\omega) - p(z)}{\omega - z} d\omega$$

is a polynomial of degree $n - 1$, with $P(\omega_i) = f(\omega_i)$, $i = 1, 2, \dots, n$.

6. Suppose f is defined by

$$f(z) = \int_{\gamma} \frac{\phi(\omega)d\omega}{\omega - z},$$

where γ is a compact curve, ϕ is continuous on γ , and $z \notin \gamma$. Show that

$$f'(z) = \int_{\gamma} \frac{\phi(\omega)d\omega}{(\omega - z)^2}$$

directly by considering

$$\frac{f(z+h) - f(z)}{h}.$$

Give an alternate proof of Theorem 10.11.

7. Suppose that f is entire and that $f(z)$ is real if and only if z is real. Use the Argument Principle to show that f can have at most one zero. (Compare this with Exercise 13 of Chapter 5.)
- 8.* a. Show that Rouché's Theorem remains valid if the condition: $|f| > |g|$ on γ is replaced by: $|f| \geq |g|$ and $f + g \neq 0$ on γ .
- b. Find the number of zeroes of $z^5 + 2z^4 + 1$ in the unit disc.

9. Find the number of zeroes of

a. $f_1(z) = 3e^z - z$ in $|z| \leq 1$

b. $f_2(z) = \frac{1}{3}e^z - z$ in $|z| \leq 1$

c. $f_3(z) = z^4 - 5z + 1$ in $1 \leq |z| \leq 2$

d. $f_4(z) = z^6 - 5z^4 + 3z^2 - 1$ in $|z| \leq 1$.

10.* Suppose $\lambda > 1$. Show that $\lambda - z - e^{-z} = 0$ has exactly one root (which is a real number) in the right half-plane.

11. Suppose f is analytic inside and on a regular closed curve γ and has no zeroes on γ . Show that if m is a positive integer then

$$\frac{1}{2\pi i} \int_{\gamma} z^m \frac{f'(z)}{f(z)} dz = \sum_k (z_k)^m$$

where the sum is taken over all the zeroes of f inside γ .

12. Show that for each $R > 0$, if n is large enough,

$$P_n(z) = 1 + z + \frac{z^2}{2!} + \cdots + \frac{z^n}{n!} \text{ has no zeroes in } |z| \leq R.$$

13.* a. Let $P(z)$ be any polynomial of the form: $a_0 + a_1z + a_2z^2 + \cdots + a_nz^n$, with all a_i real and $0 \leq a_0 \leq a_1 \leq \cdots \leq a_n$. Prove that all the zeroes of $P(z)$ lie inside the unit disc by applying Rouché's Theorem to $(1-z)P(z)$.

b. Prove that, for any $\rho < 1$, the polynomial $P_n(z) = 1 + 2z + 3z^2 + \cdots + (n+1)z^n$ has no zeroes inside the circle $|z| < \rho$ if n is sufficiently large.

14. Derive the Fundamental Theorem of Algebra as a corollary of Rouché's Theorem.

15. Supply the details of the following proof of Rouché's Theorem (due to Carathéodory). Set

$$J(\lambda) = \frac{1}{2\pi i} \int_{\gamma} \frac{(f + \lambda g)'}{f + \lambda g}, \quad 0 \leq \lambda \leq 1.$$

Note that $J(\lambda)$ is defined for all λ , $0 \leq \lambda \leq 1$. Furthermore $J(\lambda)$ is a continuous function of λ and is always integer-valued. Hence J is constant; in particular, $J(0) = J(1)$ so that

$$\mathbb{Z}(f) = \mathbb{Z}(f + g).$$

16. Recall, as in 8.2, that

$$\log(z^2 - 1) = \int_{\sqrt{2}}^z \frac{2\zeta}{\zeta^2 - 1} d\zeta$$

is analytic in the plane minus the interval $(-\infty, 1]$. Hence, so is

$$\sqrt{z^2 - 1} = \exp\left(\frac{1}{2} \log(z^2 - 1)\right). \quad (1)$$

Show that $\sqrt{z^2 - 1}$ (as defined in (1)) is analytic in the entire plane minus the interval $[-1, 1]$. [Hint: Use the Argument Principle to show that $\sqrt{z^2 - 1}$ is continuous along the interval $(-\infty, -1)$ and then apply Morera's Theorem.]

17. Show that an analytic $\sqrt[3]{(z-1)(z-2)(z-3)}$ can be defined in the entire plane minus $[1, 3]$.

Chapter 11

Applications of the Residue Theorem to the Evaluation of Integrals and Sums

Introduction

In the next section, we will see how various types of (real) definite integrals can be associated with integrals around closed curves in the complex plane, so that the Residue Theorem will become a handy tool for definite integration.

11.1 Evaluation of Definite Integrals by Contour Integral Techniques

I *Integrals of the Form $\int_{-\infty}^{\infty} (P(x)/Q(x))dx$, where P and Q are polynomials.* From real-variable calculus we know that an integral of this type will converge if $Q(x) \neq 0$ and $\deg Q - \deg P \geq 2$. Making these assumptions, we note that

$$\int_{-\infty}^{\infty} \frac{P(x)}{Q(x)} dx = \lim_{R \rightarrow \infty} \int_{-R}^R \frac{P(x)}{Q(x)} dx,$$

and we seek to estimate the second integral for large values of R .

Let C_R be the closed contour consisting of the real line segment from $-R$ to R and the upper semi-circle Γ_R centered at the origin and of radius R large enough to enclose all zeroes of Q lying in the upper half-plane.

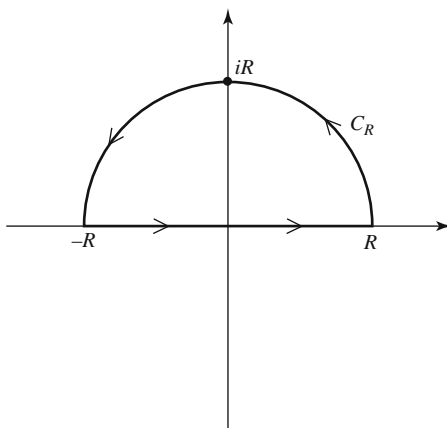

By the Residue Theorem

$$\int_{C_R} \frac{P(z)}{Q(z)} dz = 2\pi i \sum_k \operatorname{Res} \left(\frac{P}{Q}; z_k \right)$$

where the points z_k are the zeroes of Q in the upper half-plane.

Thus

$$\int_{-R}^R \frac{P(x)}{Q(x)} dx + \int_{\Gamma_R} \frac{P(z)}{Q(z)} dz = 2\pi i \sum_k \operatorname{Res} \left(\frac{P}{Q}; z_k \right) \quad (1)$$

To estimate $\int_{\Gamma_R} P/Q$, note that since $\deg Q - \deg P \geq 2$, by the usual $M - L$ estimates

$$\int_{\Gamma_R} \frac{P}{Q} \ll \pi \cdot R \cdot \frac{A}{R^2}$$

and hence

$$\lim_{R \rightarrow \infty} \int_{\Gamma_R} \frac{P(z)}{Q(z)} dz = 0. \quad (2)$$

Combining (1) and (2) shows that

$$\int_{-\infty}^{\infty} \frac{P(x)}{Q(x)} dx = 2\pi i \sum_k \operatorname{Res} \left(\frac{P}{Q}; z_k \right)$$

EXAMPLE

$$\int_{-\infty}^{\infty} \frac{dx}{x^4 + 1} = 2\pi i \sum_{k=1}^2 \operatorname{Res} \left(\frac{1}{z^4 + 1}; z_k \right)$$

where $z_1 = e^{i\pi/4}$ and $z_2 = e^{3\pi i/4}$ represent the poles of $1/(z^4 + 1)$ in the upper half-plane. Since each is a simple pole, the residues are given by the values of $1/4z^3$ at the poles. Thus

$$\operatorname{Res} \left(\frac{1}{z^4 + 1}; e^{i\pi/4} \right) = \frac{1}{4z_1^3} = \frac{-z_1}{4} = -\frac{1}{8}(\sqrt{2} + i\sqrt{2})$$

and

$$\operatorname{Res} \left(\frac{1}{z^4 + 1}; e^{i3\pi/4} \right) = \frac{1}{8}(\sqrt{2} - i\sqrt{2}),$$

so that

$$\int_{-\infty}^{\infty} \frac{dx}{x^4 + 1} = \frac{\pi\sqrt{2}}{2}. \quad \diamond$$

II. Integrals of the Form $\int_{-\infty}^{\infty} \mathcal{R}(x) \cos x dx$ or $\int_{-\infty}^{\infty} \mathcal{R}(x) \sin x dx$. Assuming that

$$\mathcal{R}(x) = \frac{P(x)}{Q(x)}$$

where P and Q are polynomials and $Q(x) \neq 0$ (except perhaps at a zero of $\cos x$ or $\sin x$), the above integrals converge as long as $\deg Q > \deg P$.

Integrating $\mathcal{R}(z) \cos z$ along the same contour as in Type I is not appropriate since

$$\lim_{M \rightarrow \infty} \int_{\Gamma_M} \mathcal{R}(z) \cos z \, dz \neq 0.$$

If we consider

$$\int_{C_M} \mathcal{R}(z) e^{iz} \, dz,$$

however, we will be able to show that

$$\int_{\Gamma_M} \mathcal{R}(z) e^{iz} \, dz \rightarrow 0$$

so that

$$\int_{C_M} \mathcal{R}(z) e^{iz} \, dz \rightarrow \int_{-\infty}^{\infty} \mathcal{R}(x) e^{ix} \, dx. \tag{3}$$

$$\int_{-\infty}^{\infty} \mathcal{R}(x) \cos x \, dx \quad \text{and} \quad \int_{-\infty}^{\infty} \mathcal{R}(x) \sin x \, dx$$

can then be determined as the real and imaginary parts of the limit in (3). Hence, applying the Residue Theorem in (3), we see that

$$\int_{-\infty}^{\infty} \mathcal{R}(x) \cos x \, dx = \operatorname{Re} \left[2\pi i \sum_k \operatorname{Res}(\mathcal{R}(z) e^{iz}; z_k) \right]$$

and $\int_{-\infty}^{\infty} \mathcal{R}(x) \sin x \, dx = \operatorname{Im} [2\pi i \sum_k \operatorname{Res}(\mathcal{R}(z) e^{iz}; z_k)]$, where the points z_k are the poles of $\mathcal{R}(z)$ in the upper half-plane.

To show that $\int_{\Gamma_M} \mathcal{R}(z) e^{iz} \, dz \rightarrow 0$, and complete the argument, we split Γ_M into two subsets:

$$A = \{z \in \Gamma_M : \operatorname{Im} z \geq h\}$$

$$B = \{z \in \Gamma_M : \operatorname{Im} z < h\}.$$

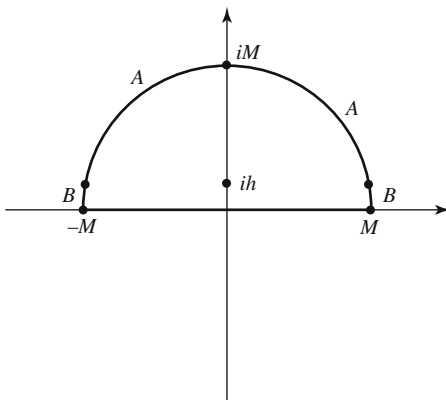

Using the facts that $\mathcal{R}(z) \ll K/|z|$ and $|e^z| = e^{\operatorname{Re} z}$, we obtain

$$\int_A \mathcal{R}(z)e^{iz} dz \ll K \frac{e^{-h}}{M} \cdot \pi M = C_1 e^{-h}.$$

But

$$\int_B \mathcal{R}(z)e^{iz} dz \ll \frac{K}{M} 4h = C_2 \frac{h}{M},$$

so

$$\int_{\Gamma_M} \mathcal{R}(z)e^{iz} dz \ll C_1 e^{-h} + C_2 \frac{h}{M}.$$

If we now choose $h = \sqrt{M}$, for example, we find

$$\int_{\Gamma_M} \mathcal{R}(z)e^{iz} dz \ll C_1 e^{-\sqrt{M}} + \frac{C_2}{\sqrt{M}}$$

and

$$\lim_{M \rightarrow \infty} \int_{\Gamma_M} \mathcal{R}(z)e^{iz} dz = 0.$$

EXAMPLE

To evaluate $\int_{-\infty}^{\infty} (\sin x/x) dx$, we might write

$$\int_{-\infty}^{\infty} \frac{\sin x}{x} dx = \operatorname{Im} \int_{-\infty}^{\infty} \frac{e^{ix}}{x} dx.$$

The pole of e^{ix}/x at $x = 0$ forces us to modify the technique slightly; we write instead:

$$\int_{-\infty}^{\infty} \frac{\sin x}{x} dx = \operatorname{Im} \int_{-\infty}^{\infty} \frac{e^{ix} - 1}{x} dx.$$

Note that

$$\int_{C_M} \frac{e^{iz} - 1}{z} dz = \int_{-M}^M \frac{e^{ix} - 1}{x} dx + \int_{\Gamma_M} \frac{e^{iz} - 1}{z} dz;$$

while, according to Cauchy's Theorem,

$$\int_{C_M} \frac{e^{iz} - 1}{z} dz = 0$$

since the integrand has no poles! Thus

$$\begin{aligned} \int_{-M}^M \frac{e^{ix} - 1}{x} dx &= \int_{\Gamma_M} \frac{1 - e^{iz}}{z} dz = \int_{\Gamma_M} \frac{1}{z} dz - \int_{\Gamma_M} \frac{e^{iz}}{z} dz \\ &= \pi i - \int_{\Gamma_M} \frac{e^{iz}}{z} dz. \end{aligned}$$

Since $\int_{\Gamma_M} (e^{iz}/z) dz$ approaches 0 as $M \rightarrow \infty$,

$$\int_{-\infty}^{\infty} \frac{e^{ix} - 1}{x} dx = \pi i$$

and

$$\int_{-\infty}^{\infty} \frac{\sin x}{x} dx = \pi.$$

◇

III (A) Integrals of the Form $\int_0^{\infty} (P(x)/Q(x)) dx$ As in **I**, to insure convergence of the integral, we assume that $\deg Q - \deg P \geq 2$ and that $Q(x) \neq 0$ for $x \geq 0$. Of course, if the integrand is an even function it can be evaluated as $\frac{1}{2} \int_{-\infty}^{\infty} (P(x)/Q(x)) dx$. In other cases, set $\mathcal{R}(z) = P(z)/Q(z)$ and consider the integral of $\log z \cdot \mathcal{R}(z)$ around the keyhole-shaped contour $K_{\epsilon, M}$ consisting of

- i. the horizontal line segment I_1 from $i\epsilon$ to $\sqrt{M^2 - \epsilon^2} + i\epsilon$;
- ii. the circular arc C_M of radius M traced counterclockwise from

$$\sqrt{M^2 - \epsilon^2} + i\epsilon \text{ to } \sqrt{M^2 - \epsilon^2} - i\epsilon;$$

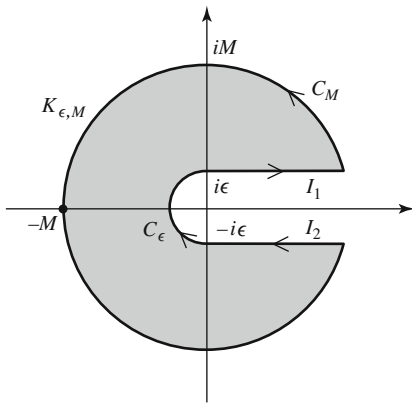

- iii. the horizontal line segment I_2 from

$$\sqrt{M^2 - \epsilon^2} - i\epsilon \text{ to } -i\epsilon;$$

- iv. the semi-circle C_ϵ of radius ϵ traced clockwise from $-i\epsilon$ to $i\epsilon$.

The inside of $K_{\epsilon, M}$ is a simply connected domain not containing 0 and hence $\log z$ may be defined there as an analytic function. (For simplicity, we choose $0 < \text{Arg } z < 2\pi$.)

By the Residue Theorem

$$\lim_{\substack{\epsilon \rightarrow 0 \\ M \rightarrow \infty}} \int_{K_{\epsilon, M}} \mathcal{R}(z) \log z dz = 2\pi i \sum_k \text{Res}(\mathcal{R}(z) \log z; z_k). \tag{4}$$

Moreover, assuming ϵ is small enough and M large enough so that all the zeroes of Q lie inside $K_{\epsilon, M}$, the contour integral is related to $\int_0^\infty \mathcal{R}(x) dx$ as follows:

- i. $\int_{C_\epsilon} \mathcal{R}(z) \log z dz \ll \pi \epsilon \max_{C_\epsilon} |\mathcal{R}(z) \log z| \ll A\epsilon |\log \epsilon|$ since \mathcal{R} is continuous at 0 and $|\log z| < \log |z| + 2\pi$. Thus

$$\lim_{\epsilon \rightarrow 0} \int_{C_\epsilon} \mathcal{R}(z) \log z dz = 0.$$

- ii. $\int_{C_M} \mathcal{R}(z) \log z dz \ll 2\pi M \cdot \max_{C_M} |\log z| |\mathcal{R}(z)| \leq AM \log M / M^2$ since $\mathcal{R}(z) \ll B/|z|^2$, and thus

$$\lim_{M \rightarrow \infty} \int_{C_M} \mathcal{R}(z) \log z dz = 0.$$

- iii. $\lim_{\substack{\epsilon \rightarrow 0 \\ M \rightarrow \infty}} \int_{I_1} \mathcal{R}(z) \log z dz = \int_0^\infty \mathcal{R}(x) \log x dx$ and

$$\lim_{\substack{\epsilon \rightarrow 0 \\ M \rightarrow \infty}} \int_{I_2} \mathcal{R}(z) \log z dz = - \int_0^\infty \mathcal{R}(x) (\log x + 2\pi i) dx.$$

Combining all of the above results we find

$$\lim_{\substack{\epsilon \rightarrow 0 \\ M \rightarrow \infty}} \int_{K_{\epsilon, M}} \mathcal{R}(z) \log z dz = -2\pi i \int_0^\infty \mathcal{R}(x) dx,$$

so that by (4)

$$\int_0^\infty \mathcal{R}(x) dx = - \sum_k \text{Res}(\mathcal{R}(z) \log z; z_k)$$

where the sum is taken over all the poles of \mathcal{R} .

EXAMPLE

To evaluate $\int_0^\infty dx/(1+x^3)$, note that at $z_1 = e^{i\pi/3}$,

$$\text{Res} \left(\frac{\log z}{1+z^3}; z_1 \right) = -\frac{i\pi}{9} \left(\frac{1}{2} + i\frac{\sqrt{3}}{2} \right);$$

at $z_2 = -1 = e^{i\pi}$,

$$\text{Res} \left(\frac{\log z}{1+z^3}; z_2 \right) = \frac{i\pi}{3};$$

and at $z_3 = e^{i5\pi/3}$,

$$\text{Res} \left(\frac{\log z}{1+z^3}; z_3 \right) = \frac{-5\pi i}{9} \left(\frac{1}{2} - i\frac{\sqrt{3}}{2} \right);$$

so that

$$\sum_k \text{Res} \left(\frac{\log z}{1+z^3}; z_k \right) = -\frac{2\pi}{9} \sqrt{3}$$

and

$$\int_0^\infty \frac{dx}{1+x^3} = \frac{2}{9}\pi\sqrt{3}.$$

◇

(B) Integrals of the form $\int_a^\infty (P(x)/Q(x))dx$ can be evaluated in a similar manner by considering

$$\int_{C_M} \log(z-a) \frac{P(z)}{Q(z)} dz$$

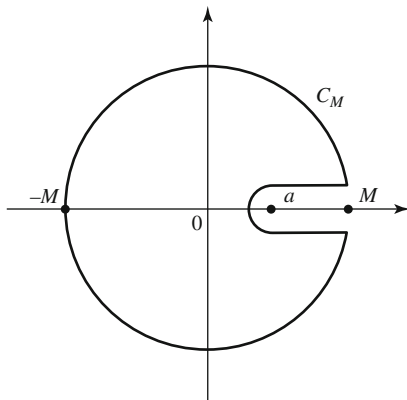

with C_M as indicated. In fact, since

$$\int_0^\infty - \int_a^\infty = \int_0^a,$$

this method can be used to find *indefinite* integrals of rational functions.

(C) Integration around the “keyhole” contour can also be used to evaluate integrals of the form

$$\int_0^\infty \frac{x^{\alpha-1}}{P(x)} dx$$

where $0 < \alpha < 1$ and P is a polynomial with $\deg P \geq 1$.

Throughout the inside of the contour $K_{\epsilon, M}$, $z^{\alpha-1} = \exp[(\alpha-1)\log z]$ can be defined as an analytic function (again, with $0 < \text{Arg } z < 2\pi$, for example).

As we integrate along I_1 (as $\epsilon \rightarrow 0$)

$$z^{\alpha-1} = \exp((\alpha-1)\log x) = x^{\alpha-1}$$

while, throughout I_2

$$z^{\alpha-1} = e^{(\alpha-1)(\log x + 2\pi i)} = x^{\alpha-1} e^{2\pi i(\alpha-1)}.$$

Since the integrals along the two circular segments approach zero as before, the integral around $K_{\epsilon, M}$ is given by the integrals along I_1 and I_2 and hence

$$\left[1 - e^{2\pi i(a-1)}\right] \int_0^\infty \frac{x^{a-1}}{P(x)} dx = 2\pi i \sum_k \operatorname{Res} \left(\frac{z^{a-1}}{P(z)}; z_k \right),$$

the sum being taken over the zeroes of P .

EXAMPLE

To evaluate $\int_0^\infty dx/\sqrt{x}(1+x)$, note that

$$\operatorname{Res} \left(\frac{1}{\sqrt{z}(1+z)}; -1 \right) = -i$$

and

$$(1 - e^{-\pi i}) \int_0^\infty \frac{x}{\sqrt{x}(1+x)} = 2\pi$$

so that

$$\int_0^\infty \frac{dx}{\sqrt{x}(1+x)} = \pi.$$

◇

IV $\int_0^{2\pi} \mathcal{R}(\cos \theta, \sin \theta) d\theta$ where \mathcal{R} Represents a Rational Function Here we take a slightly different point of view. Previously, we viewed the definite integrals as integrals along real line segments which were then supplemented into closed contours in the complex plane. In this case, we think of the real integral itself as the parametric representation of a line integral taken around the unit circle.

Recall that

$$\int_{|z|=1} f(z) dz$$

becomes

$$\int_0^{2\pi} f(e^{i\theta}) i e^{i\theta} d\theta$$

on setting $z = e^{i\theta}$, $0 \leq \theta \leq 2\pi$.

More specifically, the integral $\int_0^{2\pi} \mathcal{R}(\cos \theta, \sin \theta) d\theta$ is equal to

$$\int_{|z|=1} \mathcal{R} \left(\frac{z + \frac{1}{z}}{2}, \frac{z - \frac{1}{z}}{2i} \right) \frac{dz}{iz} \quad (5)$$

since with $z = e^{i\theta}$

$$d\theta = \frac{dz}{iz},$$

$$\cos \theta = \frac{e^{i\theta} + e^{-i\theta}}{2} = \frac{1}{2} \left(z + \frac{1}{z} \right),$$

and

$$\sin \theta = \frac{(e^{i\theta} - e^{-i\theta})}{2i} = \frac{1}{2i} \left(z - \frac{1}{z} \right).$$

The contour integral (5), as always, can be evaluated by the Residue Theorem.

EXAMPLE

$$\begin{aligned} \int_0^{2\pi} \frac{d\theta}{2 + \cos \theta} &= \frac{2}{i} \int_{|z|=1} \frac{dz}{z^2 + 4z + 1} \\ &= 4\pi \operatorname{Res} \left(\frac{1}{z^2 + 4z + 1}; \sqrt{3} - 2 \right) \\ &= \frac{2}{3} \pi \sqrt{3}. \end{aligned} \quad \diamond$$

11.2 Application of Contour Integral Methods to Evaluation and Estimation of Sums

I To evaluate sums of the form $\sum_{n=-\infty}^{\infty} f(n)$, we seek a function g whose residues are given by $\{f(n) : n = 0, \pm 1, \pm 2, \dots\}$.

Suppose we set $g(z) = f(z)\varphi(z)$. Then the function φ should have a simple pole with residue 1 at every integer. Such a function is given by

$$\varphi(z) = \pi \frac{\cos \pi z}{\sin \pi z},$$

since $\sin \pi z$ has a simple zero at every integer and

$$\operatorname{Res} \left(\frac{\pi \cos \pi z}{\sin \pi z}; n \right) = \frac{\pi \cos \pi n}{\pi \cos \pi n} = 1.$$

(Note that $\sin z$ has no other zeroes in the complex plane.)

We first apply the Residue Theorem to the integral

$$\int_{C_N} f(z) \cdot \pi \cot \pi z dz \quad (1)$$

where C_N is a simple closed contour enclosing the integers $n = 0, \pm 1, \pm 2, \dots, \pm N$ and the poles of f (which we assume to be finite in number). Thus

$$\int_{C_N} \pi f(z) \cot \pi z dz = 2\pi i \left[\sum_{\substack{n=-N \\ n \neq z_k}}^N f(n) + \sum_k \operatorname{Res}(f(z)\pi \cot \pi z; z_k) \right] \quad (2)$$

where $\{z_k\}$ are the poles of f .

Furthermore, to insure convergence of $\sum_{n=-\infty}^{\infty} f(n)$, we will assume that $|f(z)| \leq \frac{A}{z^2}$ so that

$$\lim_{z \rightarrow \infty} z f(z) = 0, \quad (3)$$

and by a proper choice of C_N , we will be able to show that

$$\lim_{N \rightarrow \infty} \int_{C_N} f(z) \pi \cot \pi z \, dz = 0. \quad (4)$$

Then by (2)

$$\sum_{\substack{n=-\infty \\ n \neq z_k}}^{\infty} f(n) = - \sum_k \operatorname{Res}(f(z) \pi \cot \pi z; z_k). \quad (5)$$

To demonstrate the existence of a contour C_N satisfying (4), we will let C_N be the square with vertices $\pm(N + \frac{1}{2}) \pm (N + \frac{1}{2})i$. Having thus avoided the poles of $\cot \pi z$, we can show that $|\cot \pi z| < 2$ on C_N . For example, if $\operatorname{Re} z = x = N + \frac{1}{2}$ and $\operatorname{Im} z = y$ then

$$\cot \pi z = i \frac{e^{2\pi iz} + 1}{e^{2\pi iz} - 1} = i \frac{e^{\pi i - 2\pi y} + 1}{e^{\pi i - 2\pi y} - 1}$$

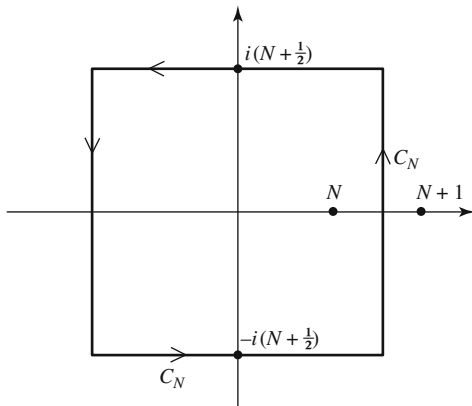

and

$$|\cot \pi z| = \left| \frac{1 - e^{-2\pi y}}{1 + e^{-2\pi y}} \right| < 1.$$

Similarly, if $\operatorname{Im} z = y = N + \frac{1}{2}$

$$|\cot \pi z| \leq \frac{1 + e^{-\pi(2N+1)}}{1 - e^{-\pi(2N+1)}} < 2$$

since the latter expression is maximized at $N = 0$. (The same bounds apply to the other sides of C_N as well, since $\cot z$ is an odd function.)

Since the length of C_N is $8N + 4$, by the usual estimates,

$$\begin{aligned} \int_{C_N} f(z) \pi \cot \pi z &\ll (8N + 4) 2\pi \max_{z \in C_N} |f(z)| \\ &\ll A \max_{c_N} |zf(z)|; \end{aligned}$$

thus

$$\int_{C_N} f(z) \pi \cot \pi z dz \rightarrow 0 \text{ by (3).}$$

EXAMPLE

To find

$$\sum_{n=1}^{\infty} \frac{1}{n^2},$$

note that

$$\sum_{n=1}^{\infty} \frac{1}{n^2} = \frac{1}{2} \sum_{\substack{n=-\infty \\ n \neq 0}}^{\infty} \frac{1}{n^2}$$

and hence, by (5),

$$\sum_{n=1}^{\infty} \frac{1}{n^2} = -\frac{1}{2} \operatorname{Res} \left(\frac{\pi \cot \pi z}{z^2}; 0 \right).$$

The residue can be determined by using the Laurent expansion for $\cot z$; *i.e.*,

$$\cot z = \frac{1}{z} - \frac{z}{3} - \frac{1}{45} z^3 + \dots$$

so that

$$\frac{\pi \cot \pi z}{z^2} = \frac{1}{z^3} - \frac{\pi^2}{3z} - \frac{\pi^4 z}{45} - \dots$$

Thus

$$\operatorname{Res} \left(\frac{\pi \cot \pi z}{z^2}; 0 \right) = \frac{-\pi^2}{3}$$

and

$$\sum_{n=1}^{\infty} \frac{1}{n^2} = \frac{\pi^2}{6}. \quad \diamond$$

II To evaluate sums of the form $\sum_{n=-\infty}^{\infty} (-1)^n f(n)$, where $f(z)$ has a finite number of poles, we integrate again around the square C_N , this time using the auxiliary function $\pi f(z) \csc \pi z$.

Note that

$$\operatorname{Res} \left(\frac{\pi}{\sin \pi z}; n \right) = \frac{1}{\cos \pi n} = (-1)^n,$$

and since

$$\csc^2 \pi z = 1 + \cot^2 \pi z,$$

$\csc \pi z$ (like $\cot \pi z$) is bounded on C_N . Thus we may conclude that

$$\lim_{N \rightarrow \infty} \int_{C_N} \pi f(z) \csc \pi z dz = 0$$

and, by the Residue Theorem, that

$$\sum_{\substack{n=-\infty \\ n \neq z_k}}^{\infty} (-1)^n f(n) = - \sum_k \operatorname{Res}(\pi f(z) \csc \pi z; z_k)$$

where the z_k are the poles of f .

EXAMPLE

$$\begin{aligned} 1 - \frac{1}{4} + \frac{1}{9} - \frac{1}{16} + \dots &= - \sum_{n=1}^{\infty} \frac{(-1)^n}{n^2} = -\frac{1}{2} \sum_{\substack{n=-\infty \\ n \neq 0}}^{\infty} \frac{(-1)^n}{n^2} \\ &= \frac{1}{2} \operatorname{Res} \left(\frac{\pi \csc \pi z}{z^2}; 0 \right) = \frac{\pi^2}{12} \end{aligned}$$

since

$$\frac{\pi \csc \pi z}{z^2} = \frac{1}{z^3} + \frac{\pi^2}{6z} + \frac{7\pi^4 z}{360} + \dots \quad \diamond$$

III Sums Involving Binomial coefficients The connection between binomial coefficients and contour integration is an immediate corollary of the Residue Theorem since

$$\binom{n}{k} = \text{coefficient of } z^k \text{ in } (1+z)^n$$

and hence

$$\binom{n}{k} = \frac{1}{2\pi i} \int_C \frac{(1+z)^n}{z^{k+1}} dz \quad (6)$$

where C is any simple closed contour surrounding the origin. The identity (6) has some immediate consequences. For example,

$$\binom{2n}{n} = \frac{1}{2\pi i} \int_C \frac{(1+z)^{2n}}{z^{n+1}} dz$$

and if we choose C to be the unit circle, we find

$$\binom{2n}{n} \leq 4^n.$$

This same identity (6) can be used to evaluate (or estimate) sums involving binomial coefficients.

EXAMPLE 1

To find

$$\sum_{n=0}^{\infty} \binom{2n}{n} \frac{1}{5^n} = 1 + \frac{2}{5} + \frac{6}{25} + \cdots$$

we set

$$\binom{2n}{n} = \frac{1}{2\pi i} \int_C \frac{(1+z)^{2n}}{z^{n+1}} dz$$

where C is any simple contour surrounding the origin so that

$$\sum_{n=0}^{\infty} \binom{2n}{n} \frac{1}{5^n} = \frac{1}{2\pi i} \sum_{n=0}^{\infty} \int_C \frac{(1+z)^{2n}}{(5z)^n} \frac{dz}{z}. \quad (7)$$

If we could then interchange the order of summation and integration, we would conclude

$$\sum_{n=0}^{\infty} \binom{2n}{n} \frac{1}{5^n} = \frac{5}{2\pi i} \int_C \frac{dz}{3z - 1 - z^2}.$$

However, we must indicate a contour C (surrounding 0) on which summation under the integral sign is justified. [Without this caution, C could be an arbitrary circle centered at 0 and if we let the radius R be large enough, we would conclude erroneously that

$$\sum_{n=0}^{\infty} \binom{2n}{n} \frac{1}{5^n} = 0.]$$

One way to assure the legitimacy of the interchange is to obtain uniform convergence of the series $\sum_{n=0}^{\infty} [(1+z)^2/5z]^n$ throughout C . Thus we pick C to be the unit circle so that

$$\left| \frac{(1+z)^2}{5z} \right| \leq \frac{4}{5}$$

throughout C and the convergence is uniform. Hence

$$\begin{aligned} \sum_{n=0}^{\infty} \binom{2n}{n} \frac{1}{5^n} &= \frac{5}{2\pi i} \int_{|z|=1} \frac{dz}{3z - 1 - z^2} \\ &= 5 \operatorname{Res} \left(\frac{1}{3z - 1 - z^2}; \frac{3 - \sqrt{5}}{2} \right) = \sqrt{5}. \end{aligned}$$

◇

EXAMPLE 2

To evaluate

$$\sum_{k=0}^n \binom{n}{k}^2, \text{ we cast } \binom{n}{k} \text{ in two roles:}$$

- a. $\binom{n}{k}$ = coefficient of z^k in $(1+z)^n$
 b. $\binom{n}{k}$ = coefficient of z^{-k} in $(1+1/z)^n$

so that

$$\sum_{k=0}^n \binom{n}{k}^2 = \text{constant term in } (1+z)^n \left(1 + \frac{1}{z}\right)^n.$$

Thus

$$\begin{aligned} \sum_{k=0}^n \binom{n}{k}^2 &= \frac{1}{2\pi i} \int_C (1+z)^n \left(1 + \frac{1}{z}\right)^n \frac{dz}{z} \\ &= \frac{1}{2\pi i} \int_C \frac{(1+z)^{2n}}{z^{n+1}} dz \\ &= \text{coefficient of } z^n \text{ in } (1+z)^{2n} \\ &= \binom{2n}{n}. \end{aligned}$$

◇

EXAMPLE 3

To estimate

$$1 - \binom{n}{1} \binom{2n}{1} + \binom{n}{2} \binom{2n}{2} - + \cdots \binom{n}{n} \binom{2n}{n}$$

we again note that since

$$\binom{n}{k} = \text{coefficient of } z^k \text{ in } (1+z)^n$$

and since

$$(-1)^k \binom{2n}{k} = \text{coefficient of } \frac{1}{z^k} \text{ in } \left(1 - \frac{1}{z}\right)^{2n},$$

the sum is equal to the constant term in the product and is given by

$$\sum_{k=1}^n (-1)^k \binom{n}{k} \binom{2n}{k} = \frac{1}{2\pi i} \int_C \frac{[(z-1)^2(z+1)]^n}{z^{2n+1}} dz.$$

In this case, however, there is no simple technique for evaluating the integral and instead we seek to estimate it. If we let C be the unit circle, then throughout C ,

$$\left| (z - 1)^2(z + 1) \right| \leq \frac{16}{9}\sqrt{3}$$

[see Exercise 15] and hence

$$\left| \sum_{k=1}^n (-1)^k \binom{n}{k} \binom{2n}{k} \right| \leq \left(\frac{16}{9}\sqrt{3} \right)^n.$$

Note that this estimate is much smaller than one might guess by estimating the size of the various terms—the last term of the series alone is of the order of magnitude of 4^n . (See Exercise 16.) ◇

A more familiar series whose sum is of much smaller magnitude than its individual terms is

$$e^{-x} = 1 - x + \frac{x^2}{2!} - \frac{x^3}{3!} + \dots$$

The fact that $e^{-x} \rightarrow 0$ as $x \rightarrow \infty$ is in sharp contrast to the growth of its individual terms. By employing our contour integral technique, we can demonstrate similar behavior for the series

$$B(x) = 1 - \frac{x}{1} + \frac{x^2}{(2!)^2} - \frac{x^3}{(3!)^2} + \dots$$

that is related to the Bessel Function. Since

$$\frac{1}{n!} = \text{coefficient in } z^n \text{ the expansion of } e^z$$

and

$$\frac{(-x)^n}{n!} = \text{coefficient of } z^{-n} \text{ in } e^{-x/z}$$

$$B(x) = \frac{1}{2\pi i} \int_C \frac{e^z e^{-x/z}}{z} dz$$

where C is any simple contour surrounding 0.

We seek a contour C on which

$$|e^{z-x/z}| = e^{\text{Re}(z-x/z)}$$

is small. Setting $z = Re^{i\theta}$, we find

$$\text{Re}\left(z - \frac{x}{z}\right) = R \cos \theta - \frac{x}{R} \cos \theta;$$

hence $R = \sqrt{x}$ seems a good choice, and we pick C to be the circle: $|z| = \sqrt{x}$.

Then

$$B(x) = \frac{1}{2\pi} \int_0^{2\pi} e^{2i\sqrt{x}\sin\theta} d\theta$$

and since the integrand is bounded by 1 for all θ , we conclude

$$|B(x)| \leq 1$$

for all $x \geq 0$.

(In fact, a closer analysis would show that $B(x) \rightarrow 0$ as $x \rightarrow \infty$, but this would take us too far afield at this point.)

Exercises

1. Evaluate the following definite integrals

a. $\int_{-\infty}^{\infty} \frac{x^2 dx}{(1+x^2)^2}$,

b. $\int_0^{\infty} \frac{x^2 dx}{(x^2+4)^2(x^2+9)}$,

c. $\int_0^{\infty} \frac{dx}{x^4+x^2+1}$,

d. $\int_0^{\infty} \frac{\sin x dx}{x(1+x^2)}$,

e. $\int_0^{\infty} \frac{\cos x dx}{1+x^2}$,

f. $\int_0^{\infty} \frac{dx}{x^3+8}$,

g. $\int_0^{\infty} \frac{x^{\alpha-1}}{1+x} dx$, $0 < \alpha < 1$,

h. $\int_0^{2\pi} \frac{dx}{(2+\cos x)^2}$,

i. $\int_0^{2\pi} \frac{\sin^2 x dx}{5+3\cos x}$,

j. $\int_0^{2\pi} \frac{dx}{a+\cos x}$, (a real), $|a| > 1$.

2. Evaluate

$$\int_0^{\infty} \frac{\sin^2 x}{x^2} dx.$$

[Hint: Integrate $(e^{2iz} - 1 - 2iz)/z^2$ around a large semi-circle.]

3. Evaluate

$$\int_0^{\infty} \frac{dx}{1+x^n}$$

where $n \geq 2$ is a positive integer. [Hint: Consider the following contour.]

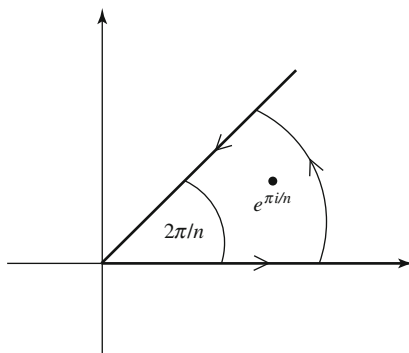

4.* Evaluate:

a. $\int_0^{\infty} \frac{\cos ax}{(x^2 + 1)^2} dx; \quad a \geq 0$

b. $\int_0^{\infty} \frac{x^2}{x^{10} + 1} dx$ (See the hint for exercise 3.)

c.

$$\int_0^{2\pi} e^{ei\theta} d\theta$$

5.* Show that

$$\int_0^{2\pi} (\cos x)^{2m} dx = \frac{2\pi}{4^m} \binom{2m}{m}$$

for any positive integer m .

6.* Show that

$$\int_{-\infty}^{\infty} \frac{dx}{(1+x^2)^{n+1}} = \frac{1 \cdot 3 \cdot 5 \cdots (2n-1)\pi}{2 \cdot 4 \cdot 6 \cdots 2n}$$

7. a. Show that $\int_{\Gamma_R} e^{iz^2} dz \rightarrow 0$ as $R \rightarrow \infty$ where Γ_R is the circular segment: $z = Re^{i\theta}$, $0 \leq \theta \leq \pi/4$.

b. Evaluate $\int_0^{\infty} \cos x^2 dx$, $\int_0^{\infty} \sin x^2 dx$. *Note:* The convergence of the above integrals can be proven for example by making the substitution $u = x^2$ and applying Dirichlet's Test.

8. Suppose f is a rational function of the form P/Q with $\deg Q - \deg P \geq 2$. Show that the sum of the residues of f is zero.

9. Evaluate

a. $\sum_{n=1}^{\infty} \frac{1}{n^2 + 1}$,

b. $\sum_{n=1}^{\infty} \frac{1}{n^4}$,

c. $\sum_{n=1}^{\infty} \frac{(-1)^n}{n^2 + 1}$.

10.* a. Show that $\int_{C_N} \frac{1}{z \sin \pi z} dz \rightarrow 0$ as $N \rightarrow \infty$, where C_N is the square with vertices $\pm(N + \frac{1}{2}) \pm (N + \frac{1}{2})i$. (See Chapter 3, exercise 16.)

b. By integrating $\frac{1}{(2z-1) \sin \pi z}$ around a suitable contour, show that $1 - \frac{1}{3} + \frac{1}{5} - \frac{1}{7} + \cdots = \frac{\pi}{4}$.

11.* Show that

$$\int_{-\infty}^{\infty} \frac{e^{kx}}{1+e^x} dx$$

converges if $0 < k < 1$. Find its value by integrating around the rectangle with vertices at $\pm R$ and at $\pm R + 2\pi i$.

12.* Suppose f is analytic for $|z| \leq 1$, and let $\log z$ be defined so that $\text{Im} \log z = \arg z \in [0, 2\pi)$. Prove

$$\text{that } \frac{1}{2\pi i} \int_{|z|=1} f(z) \log z dz = \int_0^1 f(x) dx$$

13. Evaluate

$$\sum_{n=0}^{\infty} \binom{3n}{n} \frac{1}{8^n}.$$

14. Show that

$$\sum_{n=0}^{\infty} \binom{2n}{n} x^n = \frac{1}{\sqrt{1-4x}} \text{ as long as } |x| < \frac{1}{4}.$$

Note: This is the sum of the middle column in Pascal's Triangle for powers of $1+x$.

$$\begin{array}{cccccccc}
 & & & & 1 & & & \\
 & & & & \updownarrow & & & \\
 & & & & 1 & & x & \\
 & & & & \updownarrow & & \updownarrow & \\
 & & & & 1 & & 2x & & x^2 \\
 & & & & \updownarrow & & \updownarrow & & \updownarrow \\
 & & & & 1 & & 3x & & 3x^2 & & x^3 \\
 & & & & \updownarrow & & \updownarrow & & \updownarrow & & \updownarrow \\
 & & & & 1 & & 4x & & 6x^2 & & 4x^3 & & x^4 \\
 & & & & \updownarrow & & \updownarrow & & \updownarrow & & \updownarrow & & \updownarrow \\
 & & & & \dots & & \dots & & \dots & & \dots & & \dots
 \end{array}$$

The equation can also be verified by applying the binomial expansion for $(1-4x)^{-1/2}$.

15. Complete Example 3 of Section 2-III by showing $|(z-1)^2(z+1)| \leq (16/9)\sqrt{3}$ throughout $|z|=1$.
 [Hint: Maximize a^2b given $a^2+b^2=4$.]

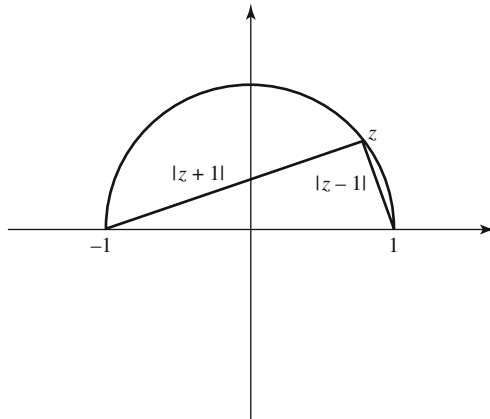

16. a. Show that

$$\left| \frac{(z-1)^2(z+1)}{z^2} \right| \leq 2\sqrt{2} \text{ for } |z| = \sqrt{2}$$

and thereby obtain an improved estimate for the example cited in (15).

b. Show that

$$\max_{|z|=R} \left| \frac{(z-1)^2(z+1)}{z^2} \right| \geq 2\sqrt{2} \text{ for any } R > 0.$$

(Thus, in a sense, the estimate in (a) is the best possible.)

17.* a. Express

$$\sum_{k=0}^n (-1)^k \binom{3n}{k} \binom{n}{k}$$

as a contour integral.

b. Use the integral above to prove that $\left| \sum_{k=0}^n (-1)^k \binom{3n}{k} \binom{n}{k} \right| \leq 4^n$.

Chapter 12

Further Contour Integral Techniques

12.1 Shifting the Contour of Integration

We have already seen how the Residue Theorem can be used to evaluate real line integrals. The techniques involved, however, are in no way limited to real integrals. To evaluate an integral along any contour, we can always switch to a more “convenient” contour as long as we account for the pertinent residues of the integrand.

EXAMPLE 1
Consider

$$\int_I \frac{e^z dz}{(z+2)^3}$$

where I is the line $z(t) = 1 + it$, $-\infty < t < \infty$.

Let C_R be the left semicircle of radius $R > 3$ centered at $z = 1$. Then

$$\int_{1-iR}^{1+iR} \frac{e^z dz}{(z+2)^3} + \int_{C_R} \frac{e^z dz}{(z+2)^3} = 2\pi i \operatorname{Res} \left(\frac{e^z}{(z+2)^3}; -2 \right).$$

Since e^z is bounded by e in the left half-plane $x \leq 1$, as $R \rightarrow \infty$

$$\int_{C_R} \frac{e^z dz}{(z+2)^3} \rightarrow 0$$

and

$$\int_I \frac{e^z dz}{(z+2)^3} = 2\pi i \operatorname{Res} \left(\frac{e^z}{(z+2)^3}; -2 \right).$$

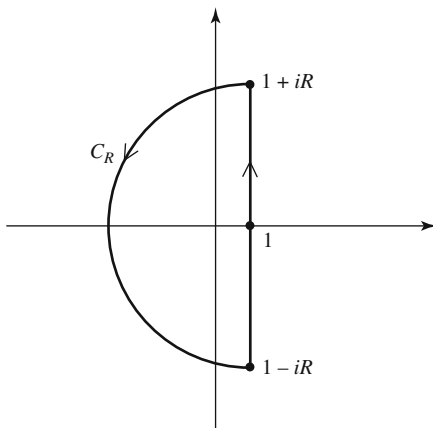

To evaluate the residue, we write

$$e^z = e^{-2}e^{z+2} = e^{-2} \left(1 + (z+2) + \frac{(z+2)^2}{2} + \dots \right)$$

so that

$$\text{Res} \left(\frac{e^z}{(z+2)^3}; -2 \right) = \frac{1}{2e^2}$$

and

$$\int_I \frac{e^z dz}{(z+2)^3} = \frac{\pi i}{e^2}.$$

◇

EXAMPLE 2

Evaluate

$$\int_{|z|=1} \frac{dz}{\sqrt{6z^2 - 5z + 1}}$$

where the square root is the positive $\sqrt{2}$ at the point $z = 1$.

Recall (see Exercise 10–16) that since $6z^2 - 5z + 1$ has its zeroes at $z = \frac{1}{2}$ and $z = \frac{1}{3}$, $\sqrt{6z^2 - 5z + 1}$ is analytic in the plane minus the interval $\frac{1}{3} \leq z \leq \frac{1}{2}$.

To evaluate the integral, we switch to the contour $|z| = R$. Then, since $\sqrt{6z^2 - 5z + 1} \sim \sqrt{6}z$ for large z , it follows that

$$\int_{|z|=R} \frac{dz}{\sqrt{6z^2 - 5z + 1}} \rightarrow \frac{1}{\sqrt{6}} \int_{|z|=R} \frac{dz}{z} = \frac{2\pi i}{\sqrt{6}}.$$

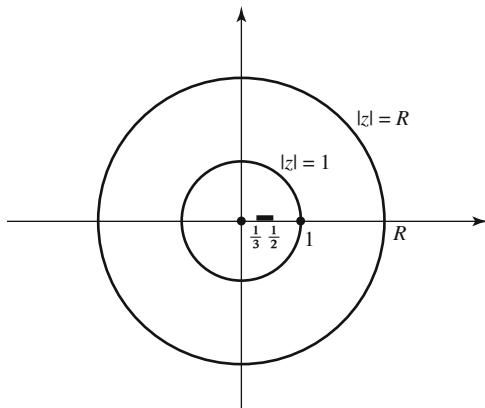

To formally justify the last step, suppose (in general) that $f(z) = z + \epsilon(z)$, where $\epsilon(z)/z \rightarrow 0$ as $z \rightarrow \infty$. Then

$$\int_{|z|=R} \frac{1}{f(z)} dz - \int_{|z|=R} \frac{dz}{z} = - \int_{|z|=R} \frac{\epsilon(z)}{z(z + \epsilon(z))} dz$$

$$\ll 2\pi \max_{|z|=R} \left| \frac{\epsilon(z)}{z + \epsilon(z)} \right| \rightarrow 0 \text{ as } R \rightarrow \infty. \quad \diamond$$

EXAMPLE 3

Based on numerical evidence, it was conjectured that

$$\sum_{k=0}^n (-1)^k \sqrt{\binom{n}{k}} \rightarrow 0 \text{ as } n \rightarrow \infty.$$

A proof of the conjecture can be given as follows:

Note that

$$f(z) = \frac{\sin \pi z}{\pi z(1-z)(1-z/2)\dots(1-z/n)}$$

satisfies

$$f(k) = \binom{n}{k} \text{ for any nonnegative integer } k.$$

Because $f(z)$ is zero-free in $-1 < \operatorname{Re} z < n + 1$, $\sqrt{f(z)}$ (taken as positive at the origin) is analytic there. By the Residue Theorem, then

$$\sum_{k=0}^n (-1)^k \sqrt{\binom{n}{k}} = \frac{1}{2\pi i} \int_C \sqrt{f(z)} \frac{\pi}{\sin \pi z} dz \tag{1}$$

where C is any contour in $-1 < \operatorname{Re} z < n + 1$ which winds *once* about each integer $0, 1, \dots, n$ and *never* about any other integer.

Suppose we let $C = C_M$ be the rectangle formed by the lines $\operatorname{Re} z = -1/2$, $\operatorname{Re} z = n + 1/2$ and $\operatorname{Im} z = \pm M$. Then

$$\int_{C_M} \sqrt{f(z)} \frac{\pi}{\sin \pi z} dz = \int_{C_M} \frac{\sqrt{\pi} dz}{\sqrt{z(1-z)(1-z/2) \dots (1-z/n) \sin \pi z}}$$

and letting $M \rightarrow \infty$, we conclude

$$\sum_{k=0}^n (-1)^k \sqrt{\binom{n}{k}} = \frac{1}{2\pi i} \left[\int_{-1/2-i\infty}^{-1/2+i\infty} + \int_{n+1/2-i\infty}^{n+1/2+i\infty} \sqrt{f(z)} \frac{\pi}{\sin \pi z} dz \right].$$

Since the integrand is invariant (aside from a \pm sign) under the substitution $z \rightarrow n-z$, we need only estimate the first integral. Now, when $\operatorname{Re} z = -\frac{1}{2}$,

$$\begin{aligned} |z(1-z)(1-z/2) \dots (1-z/n)| &\geq \frac{1}{2} \left(1 + \frac{1}{2}\right) \left(1 + \frac{1}{4}\right) \dots \left(1 + \frac{1}{2n}\right) \\ &\geq \frac{1}{2} \sqrt{1+1} \sqrt{1+\frac{1}{2}} \dots \sqrt{1+\frac{1}{n}} \\ &= \frac{\sqrt{n+1}}{2} \end{aligned}$$

and so the first integral is bounded by

$$\frac{1}{\sqrt{2\pi} \sqrt[4]{n+1}} \int_{\operatorname{Re} z = -1/2} \left| \frac{dz}{\sqrt{\sin \pi z}} \right| \leq \frac{A}{\sqrt[4]{n}}.$$

Hence

$$\sum_{k=0}^n (-1)^k \sqrt{\binom{n}{k}} \rightarrow 0 \text{ as } n \rightarrow \infty.$$

◇

12.2 An Entire Function Bounded in Every Direction

Recall that, according to Liouville's Theorem, every nonconstant entire function is unbounded. Nevertheless, one may wonder whether there is a nonconstant entire function which is bounded along every ray from the origin. The answer to this question is yes! However, there seems to be no way of describing such a function in closed form. Instead, the function will be given in integral form and the crucial estimate will then be obtained by switching the contour of integration.

The strategy is as follows: We will find a nonconstant entire function f which is bounded by 1 outside of the strip $|\operatorname{Im} z| \leq \pi$. If we consider

$$g(z) = f(z - 2\pi i),$$

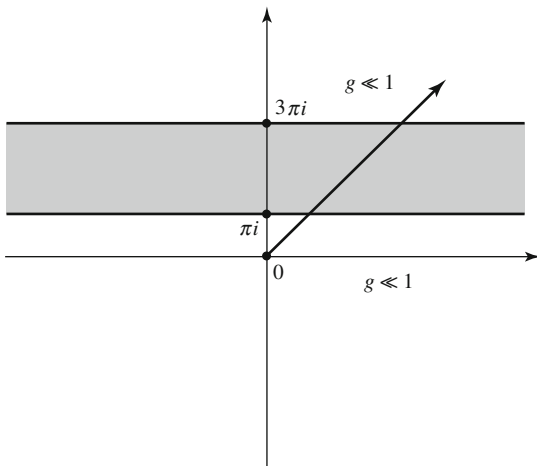

then it follows that $g \ll 1$ outside the strip $\pi \leq \text{Im } z \leq 3\pi$ and hence g will be bounded on every ray. As a final touch, we might then consider

$$h(z) = \frac{g(z) - g(0)}{z}$$

which is an entire function that approaches zero along every ray!

Construction of f : Define

$$f(z) = \int_0^\infty \frac{e^{zt}}{t^t} dt.$$

The integral converges absolutely since for any $z = x + iy$,

$$\int_0^\infty \left| \frac{e^{zt}}{t^t} \right| dt = \int_0^\infty \frac{e^{xt}}{t^t} dt < \infty.$$

Furthermore, f is continuous and for any rectangle R

$$\int_{\partial R} f(z) dz = \int_{\partial R} \left(\int_0^\infty \frac{e^{zt}}{t^t} dt \right) dz = \int_0^\infty \left(\int_{\partial R} \frac{e^{zt}}{t^t} dz \right) dt = \int_0^\infty 0 dt = 0.$$

The absolute convergence of the integral justifies the change in the order of integration. Hence, by Morera's Theorem, f is entire.

We see from our definition of f that f is real-valued along the real axis. Thus, by the Schwarz Reflection Principle, $f(\bar{z}) = \overline{f(z)}$ and we need only show that f is bounded for $z = x + iy$, $y > \pi$. In fact, we will show that for $z = x + iy$, $y = \pi/2 + c$, $|f(z)| \leq 1/c$.

To derive the stated upper bound for

$$f(z) = \int_0^\infty \frac{e^{zt}}{t^t} dt,$$

note that the integrand is an analytic function of t in the right half-plane and hence we can replace the integral

$$\int_{\epsilon}^R \frac{e^{zt}}{t^t} dt$$

along the positive axis by the integral along the quarter-circle from ϵ to $i\epsilon$ plus the integral along the imaginary axis from $i\epsilon$ to iR minus the integral along the quarter-circle C_R of radius R . (See below.) Since the integrand approaches 1 at $t = 0$, the integral along the quarter-circle of radius ϵ is negligible. As $\epsilon \rightarrow 0$ and $R \rightarrow \infty$,

$$f(z) = \int_0^{\infty} \frac{e^{zt}}{t^t} dt = - \lim_{R \rightarrow \infty} \int_{C_R} \frac{e^{zt}}{t^t} dt + \int_I \frac{e^{zt}}{t^t} dt$$

where I is the positive imaginary axis. (See the diagram below.)

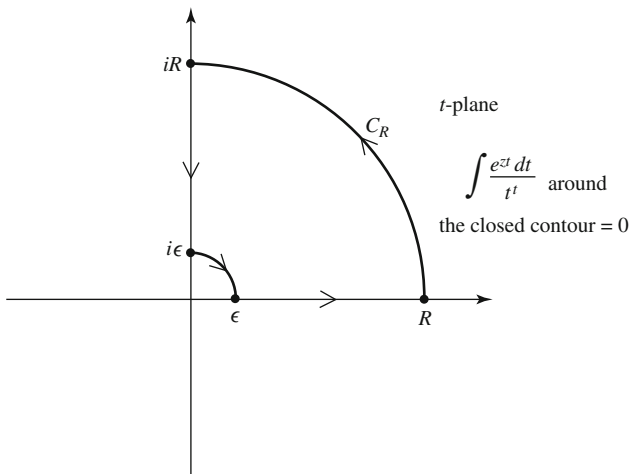

Finally we will show that the latter integral is bounded by $1/c$ and that the limit on the right is 0.

Using the obvious parametrization $t = iv$, $0 \leq v < \infty$

$$\int_I \frac{e^{zt}}{t^t} dt = i \int_0^{\infty} \frac{e^{ivz}}{(iv)^{iv}} dv \ll \int_0^{\infty} \left| \frac{e^{ivz}}{(iv)^{iv}} \right| dv$$

but for $\text{Im } z = \pi/2 + c$,

$$\left| \frac{e^{ivz}}{(iv)^{iv}} \right| = \frac{e^{-v(\pi/2+c)}}{|e^{iv \log iv}|} = \frac{e^{-v(\pi/2+c)}}{e^{-v\pi/2}} = e^{-cv}.$$

Hence

$$\int_I \frac{e^{zt}}{t^t} dt \ll \int_0^{\infty} e^{-cv} dv = \frac{1}{c}.$$

To estimate

$$\int_{C_R} \frac{e^{zt}}{t^t} dt, \quad \text{let } t = Re^{i\theta}, \quad 0 \leq \theta \leq \frac{\pi}{2}.$$

Then $\log t = \log R + i\theta$ and

$$\begin{aligned} \left| \frac{e^{zt}}{t^t} \right| &= \left| \frac{\exp[(x + iy)(R \cos \theta + iR \sin \theta)]}{\exp[(\log R + i\theta)(R \cos \theta + iR \sin \theta)]} \right| \\ &= \exp -[(\log R - x)R \cos \theta + (y - \theta)R \sin \theta]. \end{aligned}$$

Taking R large enough so that $\log R - x > y > y - \theta$,

$$\left| \frac{e^{zt}}{t^t} \right| \leq \exp -[(y - \theta)R] \leq e^{-cR}$$

and

$$\int_{C_R} \frac{e^{zt}}{t^t} dt \ll \frac{\pi}{2} R \cdot e^{-cR},$$

which approaches 0 as $R \rightarrow \infty$.

We note that for every nonconstant entire function, there is always *some* polygonal line along which the function is not only unbounded but actually approaches infinity. We prove this result in Chapter 15. (See Exercise 6.)

Exercises

1.* a. Evaluate

$$\int_I \frac{e^z}{(z+1)^4} dz,$$

where I is the imaginary axis (from $-i\infty$ to $+i\infty$).

b. Evaluate

$$\int_{1-i\infty}^{1+i\infty} \frac{a^z}{z^2} dz, \quad 0 < a < \infty.$$

2.* Evaluate

$$\int_{|z|=2} \frac{dz}{\sqrt{4z^2 - 8z + 3}}.$$

3. Evaluate $\int_\gamma e^z \log z dz$ where $\log z$ is that branch for which $\log 1 = 0$ and γ is the parabola: $\gamma(t) = 1 - t^2 + it$, $-\infty < t < \infty$.

4. Show that

$$\sum_{k=0}^n (-1)^k \binom{n}{k}^{1/3} \rightarrow 0 \quad \text{as } n \rightarrow \infty.$$

5. a. Obtain an improved estimate for

$$\sum_{k=0}^n (-1)^k \sqrt{\binom{n}{k}}$$

by integrating along the lines $\operatorname{Re} z = -3/4$ and $\operatorname{Re} z = n + 3/4$.

- b. Estimate

$$\sum_{k=0}^n (-1)^k \sqrt{\binom{n}{k}}$$

by integrating along $\operatorname{Re} z = -1 + \delta$ and $\operatorname{Re} z = n + 1 - \delta$. Find an optimal δ . [Note: Numerical evidence suggests

$$\sum_{k=0}^n (-1)^k \sqrt{\binom{n}{k}} \sim \frac{1}{\sqrt{n}} \text{ for even } n].$$

6. * Suppose g is the entire function (bounded on every ray) described in the last section. Show that $g(x + 2\pi i) \rightarrow \infty$ as $x \rightarrow \infty$.

Chapter 13

Introduction to Conformal Mapping

In this chapter, we take a closer look at the mapping properties of an analytic function. Throughout the chapter, all curves $z(t)$ are assumed to be such that $\dot{z}(t) \neq 0$ for all t .

13.1 Conformal Equivalence

13.1 Definition

Suppose two smooth curves C_1 and C_2 intersect at z_0 . Then the *angle from C_1 to C_2 at z_0* , $\angle C_1, C_2$, is defined as the angle measured counterclockwise from the tangent line of C_1 at z_0 to the tangent line of C_2 at z_0 .

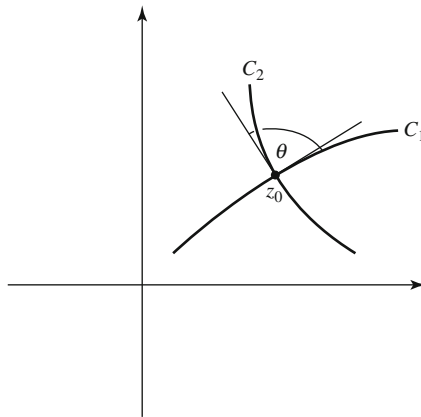

13.2 Definition

Suppose f is defined in a neighborhood of z_0 . f is said to be *conformal at z_0* if f preserves angles there. That is, for each pair of smooth curves C_1 and C_2 intersecting

at z_0 , $\angle C_1, C_2 = \angle \Gamma_1, \Gamma_2$ where $\Gamma_1 = f(C_1)$, $\Gamma_2 = f(C_2)$. Similarly, we say f is conformal in a region D if f is conformal at all points $z \in D$.

Note that $f(z) = z^2$ is *not* conformal at $z = 0$. For example, the positive real axis and the positive imaginary axis are mapped onto the positive real axis and negative real axis, respectively. However, as we shall see below, it is conformal at all other points of the complex plane.

13.3 Definition

- f is *locally* 1-1 at z_0 if for some $\delta > 0$ and any distinct $z_1, z_2 \in D(z_0; \delta)$, $f(z_1) \neq f(z_2)$.
- f is locally 1-1 throughout a region D if f is locally 1-1 at every $z \in D$.
- f is a 1-1 function in a region D , if for *every* distinct $z_1, z_2 \in D$, $f(z_1) \neq f(z_2)$.

Again, note that $f(z) = z^2$ is not locally 1-1 at $z = 0$ since $f(z) = f(-z)$ for all z . However, f is locally 1-1 at all points $z \neq 0$ (see Exercise 1).

13.4 Theorem

Suppose f is analytic at z_0 and $f'(z_0) \neq 0$. Then f is conformal and locally 1-1 at z_0 .

Proof (Conformality)

Let $C : z(t) = x(t) + iy(t)$ be a smooth curve with $z(t_0) = z_0$. Then the tangent line to C at z_0 has the direction of $\dot{z}(t_0) = x'(t_0) + iy'(t_0)$ so that its angle of inclination with the positive real axis is $\text{Arg } \dot{z}(t_0)$. If we set $\Gamma = f(C)$, then Γ is given by $\omega(t) = f(z(t))$ and the angle of inclination of its tangent line at $f(z_0)$ is equal to

$$\text{Arg } \dot{\omega}(t_0) = \text{Arg } [f'(z_0)\dot{z}(t_0)] = \text{Arg } f'(z_0) + \text{Arg } \dot{z}(t_0).$$

Hence the function f maps all curves at z_0 in such a way that the angles of inclination are increased by the constant $\text{Arg } f'(z_0)$. Thus, if C_1 and C_2 meet at z_0 and Γ_1, Γ_2 are their respective images under f , it follows that $\angle \Gamma_1, \Gamma_2 = \angle C_1, C_2$.

To show f is 1-1 in a neighborhood of z_0 , let $f(z_0) = \alpha$ and take $\delta' > 0$ small enough so that $f(z) - \alpha$ has no other zeroes in $D(z_0; \delta')$. Such a δ' can always be found for otherwise we would have $f'(z_0) = 0$ (Theorem 6.10).

If we let $C = C(z_0; \delta')$ and $\Gamma = f(C)$, it follows by the Argument Principle (10.9) that

$$\begin{aligned} 1 &= \frac{1}{2\pi i} \int_C \frac{f'(z)}{f(z) - \alpha} dz \\ &= \frac{1}{2\pi i} \int_\Gamma \frac{d\omega}{\omega - \alpha} = \frac{1}{2\pi i} \int_\Gamma \frac{d\omega}{\omega - \beta} \end{aligned}$$

for all β in some sufficiently small disc $D(\alpha; \epsilon)$, since the winding number is locally constant (see following 10.3). If we then take $\delta \leq \delta'$ so that $D(z_0; \delta) \subset f^{-1}(D(\alpha; \epsilon))$ it follows that for any $z_1, z_2 \in D(z_0; \delta)$

$$\begin{aligned} 1 &= \frac{1}{2\pi i} \int_{\Gamma} \frac{d\omega}{\omega - f(z_1)} = \frac{1}{2\pi i} \int_{\Gamma} \frac{d\omega}{\omega - f(z_2)} \\ &= \frac{1}{2\pi i} \int_C \frac{f'(z)}{f(z) - f(z_1)} dz = \frac{1}{2\pi i} \int_C \frac{f'(z)}{f(z) - f(z_2)} dz; \end{aligned}$$

i.e., the values $f(z_1)$ and $f(z_2)$ are both assumed once inside C so that $f(z_1) \neq f(z_2)$ if $z_1 \neq z_2$. \square

EXAMPLE 1

$f(z) = e^z$ has a nonzero derivative at all points, hence it is everywhere conformal and locally 1-1. (Note that it is not globally 1-1 since $f(z + 2\pi i) = f(z)$.) By the conformality of f , the images of the orthogonal lines $x = \text{constant}$ and $y = \text{constant}$ under the mapping f are themselves orthogonal. We leave it as an exercise to verify this by showing that f maps the vertical lines $x = \text{constant}$ onto circles centered at the origin and maps the horizontal lines $y = \text{constant}$ onto rays from the origin.

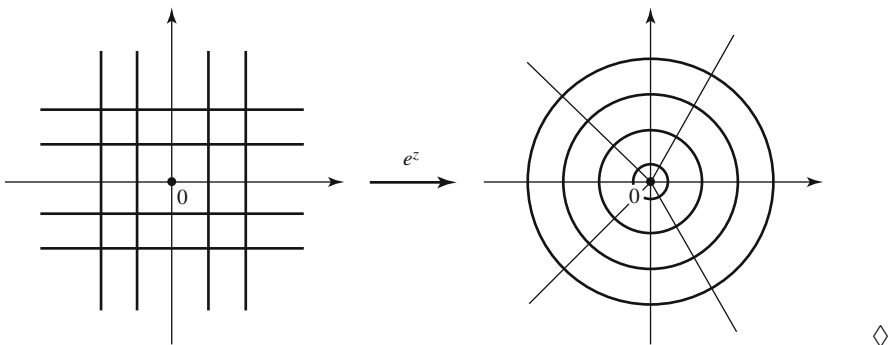

EXAMPLE 2

Let $f(z) = z^2$. Since $f'(z) = 2z \neq 0$ except at $z = 0$, f is conformal throughout $z \neq 0$. Thus, if we set $f = u + iv$, it follows that the preimages of the curves $u = c_1$, $v = c_2$ for $c_1, c_2 \neq 0$ must be orthogonal. Indeed, since $u(z) = x^2 - y^2$, $v(z) = 2xy$

these preimages are the orthogonal systems of hyperbolas given by

$$x^2 - y^2 = c_1, \quad 2xy = c_2 \quad (\text{see the figure below}).$$

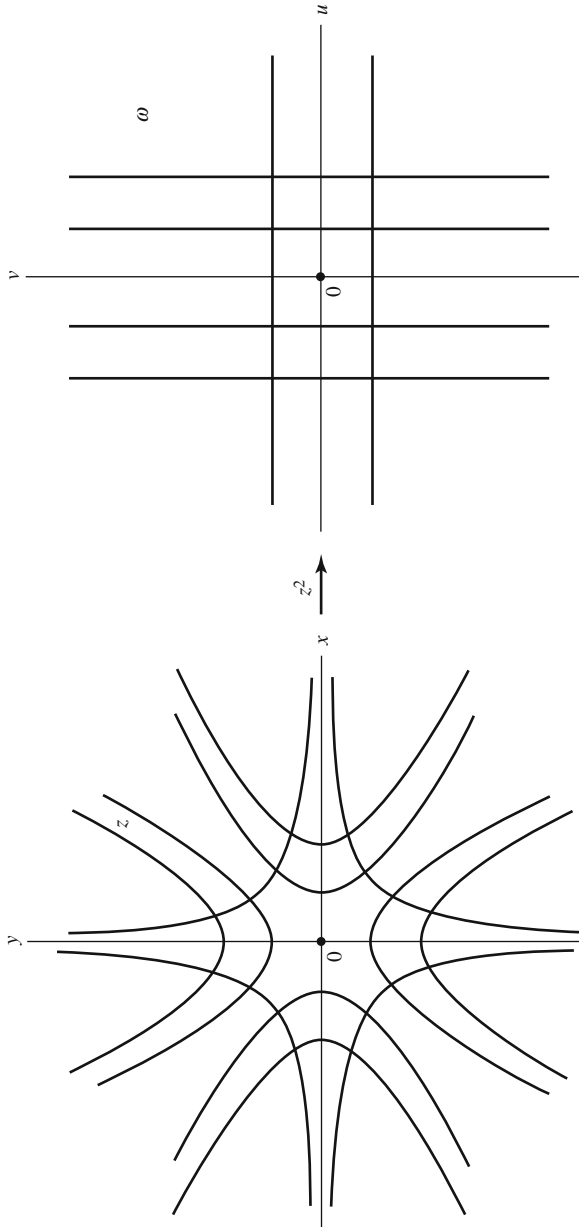

◇

To analyze the mapping properties of a function f at a point z where $f'(z) = 0$, we first consider the following special case.

13.5 Definition

Let k be a positive integer. f is a k -to-1 mapping of D_1 onto D_2 if for every $\alpha \in D_2$, the equation $f(z) = \alpha$ has k roots (counting multiplicity) in D_1 .

13.6 Lemma

Let $f(z) = z^k$, k a positive integer. Then f magnifies angles at 0 by a factor of k and maps the disc $D(0; \delta)$, $\delta > 0$, onto the disc $D(0; \delta^k)$ in a k -to-1 manner.

Proof

Since $f(re^{i\theta}) = r^k e^{ik\theta}$, f maps the ray from 0 with argument θ onto the ray from 0 with argument $k\theta$. Hence the angle at 0 between any two rays is magnified by a factor of k . To see that $f(z) = \alpha$, $\alpha \in D(0; \delta^k)$ has k roots in $D(0; \delta)$ recall that if $\alpha \neq 0$ there are k distinct roots all lying on the circle $|z| = |\alpha|^{1/k}$. If $\alpha = 0$, the equation $z^k = \alpha$ has a k -fold root at the origin. \square

We can now “complete” Theorem 13.4.

13.7 Theorem

Suppose f is analytic at z_0 with $f'(z_0) = 0$. Then, unless f is constant, in some sufficiently small open set containing z_0 , f is a k -to-1 mapping and f magnifies angles at z_0 by a factor of k , where k is the least positive integer for which $f^{(k)}(z_0) \neq 0$.

Proof

We may assume, without loss of generality, that $f(z_0) = 0$. [Otherwise, we could first consider $f(z) - f(z_0)$.] Then, by hypothesis, the power series expansion of f about z_0 is of the form

$$\begin{aligned} f(z) &= a_k(z - z_0)^k + a_{k+1}(z - z_0)^{k+1} + a_{k+2}(z - z_0)^{k+2} + \cdots \\ &= (z - z_0)^k \left[a_k + a_{k+1}(z - z_0) + a_{k+2}(z - z_0)^2 + \cdots \right] \end{aligned}$$

with $a_k = f^{(k)}(z_0)/k! \neq 0$.

If we let $g(z)$ represent the bracketed power series, we note that $g(z_0) \neq 0$ so that g has an analytic k -th root in some disc $D(z_0; \delta)$ (see the comments following Theorem 8.8). Thus, in that disc,

$$f(z) = [h(z)]^k$$

where h is an analytic function defined by

$$h(z) = (z - z_0)g^{1/k}(z)$$

and

$$h(z_0) = 0, \quad h'(z_0) = g^{1/k}(z_0) \neq 0.$$

Hence, in a sufficiently small neighborhood D of z_0 , f is the composition of the 1-1 and conformal mapping h followed by the mapping z^k . Since z^k magnifies angles at 0 by a factor of k , it follows that f magnifies angles at z_0 by k . Also, since z^k is k -to-1 on discs about 0, it follows that if

$$D(0; \epsilon) \subset h(D)$$

and

$$\eta = h^{-1}(D(0; \epsilon)),$$

then f is k -to-1 on η . □

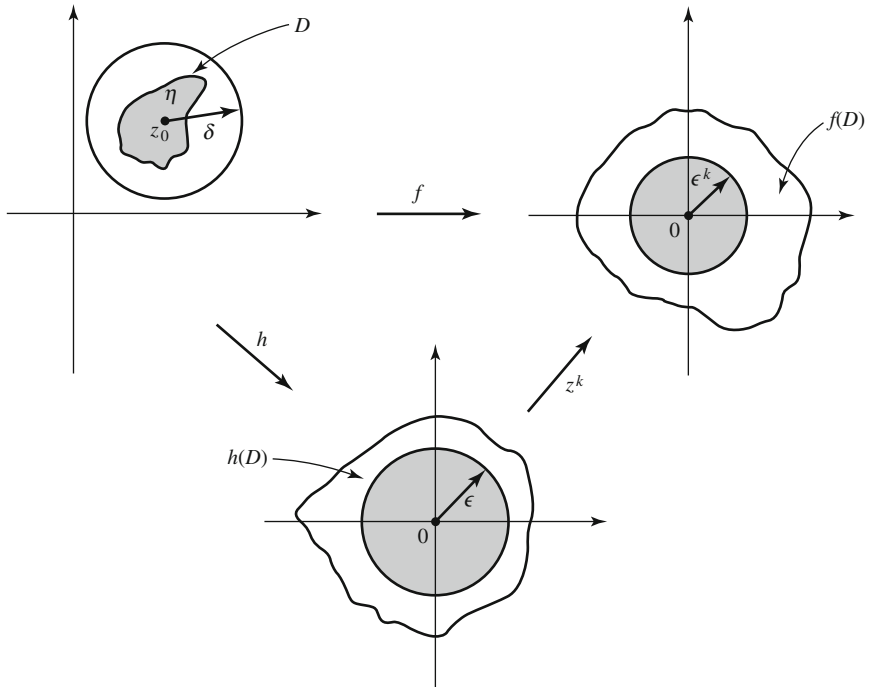

The previous results combine to yield the following properties of 1-1 analytic functions.

13.8 Theorem

Suppose f is a 1-1 analytic function in a region D . Then

- f^{-1} exists and is analytic in $f(D)$,
- f and f^{-1} are conformal in D and $f(D)$, respectively.

Proof

Since f is 1-1, $f' \neq 0$. Hence f^{-1} is also analytic (Proposition 3.5). Furthermore, $(f^{-1})' = 1/f'$ so that f^{-1} also has a nonzero derivative. Thus f and f^{-1} are both conformal. □

Theorem 13.8 motivates the following definitions:

13.9 Definitions

- a. A 1-1 analytic mapping is called a *conformal mapping*.
- b. Two regions D_1 and D_2 are said to be *conformally equivalent* if there exists a conformal mapping of D_1 onto D_2 .

We leave it as an exercise to verify that “conformal equivalence” satisfies the usual axioms of an equivalence relation. In particular, we note that the transitive property follows from the fact that the composition of two conformal mappings is also a conformal mapping, and we will use this fact throughout the remainder of the chapter.

The Riemann Mapping Theorem, which we will prove in the next chapter, asserts that any two simply connected domains (besides the whole plane) are conformally equivalent. In the next section, we will consider certain special transformations that will enable us to explicitly display conformal mappings between many familiar simply connected regions.

13.2 Special Mappings

I Elementary Transformations

(i) $\omega = az + b$.

The linear map $\omega = az + b$ is a 1-1 analytic map of the entire plane onto itself. The effect of the mapping on a given domain can be seen by viewing it as a composition $\omega = \omega_3 \circ \omega_2 \circ \omega_1$ of the mappings

1. $\omega_1 = kz, \quad k = |a|$
2. $\omega_2 = e^{i\theta}z, \quad \theta = \text{Arg } a$
3. $\omega_3 = z + b$.

A mapping of the form $\omega = kz, \quad k > 0$ is called a *magnification*. It sends each point onto another point along the same ray from the origin, multiplying its magnitude by a factor of k . The mapping $\omega = e^{i\theta}z$ is a counterclockwise *rotation* through an angle θ . Finally, $\omega = z + b$ is called a *translation* since it translates each point by the complex number, or vector, b .

(ii) $\omega = z^\alpha, \quad \alpha > 0$.

As we noted in Chapter 8, the function $\omega = z^\alpha$ given by $z^\alpha = e^{\alpha \log z}$ is analytic in every simply connected domain that does not contain 0. If we take the branch of $\log z$ which is real on the positive axis, then z^α will also map the positive axis onto itself. The point $z = re^{i\theta}$ is mapped onto $r^\alpha e^{i\alpha\theta}$ and hence $\omega = z^\alpha$ maps the wedge $S = \{z : \theta_1 < \text{Arg } z < \theta_2\}$ onto the wedge $T = \{\omega : \alpha\theta_1 < \text{Arg } \omega < \alpha\theta_2\}$. If, moreover, $\alpha\theta_2 - \alpha\theta_1 \leq 2\pi$; i.e., if $\theta_2 - \theta_1 \leq 2\pi/\alpha$, the mapping is a conformal mapping of S onto T .

Some examples are sketched below:

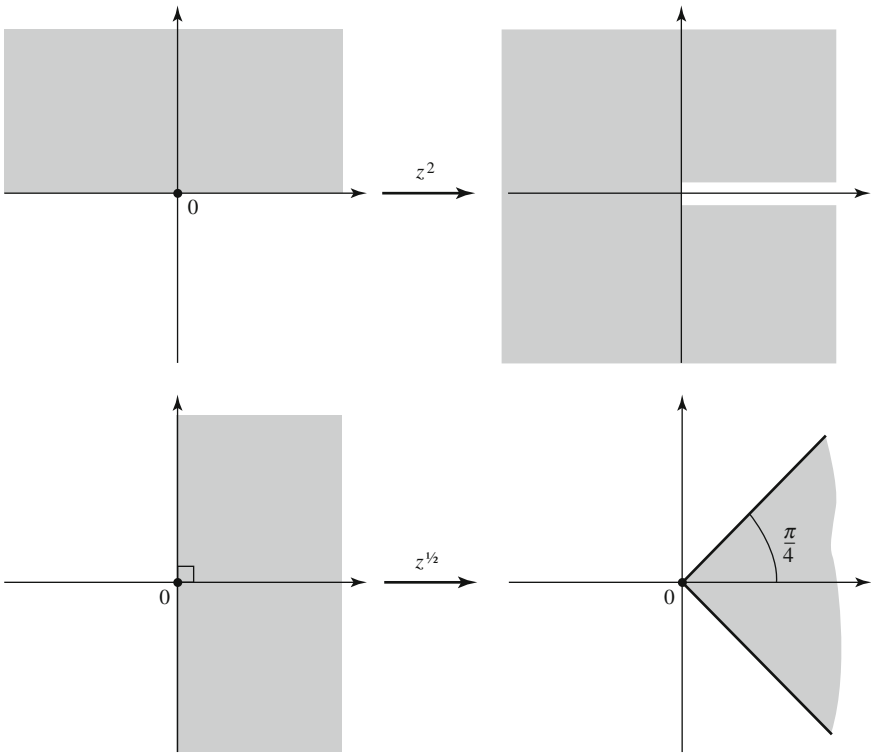

(iii) $\omega = e^z$.

Since $e^z = e^x e^{iy}$, the function $\omega = e^z$ maps the strip: $y_1 < y < y_2$ onto the wedge: $y_1 < \text{Arg } \omega < y_2$. If $y_2 - y_1 \leq 2\pi$, the mapping is 1-1. For example, the strip $0 < y < \pi$ is mapped conformally onto the upper half-plane.

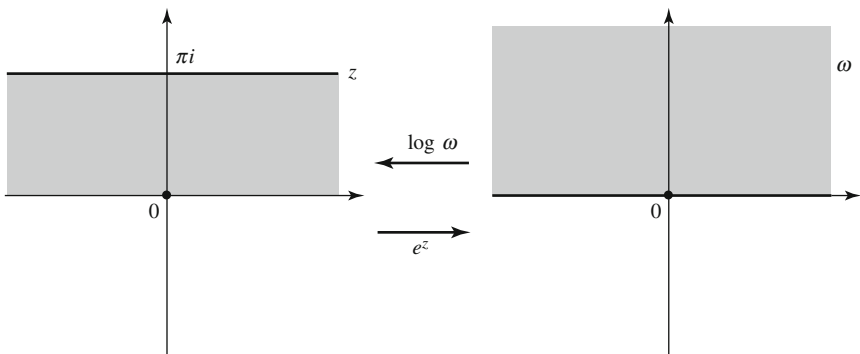

II The Bilinear Transformation $\omega = (\mathbf{az} + \mathbf{b})/(\mathbf{cz} + \mathbf{d})$

The mapping given by

$$f(z) = \frac{az + b}{cz + d}, \quad ad - bc \neq 0 \quad (1)$$

is called a bilinear transformation. The condition $ad - bc \neq 0$ insures that f is neither identically constant nor meaningless. Since

$$f'(z) = \frac{ad - bc}{(cz + d)^2} \neq 0,$$

f is locally 1-1 and conformal. In fact, a bilinear transformation is globally 1-1 since

$$\frac{az_1 + b}{cz_1 + d} = \frac{az_2 + b}{cz_2 + d}$$

implies that

$$(ad - bc)(z_1 - z_2) = 0$$

and hence that

$$z_1 = z_2.$$

The bilinear transformation (1) maps the full plane, minus the point $-d/c$, onto the full plane minus the point a/c , since the equation

$$\frac{az + b}{cz + d} = \omega$$

has the explicit solution

$$z = \frac{d\omega - b}{-c\omega + a} \quad \text{for every } \omega \neq \frac{a}{c}.$$

In fact, if we consider the limiting values $f(\infty) = (a/c)$ and $f(-d/c) = \infty$ we can say that f is a 1-1 mapping of the Riemann sphere onto itself. (See Section 1.5.)

The set of bilinear transformations forms a group under composition. It is easily seen that the inverse of a bilinear transformation is also bilinear since, as above,

$$\omega = \frac{az + b}{cz + d}$$

admits the solution

$$z = \frac{d\omega - b}{-c\omega + a}, \quad \text{and } da - (-b)(-c) = ad - bc \neq 0.$$

We leave the verification of the other group properties as an exercise.

A very useful property of bilinear transformations is that they map circles and lines onto other circles and lines. We prove this first for the special case $f(z) = 1/z$.

13.10 Lemma

If S is a circle or line, and $f(z) = 1/z$, then $f(S)$ is also a circle or line.

Proof

(A proof involving the Riemann sphere is outlined in Exercises 27 and 28 of Chapter 1. The following proof is more direct.)

Assume first that $S = C(\alpha; r)$ and let

$$f(S) = \left\{ \omega = \frac{1}{z} : z \in S \right\}.$$

Writing the equation for S in the form

$$(z - \alpha)(\bar{z} - \bar{\alpha}) = r^2$$

we have

$$z\bar{z} - \alpha\bar{z} - \bar{\alpha}z = r^2 - |\alpha|^2$$

or, in terms of ω ,

$$\frac{1}{\omega\bar{\omega}} - \frac{\alpha}{\bar{\omega}} - \frac{\bar{\alpha}}{\omega} = r^2 - |\alpha|^2. \quad (1)$$

Note then that if $r = |\alpha|$; i.e., if S passes through the origin, (1) is equivalent to

$$1 - \alpha\omega - \bar{\alpha}\bar{\omega} = 0$$

or

$$\operatorname{Re} \alpha\omega = \frac{1}{2}.$$

In that case, if $\alpha = x_0 + iy_0$ and $\omega = u + iv$, the equation for ω becomes

$$ux_0 - vy_0 = \frac{1}{2};$$

i.e., $f(S)$ is a line in the ω -plane.

If, on the other hand, $r \neq |\alpha|$, then (1) is equivalent to

$$\omega\bar{\omega} - \left(\frac{\bar{\alpha}}{|\alpha|^2 - r^2} \right) \bar{\omega} - \left(\frac{\alpha}{|\alpha|^2 - r^2} \right) \omega = \frac{-1}{|\alpha|^2 - r^2},$$

and setting

$$\beta = \frac{\bar{\alpha}}{|\alpha|^2 - r^2}$$

we obtain

$$\omega\bar{\omega} - \beta\bar{\omega} - \bar{\beta}\omega + |\beta|^2 = \frac{r^2}{(|\alpha|^2 - r^2)^2}.$$

Thus

$$|\omega - \beta|^2 = \left(\frac{r}{|\alpha|^2 - r^2} \right)^2,$$

so that $f(S)$ is a circle with center β and radius $|r/(\alpha|^2 - r^2)|$.

Finally, if S is a straight line, then there exist real-valued a , b , c such that if $z = x + iy \in S$,

$$ax + by = c. \quad (2)$$

Letting $\alpha = a - bi$, (2) is equivalent to

$$\operatorname{Re} \alpha z = c$$

or

$$\alpha z + \bar{\alpha} \bar{z} = 2c.$$

It follows then, as above, that $f(S)$ is either a circle or a line. \square

13.11 Theorem

$$f(z) = \frac{az + b}{cz + d}, \quad ad - bc \neq 0,$$

maps circles and lines onto circles and lines.

Proof

If $c = 0$, f is a linear map and the result is immediate. Otherwise, we can write

$$\frac{az + b}{cz + d} = \frac{1}{c} \left[\frac{acz + ad - ad + bc}{cz + d} \right] = \frac{1}{c} \left[a - \left(\frac{ad - bc}{cz + d} \right) \right].$$

Thus f is the composition $f = f_3 \circ f_2 \circ f_1$, where

$$f_1(z) = cz + d,$$

$$f_2(z) = \frac{1}{z},$$

$$f_3(z) = \frac{a}{c} - \left(\frac{ad - bc}{c} \right) z.$$

f_1 and f_3 are linear; hence they map circles and lines into circles and lines. By Lemma 13.10, the same is true for f_2 , and thus it follows that f has the desired property. \square

The above properties of bilinear transformations make them a very handy tool in solving many conformal mapping and miscellaneous geometric problems.

EXAMPLE 1

Find a conformal mapping f of the semi-disc $S = \{z : |z| < 1, \operatorname{Im} z > 0\}$ onto the upper half-plane.

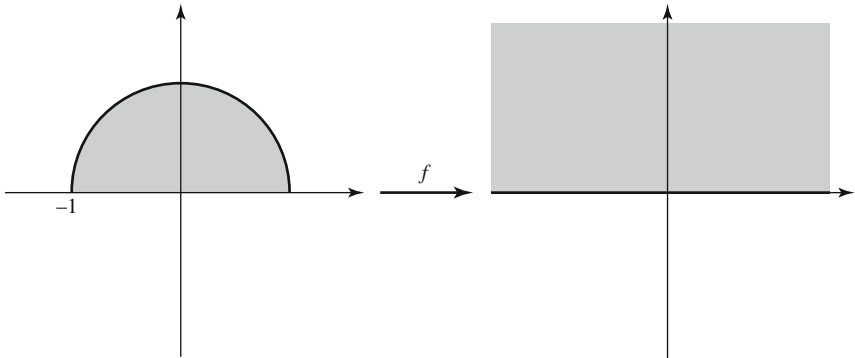

Note that because $g(z) = 1/(z + 1)$ has a pole at -1 , it maps the line segment $[-1, 1]$ and the upper semi-circle onto infinite rays. Furthermore, the two rays must intersect at $g(1) = \frac{1}{2}$, and by the conformality of g , they intersect orthogonally. By considering several points, it can then be seen that g maps the segments onto the lines indicated below and maps the semi-disc onto the quadrant bounded by the orthogonal rays.

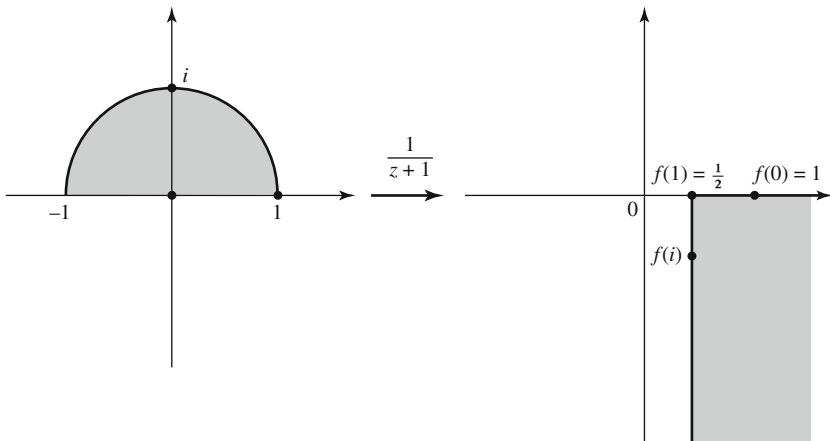

Thus, the desired mapping f is given by

$$f(z) = \left[i \left(g(z) - \frac{1}{2} \right) \right]^2 = \frac{-(z-1)^2}{4(z+1)^2}.$$

◇

EXAMPLE 2

Suppose two circles C_1 and C_2 are tangent at a point α and a chain of circles tangent to C_1 and C_2 and to each other is constructed as indicated. Prove that the points of tangency a, b, c, \dots thus created all lie on a circle.

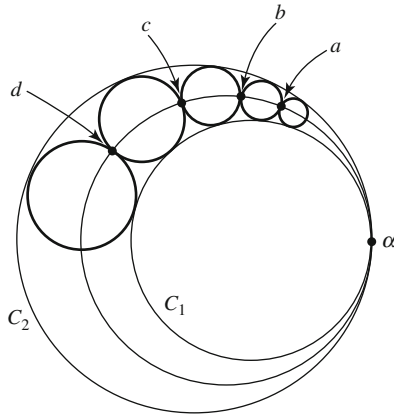

Consider the image of the above diagram under the mapping $f(z) = 1/(z - \alpha)$. Since the mapping is 1-1 and has a pole at α , C_1 and C_2 are mapped into a pair of parallel lines. Furthermore, all the other circles are mapped into circles and, again since f is 1-1, the circles will be tangent to the parallel lines and to each other.

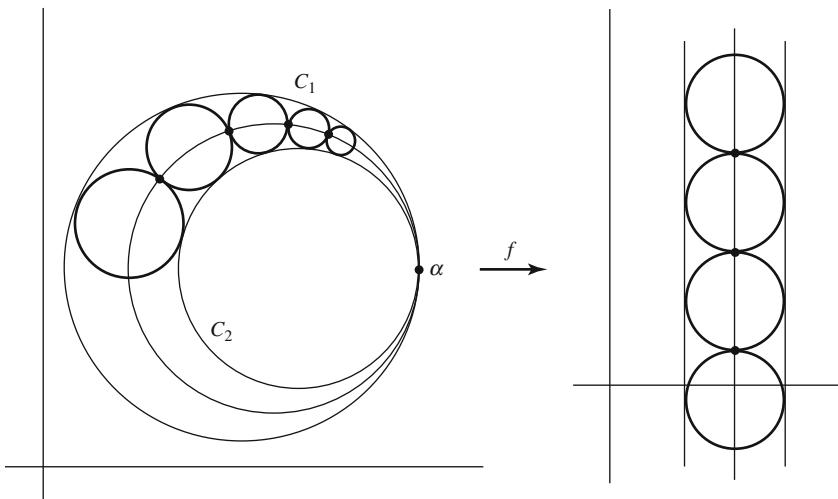

It is clear that the points $f(a), f(b), f(c), \dots$ lie on a straight line (between $f(C_1)$ and $f(C_2)$). Finally, then, a, b, c, \dots all lie on the image of this line under the inverse transformation f^{-1} . Since f^{-1} is also bilinear, this image is a circle and the result is established. \diamond

In light of Theorem 13.11, it will come as no surprise that bilinear functions can be used to map half-planes and discs conformally onto other half-planes and discs. In fact, as we shall see below, all such mappings are given by bilinear transformations.

13.12 Definition

A conformal mapping of a region onto itself is called an *automorphism* of that region.

13.13 Lemma

Suppose $f: D_1 \rightarrow D_2$ is a conformal mapping. Then

- any other conformal mapping $h: D_1 \rightarrow D_2$ is of the form $g \circ f$;
- any automorphism h of D_1 is of the form $f^{-1} \circ g \circ f$, where g is an automorphism of D_2 .

Proof

- If f and h are both conformal mappings of D_1 onto D_2 , then $h \circ f^{-1}$ is an automorphism of D_2 ; i.e., $h \circ f^{-1} = g$ and $h = g \circ f$.
- If h is an automorphism of D_1 , $f \circ h \circ f^{-1}$ is an automorphism of D_2 ; thus $f \circ h \circ f^{-1} = g$ and $h = f^{-1} \circ g \circ f$. \square

We now consider the problem of determining all the automorphisms of the unit disc.

13.14 Lemma

The only automorphisms of the unit disc with $f(0) = 0$ are given by $f(z) = e^{i\theta}z$.

Proof

If f maps the unit disc 1-1 onto itself and $f(0) = 0$, then by Schwarz' Lemma (7.2)

$$|f(z)| \leq |z| \quad \text{for } |z| < 1. \quad (3)$$

Moreover, since f^{-1} also maps the disc onto itself and $f^{-1}(0) = 0$, by the same argument,

$$|f^{-1}(z)| \leq |z| \quad \text{for } |z| < 1. \quad (4)$$

However, (3) and (4) can both be valid only if $|f(z)| = |z|$ and, by Schwarz' Lemma once again, it follows that

$$f(z) = e^{i\theta}z. \quad \square$$

Suppose now that we wish to find an automorphism f of the unit disc with $f(\alpha) = 0$, for a fixed α , $0 < |\alpha| < 1$. If we assume that f is bilinear, then since f is globally 1-1, it must map the unit circle onto itself and we can thus apply the Schwarz Reflection Principle (7.8) (see also Exercise 19, Chapter 7) to conclude that

$f(1/\bar{\alpha}) = \infty$. Hence f must be of the form

$$f(z) = c \left(\frac{z - \alpha}{z - 1/\bar{\alpha}} \right).$$

Setting

$$|f(1)| = |c\alpha| = 1$$

we have $|c| = (1/|\alpha|)$, and f may be written in the form

$$f(z) = e^{i\theta} \left(\frac{z - \alpha}{1 - \bar{\alpha}z} \right).$$

This suggests the following theorem.

13.15 Theorem

The automorphisms of the unit disc are of the form

$$g(z) = e^{i\theta} \left(\frac{z - \alpha}{1 - \bar{\alpha}z} \right), \quad |\alpha| < 1.$$

Proof

Let $g(z) = (z - \alpha)/(1 - \bar{\alpha}z)$. Then, as we noted previously (following 7.2), $|g(z)| = 1$ for $|z| = 1$. Since $g(\alpha) = 0$, it follows that g is indeed an automorphism of the unit disc. Now assume that f is an automorphism of the unit disc with $f(\alpha) = 0$. Then $h = f \circ g^{-1}$ is an automorphism with $h(0) = 0$, so that according to the previous lemma

$$h(z) = e^{i\theta} z$$

or

$$f(z) = e^{i\theta} \left(\frac{z - \alpha}{1 - \bar{\alpha}z} \right).$$

□

Suppose next that we wish to determine a conformal mapping h of the upper half-plane onto the unit disc. Again, let us first assume that h is bilinear and $h(\alpha) = 0$, for fixed α with $\text{Im } \alpha > 0$. Then, since the real axis is mapped into the unit circle, it follows by the Schwarz Reflection Principle that $h(\bar{\alpha}) = \infty$ so that

$$h(z) = c \left(\frac{z - \alpha}{z - \bar{\alpha}} \right).$$

13.16 Theorem

The conformal mappings h of the upper half-plane onto the unit disc are of the form

$$h(z) = e^{i\theta} \left(\frac{z - \alpha}{z - \bar{\alpha}} \right), \quad \text{Im } \alpha > 0.$$

Proof

Let $f(z) = (z - \alpha)/(z - \bar{\alpha})$. Since $|z - \alpha| = |z - \bar{\alpha}|$ for real z , f maps the real axis onto the unit circle. Also, since $f(\alpha) = 0$ and $\text{Im } \alpha > 0$, it follows that f maps the upper half-plane onto the unit disc. Suppose then that h is any conformal mapping of the upper half-plane onto the unit disc and $h(\alpha) = 0$. By Lemma 13.13, h is of the form

$$h = g \circ f$$

where g is an automorphism of the disc. However, since $h(\alpha) = g(0) = 0$, it follows that $g(z) = e^{i\theta} z$ (13.14) and

$$h(z) = e^{i\theta} \left(\frac{z - \alpha}{z - \bar{\alpha}} \right).$$

□

13.17 Theorem

The automorphisms of the upper half-plane are of the form

$$h(z) = \frac{az + b}{cz + d}$$

with a, b, c, d real and $ad - bc > 0$.

Proof

Let h be as above. Then clearly h maps the real axis onto itself. Also,

$$\text{Im } f(i) = \frac{ad - bc}{c^2 + d^2} > 0,$$

so that i is mapped into the upper half-plane and hence f is an automorphism of the upper half-plane. To show that there are no other automorphisms, we can apply Lemma 13.13 and Theorem 13.15 to show that any such automorphism h must be of the form $h = f^{-1} \circ g \circ f$ with

$$f(z) = \frac{z - i}{z + i} \quad \text{and} \quad g(z) = e^{i\theta} \left(\frac{z - \alpha}{1 - \bar{\alpha}z} \right), \quad |\alpha| < 1.$$

We leave it as an exercise to verify that such a mapping can be written in the form

$$h(z) = \frac{az + b}{cz + d}; \quad a, b, c, d, \text{ real}; \quad ad - bc > 0.$$

(See Exercise 16.)

□

In the results that follow, we will see that there is a unique bilinear mapping sending any three distinct points z_1, z_2, z_3 onto any three distinct points $\omega_1, \omega_2, \omega_3$, respectively.

13.18 Definition

z_0 is called a *fixed point* of the function f if $f(z_0) = z_0$.

13.19 Proposition

A bilinear transformation (other than the identity mapping $f(z) = z$) has at most two fixed points.

Proof

Let $f(z) = (az + b)/(cz + d)$. If $c \neq 0$, the equation $f(z) = z$ is equivalent to the quadratic equation $az + b = cz^2 + dz$ and hence has at most two solutions. (Note also that in this case $f(\infty) = a/c \neq \infty$.) If $c = 0$, f is linear and, unless $a/d = 1$, $f(z) = z$ has one solution in the finite complex plane. In this case, since $f(\infty) = \infty$, the point at infinity may be considered a second fixed point. Finally, if $f(z) = z + b$, there are no fixed points in \mathbb{C} . \square

13.20 Lemma

The unique bilinear mapping sending z_1, z_2, z_3 into $\infty, 0, 1$, respectively, is given by

$$T(z) = \frac{(z - z_2)(z_3 - z_1)}{(z - z_1)(z_3 - z_2)}.$$

Proof

Certainly T has the desired properties. If S is another bilinear transformation which maps z_1, z_2, z_3 into $\infty, 0, 1$, then $T \circ S^{-1}$ is a bilinear map with three fixed points, so that $T \circ S^{-1}$ is the identity map and $T \equiv S$. \square

Note that the lemma, with the appropriate modifications, is valid also if some $z_i = \infty$. If $z_1 = \infty$, the map is given by

$$T(z) = \frac{z - z_2}{z_3 - z_2}.$$

If $z_2 = \infty$,

$$T(z) = \frac{z_3 - z_1}{z - z_1};$$

and if $z_3 = \infty$,

$$T(z) = \frac{z - z_2}{z - z_1}.$$

13.21 Definition

The *cross-ratio* of the four complex numbers z_1, z_2, z_3, z_4 —denoted (z_1, z_2, z_3, z_4) —is the image of z_4 under the bilinear map which maps z_1, z_2, z_3 into $\infty, 0, 1$, respectively.

By the preceding lemma

$$(z_1, z_2, z_3, z_4) = \left(\frac{z_4 - z_2}{z_4 - z_1} \right) \left(\frac{z_3 - z_1}{z_3 - z_2} \right).$$

13.22 Proposition

The cross-ratio of four points is invariant under bilinear transformations: i.e., if S is bilinear, $(Sz_1, Sz_2, Sz_3, Sz_4) = (z_1, z_2, z_3, z_4)$.

Proof [Ahlfors]

Let T be the bilinear map which sends z_1, z_2, z_3 into $\infty, 0, 1$. Then $T \circ S^{-1}$ maps Sz_1, Sz_2, Sz_3 into $\infty, 0, 1$ and by definition $(Sz_1, Sz_2, Sz_3, Sz_4) = T \circ S^{-1}(Sz_4) = Tz_4 = (z_1, z_2, z_3, z_4)$. \square

13.23 Theorem

The unique bilinear transformation $\omega = f(z)$ mapping z_1, z_2, z_3 into $\omega_1, \omega_2, \omega_3$, respectively, is given by

$$\frac{(\omega - \omega_2)(\omega_3 - \omega_1)}{(\omega - \omega_1)(\omega_3 - \omega_2)} = \frac{(z - z_2)(z_3 - z_1)}{(z - z_1)(z_3 - z_2)}. \quad (5)$$

Proof

The existence of the mapping f is easily established. If we let T_1, T_2 be the bilinear maps with

$$T_1 : z_1, z_2, z_3 \rightarrow \infty, 0, 1$$

$$T_2 : \omega_1, \omega_2, \omega_3 \rightarrow \infty, 0, 1$$

then $f = T_2^{-1} \circ T_1$. To show that $\omega = f(z)$ must satisfy (5), we need only invoke Proposition 13.22 that the cross-ratio of any four points is preserved under a bilinear map and hence

$$(\omega_1, \omega_2, \omega_3, \omega) = (z_1, z_2, z_3, z).$$

(The appropriate modification of (5) if some z_i or some $\omega_i = \infty$ is left as an exercise.) \square

Note that (5) affords a direct method to find the desired mapping by simply solving for ω .

EXAMPLE

To map $z_1 = 1, z_2 = 2, z_3 = 7$ onto $\omega_1 = 1, \omega_2 = 2, \omega_3 = 3$ we set

$$\frac{(\omega - 2)(3 - 1)}{(\omega - 1)(3 - 2)} = \frac{(z - 2)(7 - 1)}{(z - 1)(7 - 2)}$$

or, solving for ω ,

$$\omega = \frac{7z - 4}{2z + 1}.$$

\diamond

13.3 Schwarz-Christoffel Transformations

I Mapping a Semi-Infinite Strip Onto a Half-Plane

We will show that $f(z) = \sin z$ maps the semi-infinite strip:

$$\frac{-\pi}{2} < \operatorname{Re} z < \frac{\pi}{2}; \operatorname{Im} z > 0$$

conformally onto the upper half-plane by considering its behavior on the rectangle R :

$$\frac{-\pi}{2} \leq \operatorname{Re} z \leq \frac{\pi}{2}; 0 \leq \operatorname{Im} z \leq N$$

for large N .

Of course, the interval $[\frac{-\pi}{2}, \frac{\pi}{2}]$ is mapped onto $[-1, 1]$. For complex z , we use the identity

$$\sin z = \sin(x + iy) = \sin x \cosh y + i \cos x \sinh y \quad (1)$$

to show that $\sin(\frac{\pi}{2} + iy) = \cosh y$, which is real-valued and increases from 1 to $\cosh N$ as y increases from 0 to N . Note that the mapping $f(z) = \sin z$ doubles the vertex angle of R at $z = \frac{\pi}{2}$, as we could have anticipated since $f'(z)$ has a simple zero at that point.

Along the line $\operatorname{Im} z = N$,

$$\sin z = \sin x \cosh N + i \cos x \sinh N \quad (2)$$

For large N , $\sinh N$ is just slightly smaller than $\cosh N$ since both are very close to $\frac{1}{2}e^N$. Hence, according to (2), as x varies from $\frac{\pi}{2}$ to $\frac{-\pi}{2}$, $\sin z$ traces an "almost circular" elliptical path from $\cosh N$ counterclockwise to $-\cosh N$.

Finally, $\sin z$ maps the interval connecting $\frac{-\pi}{2} + iN$ to $\frac{-\pi}{2}$ onto the interval $[-\cosh N, -1]$. So $\sin z$ maps the boundary of R onto the boundary of a region S whose base is the real interval $[-\cosh N, \cosh N]$ and which is very close to a semicircular region in the upper half-plane. By the Argument Principle, then, f maps the interior of R onto the interior of S (see Remark 2 following Corollary 10.9).

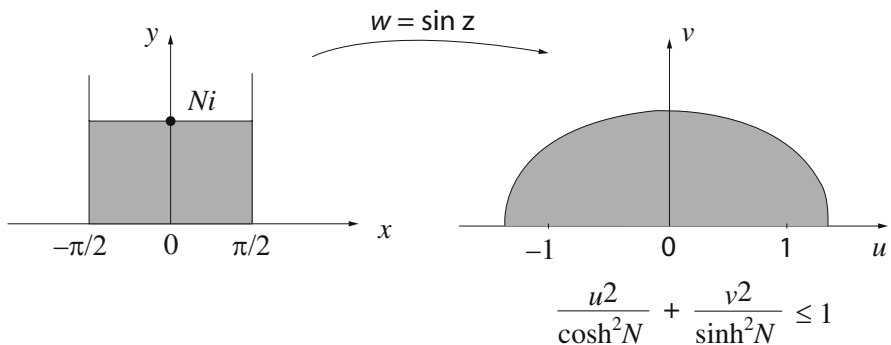

It follows, letting $N \rightarrow \infty$, that $\sin z$ maps the semi-infinite strip:

$$\frac{-\pi}{2} < \operatorname{Re} z < \frac{\pi}{2}; \operatorname{Im} z > 0$$

conformally onto the upper half-plane. \square

A mapping of any other semi-infinite strip onto a half-plane or onto any of the domains previously considered can be found by composing $\sin z$ with the appropriate conformal mappings.

It is interesting to examine the inverse function, $\sin^{-1} z$, which can be defined by the familiar integral formula:

$$\sin^{-1} z = \int_0^z \frac{1}{\sqrt{1-\zeta^2}} d\zeta$$

Unlike $\sin z$, which is an entire function, $\sin^{-1} z$ is not analytic at the points $z = \pm 1$. This follows immediately from the fact that its derivative, $\frac{1}{\sqrt{1-z^2}}$, approaches ∞ as $z \rightarrow \pm 1$. It is also evident geometrically since $\sin^{-1} z$ maps the straight angles at $z = \pm 1$ onto right angles. The function $\sin^{-1} z$ is analytic, however, as is $\frac{1}{\sqrt{1-z^2}}$, in the plane slit along the two rays $z = \pm 1 - iy$, $0 \leq y < \infty$. In particular, it is analytic in the upper half-plane and continuous to the boundary, including the points ± 1 , since the improper definite integral $\int_0^1 \frac{1}{\sqrt{1-x^2}} dx$ converges to $\pi/2$. As was the case with $\sin z$, it is easy to determine the behavior of $\sin^{-1} z$ along the boundary; i.e., along the x -axis.

To that end, note that its derivative:

$$\frac{d}{dz} \sin^{-1} z = \frac{1}{\sqrt{1-z^2}}$$

is positive on the interval $-1 < z < 1$. So $\sin^{-1} z$ maps the closed interval $[-1, 1]$ monotonically onto the interval $[-\frac{\pi}{2}, \frac{\pi}{2}]$. To see how the analytic $\frac{1}{\sqrt{1-z^2}}$ behaves on the remainder of the line, consider $\sqrt{1+z}$ as z varies along a small semicircular arc from $-1+r$ to $-1-r$. That is, let $z = -1 + re^{i\theta}$, $0 \leq \theta \leq \pi$. Then

$$\sqrt{1+z} = \sqrt{re^{i\theta}} = \sqrt{r}e^{i\theta/2}$$

and at $z = -1 - r$, i.e. when $\theta = \pi$, $\sqrt{1+z}$ is a multiple of i . It follows that $\frac{1}{\sqrt{1+z}}$ and $\frac{1}{\sqrt{1-z^2}}$ are negative multiples of i throughout the interval $(-\infty, -1)$. This property of its derivative, and the fact that $\int_{-\infty}^{-1} \frac{1}{\sqrt{1-\zeta^2}} d\zeta$ diverges, show that $\sin^{-1} z$ maps $(-\infty, -1)$ onto the ray from $-\pi/2 + i\infty$ to $-\pi/2$. By analyzing $\sqrt{1-z}$ in a semicircular arc around $z = 1$, we can see that $\sin^{-1} z$ maps the interval $(1, \infty)$ onto the ray from $\pi/2$ to $\pi/2 + i\infty$. (This also follows from the Schwarz Reflection

Principle (7.9) since $\frac{1}{\sqrt{1-z^2}}$ is real-valued on the imaginary axis, so that $\sin^{-1} z$ maps the imaginary axis into itself.)

While our insights into the mapping properties of $\sin z$ were very dependent on formula (1), our analysis of the behavior of $\sin^{-1} z$ along the real line can easily be adapted to a wide range of problems. This will ultimately lead to the general Schwarz-Christoffel formula, but first we consider the following special case:

II Mapping the Upper Half-Plane Onto a Rectangle.

As we saw in the last section, if the argument of $f'(z)$ is constant along a straight line, $f(z)$ will map that line into another line. To be specific, recall that

$$f(z) - f(z_0) = \int_{z_0}^z f'(\zeta) d\zeta$$

Hence if γ represents the ray: $z = z_0 + re^{i\alpha}$, $r > 0$, and if $\text{Arg}(f') = \beta$, then $\Gamma = f(\gamma)$ will travel along the ray

$$\omega = f(z_0) + se^{i(\alpha+\beta)}, s > 0$$

More specifically, if z travels to the right along the real axis from a real point z_0 , and if f' has a constant argument of θ , then $f(z)$ will travel along the ray from $f(z_0)$ with argument θ .

If we want to find a function f which maps the upper half-plane onto a rectangle, we would like f to map the real line onto the four sides of the rectangle. This suggests that f' should have exactly four different arguments on the segments of the real line and that its argument should increase by $\frac{\pi}{2}$ as we move (to the right) from one segment to the next. To create such a function f' , note that if z_0 represents any real number, $z - z_0$ has a constant argument of π for real $z < z_0$, and a constant argument of 0 for real $z > z_0$. If we define the analytic function $(z - z_0)^{-\alpha}$ so that it is positive for real $z > z_0$, its argument will increase from $-\alpha\pi$ to 0 as z crosses the point z_0 . In particular, with $\alpha = 1/2$, the argument of $(z - z_0)^{-\alpha}$ increases by $\pi/2$ as z crosses over the point z_0 . So, to define f' , we can pick four arbitrary real numbers $a < b < c < d$ and let

$$f'(z) = 1/\sqrt{(z-a)(z-b)(z-c)(z-d)}.$$

The square root in the denominator is defined as the product of the square roots of each of its linear factors, and each of these is defined to be positive for large positive values of z . We can then define

$$f(z) = \int_0^z f'(\zeta) d\zeta = \int_0^z \frac{1}{\sqrt{(\zeta-a)(\zeta-b)(\zeta-c)(\zeta-d)}} d\zeta \quad (3)$$

Note that although $f'(z)$ is undefined at the (real) points a, b, c, d , it is analytic in the entire complex plane slit along the four rays from t to $t - i\infty$, for

$t = a, b, c, d$. So it is analytic on the closed upper half-plane minus the points a, b, c, d . Technically, the path of integration in (3) should be indented slightly to avoid these points. However, since the associated improper integrals are all convergent, the path of integration can be along the real line for all real z , including $z = a, b, c, d$, and f is continuous at all points of the real line. Moreover, since the real integral

$$\int_d^{\infty} \frac{1}{\sqrt{(x-a)(x-b)(x-c)(x-d)}} dx$$

converges, $\lim_{z \rightarrow \infty} f(z)$ exists, as does $\lim_{z \rightarrow -\infty} f(z)$.

According to our earlier remarks, f maps the interval $(-\infty, a]$ onto a finite interval parallel to the real line, and it maps the four successive intervals: $[a, b], [b, c], [c, d], [d, \infty)$ onto intervals, each of which represents a counterclockwise rotation of $\pi/2$ from its predecessor. These facts alone do not guarantee that the image of the real line is the boundary of a rectangle. It does follow, however, once we can show that $f(-\infty) = f(\infty)$; i.e., that

$$\int_{-\infty}^{\infty} \frac{1}{\sqrt{(x-a)(x-b)(x-c)(x-d)}} dx = 0 \quad (4)$$

This follows by the type of argument used in Chapter 11. Let C_R be the closed contour consisting of the real interval $[-R, R]$ followed by Γ_R , the upper semicircle of radius R , traversed counterclockwise from R to $-R$, and let $C_{R,\varepsilon}$ be the contour formed by replacing each interval in C_R of the form $[t - \varepsilon, t + \varepsilon]$, $t = a, b, c, d$ with a semicircle in the upper half-plane centered at t , with radius ε . By the Cauchy Closed Curve Theorem,

$$\int_{C_{R,\varepsilon}} f'(\zeta) d\zeta = 0$$

and, letting $\varepsilon \rightarrow 0$, we see that

$$\int_{C_R} f'(\zeta) d\zeta = 0$$

That is,

$$\int_{-R}^R \frac{1}{\sqrt{(x-a)(x-b)(x-c)(x-d)}} dx + \int_{\Gamma_R} f'(\zeta) d\zeta = 0$$

Since $|f'(z)|$ is asymptotic to $1/R^2$ throughout Γ_R , the usual $M - L$ estimate shows that the second integral above approaches 0 as $R \rightarrow \infty$, thus proving equation (4).

An analogous argument can be used to show that f maps the upper half-plane conformally onto the inside of the rectangle. We need only note that for any point ω inside the rectangle, if R is sufficiently large, f maps C_R onto a contour which is

just a slight perturbation of the boundary of the rectangle and hence winds around the point ω exactly once. By the Argument Principle, f takes the value ω exactly once inside C_R . The general result follows by letting $R \rightarrow \infty$. \square

It is interesting that we never directly established that the definite integrals which yield the lengths of opposite sides of the rectangle have the same magnitude. In fact, if it weren't an obvious corollary of our other arguments, it would be hard to verify directly. For example, if we let a, b, c, d equal 1, 2, 5, 9, respectively, it follows that

$$\int_1^2 \frac{1}{\sqrt{(x-1)(2-x)(5-x)(9-x)}} dx = \int_5^9 \frac{1}{\sqrt{(x-1)(x-2)(x-5)(9-x)}} dx$$

One particularly nice choice for a, b, c, d is the set of values $-1/k, -1, 1, 1/k$ with $k < 1$. The resulting formula for $f(z)$ given by (3), and with a suitable additional constant factor, is

$$f(z) = \int_0^z \frac{1}{\sqrt{(1-\zeta^2)(1-k^2\zeta^2)}} d\zeta$$

This is known as an elliptic integral of the first kind. In this form it is easy to verify directly that opposite sides of the rectangle obtained have equal length. It is also easy to show that by choosing an appropriate value of k , the rectangle obtained can have adjacent sides of any desired ratio.

Note also that if we omitted the fourth point d in formula (3), the resulting function

$$f(z) = \int_0^z f'(\zeta) d\zeta = \int_0^z \frac{1}{\sqrt{(\zeta-a)(\zeta-b)(\zeta-c)}} d\zeta$$

would still map the (closed) upper half-plane, with the point at ∞ , onto a closed rectangle. This follows from the behavior of $f(z)$ along the real axis and from the fact that in this case, as in formula (3), $f(-\infty) = f(\infty)$. Here, the point at infinity takes the place of the "missing" point d , and is mapped by f onto one of the vertices of the rectangle.

III Mapping the Upper Half Plane Onto any Convex Polygon

The ideas of the previous section are easily generalized to find a conformal mapping f of the upper half-plane onto a convex polygon with any number of sides and any interior angles. To assure that f maps the real line (with the point at infinity) onto the boundary of such a polygon, we choose n real points $a_1 < a_2 < \dots < a_n$, and define

$$f'(z) = (z - a_1)^{-\alpha_1} (z - a_2)^{-\alpha_2} \dots (z - a_n)^{-\alpha_n}$$

where the n exterior angles of the polygon are equal in order to $\alpha_1\pi, \alpha_2\pi, \dots, \alpha_n\pi$. As in the previous section, each of the analytic functions $(z - a_i)^{-\alpha_i}$ is defined so that its argument is 0 for real $z > a_i$ and $-\alpha_i\pi$ for real $z < a_i$. Since the desired image

polygon is convex, $0 < \alpha_i < 1$ for each i , and $\sum \alpha_i = 2$. So if we once again define $f(z) = \int_0^z f'(\zeta) d\zeta$, it follows that the argument of f' increases by $\alpha_i \pi$, and f has a corresponding change in direction, as z crosses the real point a_i . Moreover, by the same reasoning used in the previous section, $\lim_{z \rightarrow \infty} f(z)$ and $\lim_{z \rightarrow -\infty} f(z)$ both exist and are equal. Taken together, these properties assure that f is a conformal mapping of the upper half-plane onto a polygon of the desired type.

Here, too, if we omitted the final factor: $(z - a_n)^{\alpha_n}$ from the formula for f , it would still map the upper half-plane onto a polygon of the desired type. As in the case of the rectangle, the point at ∞ would map into one of the n vertices of the polygon.

In this general setting, it is more difficult to show that, with the proper choices of a_1, a_2, \dots, a_n , the function f can be made to map the upper half-plane onto an arbitrary polygon; that is, onto a polygon with any desired shape. On the other hand, it is not hard to define the mappings onto certain special polygons. This is especially easy for triangles since their shape is entirely determined by their angles. Thus, it follows e.g. that

$$f(z) = \int_0^z (\zeta^2 - 1)^{-2/3} d\zeta$$

maps the upper half-plane onto an equilateral triangle. □

Note: The techniques used above can be applied equally well to finding mappings from the upper half-plane onto a wide variety of polygonal regions. Many such examples, and much more information regarding Schwarz-Christoffel mappings, can be found in the classic book of Nehari.

Exercises

1. Verify directly that $f(z) = z^k$ is locally 1-1 for $z \neq 0$, k any nonzero integer.
2. Find the image under $\omega = e^z$ of the lines $x = \text{constant}$ and $y = \text{constant}$.
3. Find a conformal mapping f between the regions S and T , where
 - i. $S = \{z = x + iy : -2 < x < 1\}$; $T = D(0; 1)$
 - ii. $S = T = \text{the upper half-plane}$; $f(-2) = -1$, $f(0) = 0$ and $f(2) = 2$
 - iii. $S = \{re^{i\theta} : r > 0 \text{ and } 0 < \theta < \pi/4\}$; $T = \{x + iy : 0 < y < 1\}$
 - iv. $S = D(0; 1) \setminus [0, 1]$; $T = D(0; 1)$.

[Hint: For (iv) use the mapping of the upper semi-disc onto a quadrant.]

- 4.* Find a conformal mapping of the region "between" the circles: $|z| = 2$ and $|z - 1| = 1$ onto the unit disc.
- 5.* Find a conformal mapping of the semi-infinite strip: $x > 0, 0 < y < 1$ onto the unit disc.
- 6.* Find a conformal mapping of the semi-disc $S = \{z : |z| < 1, \text{Im } z > 0\}$ onto the unit disc.

- 7.* Verify that “conformal equivalence” satisfies the reflexive, symmetric and transitive properties of an equivalence relation.
8. a. Prove that a linear function maps polygons onto polygons.
b. Suppose f is entire and, for some rectangle R , $f(R)$ is a rectangle. Prove f is linear.
9. Prove that bilinear mappings form a group under composition.
10. Find the image of the circle $|z| = 1$ under the mappings
- $\omega = \frac{1}{z}$,
 - $\omega = \frac{1}{z-1}$,
 - $\omega = \frac{1}{z-2}$.

11. Show that the only automorphism of the unit disc with $f(0) = 0$, $f'(0) > 0$ is the identity map $f(z) \equiv z$.
12. Suppose f_1 and f_2 are both conformal mappings of a region D onto the unit disc and for some $z_0 \in D$,

$$f_1(z_0) = f_2(z_0) = 0; \quad f_1'(z_0), f_2'(z_0) > 0.$$

Prove $f_1 \equiv f_2$.

13. Show that all conformal mappings of a half-plane or disc onto a half-plane or disc are given by bilinear transformations.
14. What is the image of the upper half-plane under a mapping of the form

$$f(z) = \frac{az + b}{cz + d} \quad a, b, c, d \text{ real; } ad - bc < 0?$$

15. Find a formula for all the automorphisms of the first quadrant.
16. Complete Theorem 13.17 by showing h is of the form

$$h(z) = \frac{az + b}{cz + d} \quad a, b, c, d \text{ real; } ad - bc > 0.$$

[Hint: Write $h = h_1 \circ h_2$ where

$$h_1(z) = \left(\frac{z-i}{z+i}\right)^{-1} \circ e^{i\theta} z \circ \left(\frac{z-i}{z+i}\right)$$

$$h_2(z) = \left(\frac{z-i}{z+i}\right)^{-1} \circ \left(\frac{z-\alpha}{1-\bar{\alpha}z}\right) \circ \left(\frac{z-i}{z+i}\right).$$

Show, then that

$$h_1(z) = \frac{(1 + \cos \theta)z + \sin \theta}{(-\sin \theta)z + (1 + \cos \theta)}$$

$$h_2(z) = \frac{(1 - \operatorname{Re} \alpha)z + \operatorname{Im} \alpha}{(\operatorname{Im} \alpha)z + (1 + \operatorname{Re} \alpha)}.$$

17. Find the fixed points of the mappings
- $\omega = \frac{z-1}{z+1}$,
 - $\omega = \frac{z}{z+1}$.
18. Prove that (z_1, z_2, z_3, z_4) is real-valued if and only if the four points z_1, z_2, z_3, z_4 lie on a circle or line.

19. Find the bilinear mappings which send

- a. $1, i, -1$ onto $-1, i, 1$, respectively
- b. $-i, 0, i$ onto $0, i, 2i$, respectively
- c. $-i, i, 2i$ onto $\infty, 0, \frac{1}{3}$ respectively.

20. Find a conformal map f of the region between the two circles $|z| = 1$ and $|z - \frac{1}{4}| = \frac{1}{4}$ onto an annulus $a < |z| < 1$. [Hint: Find a bilinear map which simultaneously maps $|z| < 1$ onto $|z| < 1$ and $|z - \frac{1}{4}| < \frac{1}{4}$ onto a disc of the form $|z| < a$.]

21.* Find the image of the upper half-plane under the mapping $f(z) = \int_0^z 1/\sqrt{\zeta^2 - 1} d\zeta$. How is this function related to $\sin^{-1} z$?

22.* Find a mapping of the upper half-plane onto an isosceles right triangle.

23.* Find a mapping of the upper half-plane onto a square. [Hint: Let the point at infinity map onto one of the vertices of the square.]

Chapter 14

The Riemann Mapping Theorem

14.1 Conformal Mapping and Hydrodynamics

Before proving the Riemann Mapping Theorem, we examine the relation between conformal mapping and the theory of fluid flow. Our main goal is to motivate some of the results of the next section and the treatment here will be less formal than that of the remainder of the book.

Consider a fluid flow which is independent of time and parallel to a given plane, which we take to be the complex plane. The flow (or velocity) function g is then a two-dimensional or complex variable of two variables and we can write it in the form $g(z) = u(z) + iv(z)$ where u and v are real-valued. If we let σ and τ denote, respectively, the circulation around and the flux across a closed curve C , it can be shown that

$$\int_C \overline{g(z)} dz = \sigma + i\tau \quad (\text{see Appendix II}). \quad (1)$$

We will confine our attention to incompressible fluids and flows which are locally irrotational and source-free. That is, for any point z in our domain D , we assume there exists a $\delta > 0$ such that the circulation around and flux across any closed curve C in $D(z; \delta)$ is zero. Thus, for all such curves, if we define $f(z) = \overline{g(z)}$ it follows by (1) that $\int_C f(z) dz = 0$. We will assume moreover that g (and hence f) is continuous so that, by Morera's Theorem (7.4), f is analytic. Conversely, given an analytic $f = u - iv$ in a domain D , its conjugate $g = u + iv$ can be viewed as a locally irrotational and source-free flow in D .

EXAMPLES

- i. Suppose $f(z) = k$. Then $g(z) = \bar{k}$ represents a constant flow throughout \mathbb{C} .

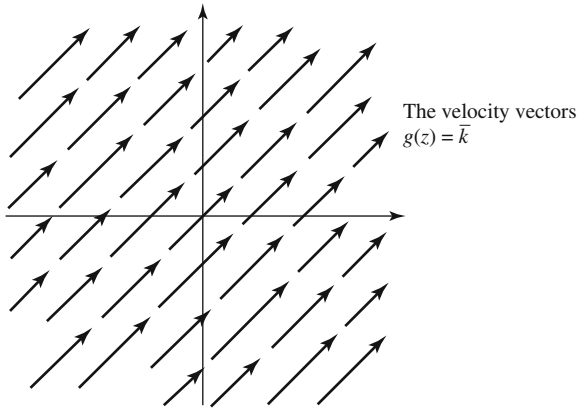

- ii Let $f(z) = z$. Then $g(z) = \bar{z}$ represents a flow which is tangent to the real and imaginary axes.

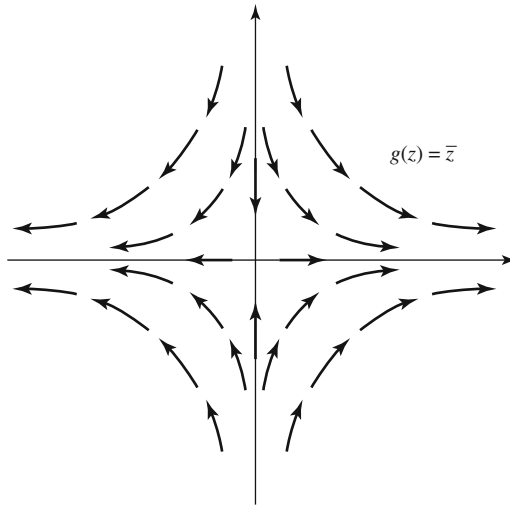

- iii. Let $f(z) = 1/z, z \neq 0$.

Then

$$g(z) = \overline{f(z)} = \frac{x + iy}{x^2 + y^2}$$

denotes a flow whose direction at z is the same as that of the vector (from 0) to z . In this case

$$\int_{|z|=\delta} f(z) dz = 2\pi i,$$

so that there is a nonzero flux across a circle centered at 0. Nevertheless the flow is locally irrotational and source-free in $z \neq 0$. (The flow is said to have a “source” at the origin.) \diamond

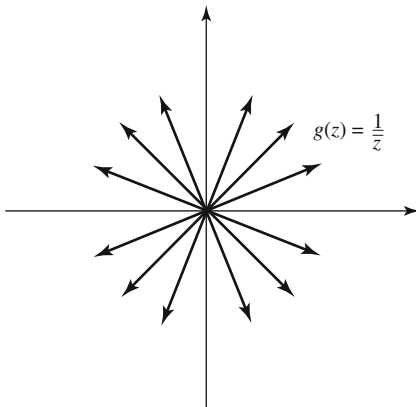

As the examples above suggest, the possible fluid flows of the type considered are as abundant as the analytic functions in a given region. To focus on the particular flow related to a canonical conformal mapping of a region D , we make the following further assumptions.

- A1. \tilde{D} is the closure of a bounded simply-connected region. (We will refer to \tilde{D} as a “barrier.”)
- A2. $g(z) = 1$ at ∞ . That is, $\lim_{z \rightarrow \infty} g(z) = 1$.
- A3. g has the direction of the tangent at the boundary of D (except for isolated points at which it may be zero or infinite).
- A4. The flow is *totally* irrotational and source-free; i.e., $\int_C f(z)dz = 0$ for every closed curve C contained in D .

Under the above assumptions, suppose $z_0 \in D$ and set $F(z) = \int_{z_0}^z f(\zeta)d\zeta$. By assumption (A4), F is well-defined and hence analytic in D . Moreover, according to (A2), $F(z) \sim z$ at ∞ . Finally, suppose the boundary of D is given by $z(t)$, $a \leq t \leq b$. Then

$$\frac{d}{dt}F(z(t)) = F'(z(t))\dot{z}(t) = \overline{g(z(t))}\dot{z}(t),$$

which is real-valued according to (A3). Hence F maps ∂D onto a horizontal segment.

The converse is equally valid. If F maps D conformally onto the exterior of a horizontal interval and $F(z) \sim z$ at ∞ , then $g(z) = \overline{F'(z)}$ will represent a fluid flow in D , satisfying assumptions (A1)–(A4).

EXAMPLES

- i. $F(z) = z + 1/z$ maps the exterior of the unit disc conformally onto the exterior of the interval $[-2, 2]$, and clearly $F(z) \sim z$ at ∞ . Thus

$$g(z) = \overline{F'(z)} = 1 - \frac{1}{z^2}$$

represents a fluid flow in the given region, satisfying (A1)–(A4). Note that $g(-1) = g(1) = 0$ and that the maximum speed is assumed at $\pm i$ where $|g(z)| = 2$.

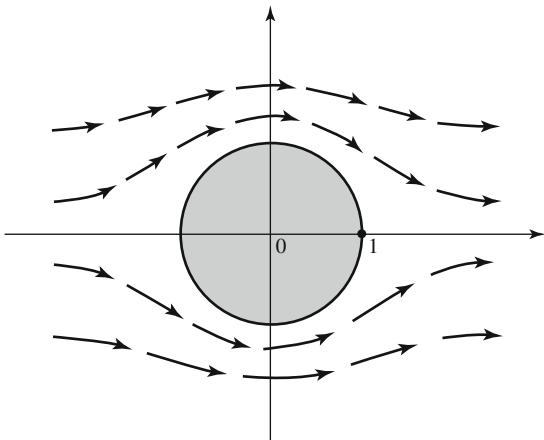

- ii. Suppose D is the complement of the interval I from $-i$ to i . Then an analytic $\sqrt{1 + z^2}$ can be defined there (see Chapter 10, Exercise 16). Note that if $\sqrt{1 + z^2}$ is taken to be positive on the positive axis, it is negative on the negative axis and maps D onto the exterior of $[-1, 1]$. Also $\sqrt{1 + z^2} \sim z$ at ∞ so that $F(z) = \sqrt{1 + z^2}$ is the desired conformal mapping and the flow is given by

$$g(z) = \overline{\left(\frac{z}{\sqrt{1 + z^2}} \right)}.$$

In this (idealized) case, $g(0) = 0$ and $g(\pm i) = \infty$. ◇

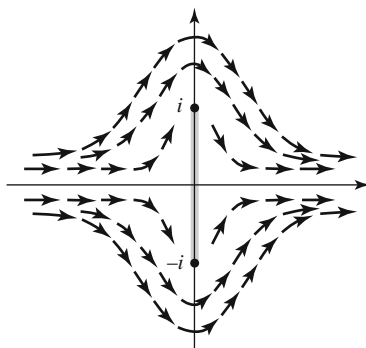

The examples above show how the appropriate mapping function enables us to obtain the fluid flow in a region. On the other hand, certain physical properties of the flow yield the following insights into conformal mapping.

I Existence and Uniqueness of Conformal Mappings As we have seen, the existence of a conformal mapping of a “single-barrier” domain onto the exterior of a

horizontal interval is equivalent to the existence of a flow function satisfying (A1)–(A4). However, it is known that a flow satisfying these assumptions exists and is unique. According to Kelvin’s Theorem [Milne-Thomson, p.95], the totally irrotational flow of a fluid occupying a region of the type considered (with the conditions at ∞ and along the boundary) is the unique flow with the least possible kinetic energy. The proof that such a unique flow exists can thus be given in terms of the partial differential equations governing the flow. We will not proceed that far with the physics, but we will be guided by the notion that a conformal mapping of the type sought is given by the solution to an extremal problem. We cast the problem in mathematical terms and complete the details in the next section.

II Conformal Mapping of Other Types of Domains By considering fluid flow throughout other types of domains, we can identify canonical domains to which they can be conformally mapped. In fact, reasoning like the above suggests that all domains with n “barriers” can be conformally mapped onto the plane slit along n horizontal line segments.

In the case of a simply connected domain D_1 , the standard canonical domain is the unit disc. For, if we fix $z_0 \in D_1$, the mapping given by $F_1(z) = 1/(z - z_0)$ maps D_1 onto a single barrier domain D_2 , sending z_0 into ∞ . We then can map D_2 conformally onto D_3 , the exterior of a horizontal interval, by a mapping F_2 . Similarly, the unit disc U is mapped

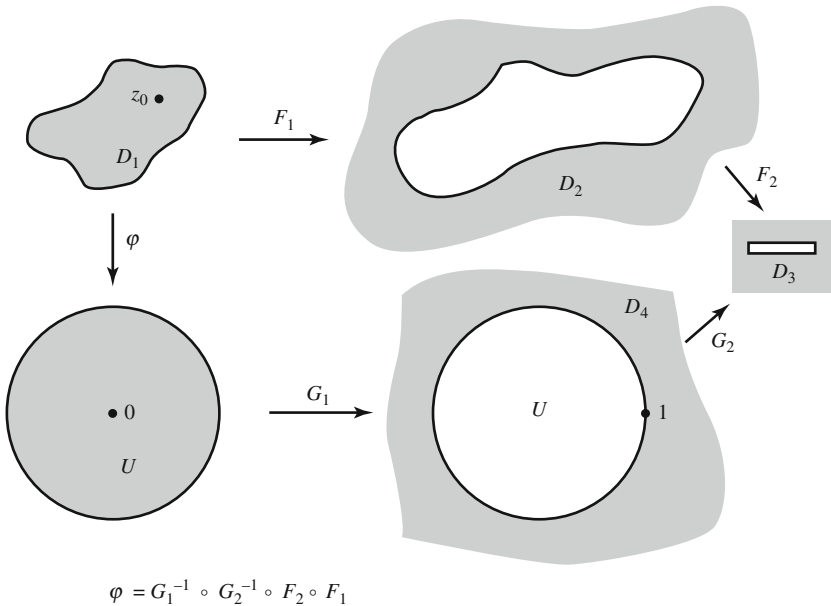

by $G_1(z) = 1/z$ onto the exterior of the unit circle, D_4 . Because D_4 is a single barrier domain, we have a conformal mapping G_2 of D_4 onto D_3 . Finally, the mapping

$$\varphi = G_1^{-1} \circ G_2^{-1} \circ F_2 \circ F_1$$

maps the simply-connected domain D_1 conformally onto the unit disc U . Note that in changing our canonical region from the exterior of an interval to the unit disc the condition $F(\infty) = \infty$ is replaced by $\varphi(z_0) = 0$.

14.2 The Riemann Mapping Theorem

The Riemann Mapping Theorem, in its most common form, asserts that any two simply connected, proper subdomains of the plane are conformally equivalent. That is, if $R_1, R_2 (\neq \mathbb{C})$ are simply connected regions, there exists a 1-1 analytic map of R_1 onto R_2 .

Note that the condition that $R_1, R_2 \neq \mathbb{C}$ is necessary, as a consequence of Liouville's Theorem. See Exercise 10.

To prove the theorem, it suffices to show that for any simply connected region $R (\neq \mathbb{C})$ there exists a conformal mapping of R onto U . For then, if R_1, R_2 are two simply connected, proper subdomains of \mathbb{C} , we have conformal mappings

$$\begin{aligned} f_1: R_1 &\rightarrow U \\ f_2: R_2 &\rightarrow U \end{aligned}$$

and $g = f_2^{-1} \circ f_1$ is a conformal mapping of R_1 onto R_2 .

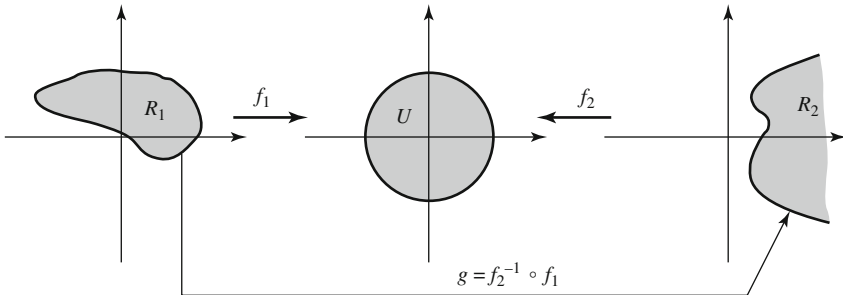

It is an easy exercise to show that given a conformal mapping f of R onto U and $z_0 \in R$, one can compose f with an appropriate automorphism of U so that the composite function φ maps R conformally onto U with the added properties that $\varphi(z_0) = 0$ and $\varphi'(z_0) > 0$. [See Exercise 6.] In fact, if we insist that φ be a conformal mapping of R onto U with these two additional properties, then the mapping is unique. We first prove the uniqueness and then we will prove the Riemann Mapping Theorem by showing that such a unique mapping φ exists.

Riemann Mapping Theorem

For any simply connected domain $R (\neq \mathbb{C})$ and $z_0 \in R$, there exists a unique conformal mapping φ of R onto U such that $\varphi(z_0) = 0$ and $\varphi'(z_0) > 0$.

Proof (Uniqueness)

Suppose φ_1 and φ_2 were two mappings with the above properties. Then $\Phi = \varphi_1 \circ \varphi_2^{-1}$ would be an automorphism of the unit disc with $\Phi(0) = 0$ and $\Phi'(0) > 0$. By 13.14, then, $\Phi(z) = e^{i\theta}z$ and since $\Phi'(0) = e^{i\theta} > 0$, it follows that Φ is the identity mapping. Hence, $\varphi_1 \equiv \varphi_2$.

(Existence) As we mentioned in the last section, we will find φ as the solution to an extremal problem. We recall some of the solutions to extremal problems for analytic mappings of U onto U that we obtained in Chapter 7. We found that, for fixed $\alpha \in U$, the 1-1 analytic mappings φ which maximize $|\varphi'(\alpha)|$ are precisely those of the form

$$\varphi(z) = e^{i\theta} \frac{z - \alpha}{1 - \bar{\alpha}z};$$

that is, those φ which

- i. map α onto 0 and
- ii. map U onto U .

(See Example 2 after 7.2 and Exercises 10 and 11 of Chapter 7.) This suggests a strategy for proving the existence of the conformal mapping φ of an arbitrary simply connected domain $R (\neq \mathbb{C})$ onto U . Namely, given R and $z_0 \in R$, we will consider the collection \mathcal{F} of all 1-1 analytic functions $f: R \rightarrow U$ satisfying $f'(z_0) > 0$ and take φ to be such that $\varphi'(z_0) = \sup_{f \in \mathcal{F}} f'(z_0)$. The details which we must show are the following.

- A. \mathcal{F} is nonempty.
- B. $\sup_{f \in \mathcal{F}} f'(z_0) = M < \infty$ and there exists a function $\varphi \in \mathcal{F}$ such that $\varphi'(z_0) = M$.
- C. With φ as in (B), φ is a conformal mapping of R onto U such that $\varphi(z_0) = 0$ and $\varphi'(z_0) > 0$. [The facts that $\varphi(z_0) = 0$ and that φ is an onto mapping are not guaranteed in (B).] \square

Proof of (A): Since $R \neq \mathbb{C}$, there exists a point $\rho_0 \in \tilde{R}$. [If \tilde{R} contains a disc $D(\rho_0; \delta)$, we can simply set $f(z) = \delta/(z - \rho_0)$ and it would clearly follow that $|f| < 1$ throughout R . It is possible, however, that \tilde{R} contains no discs at all so we must use a different approach.] Since R is simply connected, there exists an analytic function

$$g(z) = \sqrt{\frac{z - \rho_0}{z_0 - \rho_0}}$$

with $g(z_0) = 1$. It follows then that g must remain bounded away from -1 . For if

$$g(\zeta_n) = \sqrt{\frac{\zeta_n - \rho_0}{z_0 - \rho_0}} \rightarrow -1$$

then

$$\frac{\zeta_n - \rho_0}{z_0 - \rho_0} \rightarrow 1$$

so that $\xi_n \rightarrow z_0$. But then, by the continuity of g at z_0 , it would follow that $g(\xi_n) \rightarrow +1$ and the contradiction is apparent. Hence, for some $\eta > 0$, $|g(z)+1| > \eta$ throughout R . Thus, if we set $f(z) = \eta/(g(z) + 1)$, we will have $|f| < 1$. Since f is the composition of 1-1 functions, it too is 1-1 in R . Finally, since all the above properties are invariant under multiplication by $e^{i\theta}$ we can assume that $f'(z_0) > 0$ and hence $f \in \mathcal{F}$.

Proof of (B): Note, first, that since R is open, there exists some disc $D(z_0; 2\delta) \subset R$ and hence, for any $f \in \mathcal{F}$,

$$|f'(z_0)| = \left| \frac{1}{2\pi i} \int_{C(z_0; \delta)} \frac{f(z)}{(z - z_0)^2} dz \right| \leq \frac{1}{\delta},$$

by the usual $M - L$ estimate.

Suppose then that $M = \sup_{f \in \mathcal{F}} f'(z_0)$ and let f_1, f_2, \dots , be chosen so that $f'_n(z_0) \rightarrow M$ as $n \rightarrow \infty$. To show that there exists a function $\varphi \in \mathcal{F}$, such that $\varphi'(z_0) = M$, we will find a subsequence of $\{f_n\}_{n=1}^\infty$ which converges uniformly on compacta of R . To that end, let ξ_1, ξ_2, \dots be a countable dense subset of R . (For example, the ξ 's may be chosen as the points of R with rational coordinates.) Since $\{f_n(\xi_1)\}_{n=1}^\infty$ is a bounded sequence, there exists a subsequence $\{f_{1n}\}_{n=1}^\infty$ such that $\{f_{1n}(\xi_1)\}_{n=1}^\infty$ converges to some limit which we will denote $\varphi(\xi_1)$. Similarly $\{f_{1n}\}$ has a subsequence $\{f_{2n}\}$ such that $\{f_{2n}(\xi_2)\}$ converges and we denote its limit by $\varphi(\xi_2)$. Continuing in this manner, we obtain a nested sequence of subsequences $\{\{f_{kn}\}_{n=1}^\infty\}_{k=1}^\infty$ such that $\{f_{kn}\}_{n=1}^\infty$ converges at $\xi_1, \xi_2, \dots, \xi_k$. If we then take the "diagonal" subsequence $\{\varphi_n(z)\}_{n=1}^\infty$ with $\varphi_n = f_{nn}$, it follows that $\varphi_n(z)$ converges to the function denoted by φ for $z = \xi_1, \xi_2, \dots$.

We next wish to show that $\{\varphi_n\}$ converges throughout R and uniformly on any compact subset $\mathcal{K} \subset R$. We leave it as an exercise to show that any compact $\mathcal{K} \subset R$ is contained in a finite union of closed discs contained in R . Hence, we may assume, without loss of generality, that \mathcal{K} is itself a fixed compact disc in R . Note that $d(\mathcal{K}, \bar{R})$, the distance from \mathcal{K} to the closed set \bar{R} , is positive and we can set $d(\mathcal{K}, \bar{R}) = 2d > 0$. Hence, since $|\varphi_n| \leq 1$

$$|\varphi'_n(z)| = \left| \frac{1}{2\pi i} \int_{C(z; d)} \frac{\varphi_n(\xi)}{(\xi - z)^2} d\xi \right| \leq \frac{1}{2\pi} \cdot \frac{2\pi d}{d^2} = \frac{1}{d}, \quad z \in \mathcal{K}$$

and

$$|\varphi_n(z_1) - \varphi_n(z_2)| = \left| \int_{z_1}^{z_2} \varphi'_n(z) dz \right| \leq \frac{|z_1 - z_2|}{d}.$$

Thus, $\{\varphi_n\}$ is an "equicontinuous" sequence of functions on \mathcal{K} . That is, for each $\epsilon > 0$ and all n ,

$$|\varphi_n(z_1) - \varphi_n(z_2)| \leq \epsilon$$

as long as $|z_1 - z_2| \leq \epsilon d$. If we then take $z \in \mathcal{K}$ and $\epsilon > 0$, we can write $|\varphi_n(z) - \varphi_m(z)| \leq |\varphi_n(z) - \varphi_n(\xi_k)| + |\varphi_n(\xi_k) - \varphi_m(\xi_k)| + |\varphi_m(\xi_k) - \varphi_m(z)|$ and choosing ξ_k such that $|\xi_k - z| < \epsilon d/3$, it follows that

$$|\varphi_n(z) - \varphi_m(z)| < \epsilon$$

once n and m are chosen large enough so that

$$|\varphi_n(\zeta_k) - \varphi_m(\zeta_k)| < \frac{\epsilon}{3}.$$

Thus $\{\varphi_n(z)\}_{n=1}^{\infty}$ satisfies the Cauchy Criterion and converges for any $z \in \mathcal{K}$. Moreover, the limit function φ is continuous since

$$|\varphi(z_1) - \varphi(z_2)| = \lim_{n \rightarrow \infty} |\varphi_n(z_1) - \varphi_n(z_2)| < \epsilon, \quad z_1, z_2 \in \mathcal{K},$$

as long as $|z_1 - z_2| < \epsilon d$.

Finally, to show that $\varphi_n \rightarrow \varphi$ uniformly on compacta, we apply the following standard argument. Suppose $\epsilon > 0$ is given and set

$$S_j = \{z \in \mathcal{K} : |\varphi_n(z) - \varphi(z)| < \epsilon \quad \text{for } n > j\}.$$

Clearly $\mathcal{K} \subset \bigcup_{j=1}^{\infty} S_j$. Hence, since the sets S_j are open (by the equicontinuity of the functions φ_n) and \mathcal{K} is compact, we can choose N such that $\mathcal{K} \subset \bigcup_{j=1}^N S_j$. Thus, for all $z \in \mathcal{K}$, $|\varphi_n(z) - \varphi(z)| < \epsilon$ when $n > N$ and the convergence is uniform.

Since $\varphi_n \rightarrow \varphi$ uniformly on compacta, φ is analytic (Theorem 7.6). Also, according to Theorem 10.12

$$\varphi'(z_0) = \lim_{n \rightarrow \infty} \varphi'_n(z_0) = M > 0$$

so that φ is nonconstant. Since it is the uniform limit of 1-1 functions, φ is 1-1 in R (Theorem 10.15).

Proof of (C): It remains only to show that $\varphi(z_0) = 0$ and that φ maps R onto U . To see the former, assume that $\varphi(z_0) = \alpha$, $0 < |\alpha| < 1$. Then

$$f(z) = \frac{\varphi(z) - \alpha}{1 - \bar{\alpha}\varphi(z)}$$

is also a 1-1 analytic map of R into U with

$$f'(z_0) = \frac{\varphi'(z_0)}{1 - |\alpha|^2}.$$

Thus $f'(z_0) > \varphi'(z_0)$, which is impossible.

Assume next that $\varphi(z) \neq \omega$, $\omega = -t^2 e^{i\theta}$, $0 < t < 1$. If we set $g(z) = e^{-i\theta} \varphi(z)$, g too will map R into U , $g(z_0) = 0$ and $|g'(z_0)| = \varphi'(z_0)$. Moreover, $g(z) \neq -t^2$ for all $z \in R$. If we then set

$$f_1(z) = \frac{g(z) + t^2}{1 + t^2 g(z)}$$

it follows that f_1 maps R into U with $f_1(z_0) = t^2$. Since $g(z) \neq -t^2$, $f_1(z) \neq 0$ and there exists an analytic square root

$$f_2(z) = \sqrt{f_1(z)}$$

with $f_2(z_0) = t$. Next, let

$$f_3(z) = \frac{f_2(z) - t}{1 - tf_2(z)}.$$

Clearly f_3 is 1-1 and direct calculation shows that

$$\begin{aligned} f_1'(z_0) &= g'(z_0)(1 - t^4) \\ f_2'(z_0) &= \frac{f_1'(z_0)}{2\sqrt{f_1(z_0)}} = \frac{f_1'(z_0)}{2t} \\ f_3'(z_0) &= \frac{f_2'(z_0)}{1 - t^2} \end{aligned}$$

so that, combining the above equations,

$$f_3'(z_0) = \frac{g'(z_0)(1 + t^2)}{2t} \gg g'(z_0)$$

since $1 + t^2 > 2t$ for $0 < t < 1$. If we set $f(z) = e^{i\theta} f_3(z)$ we will have $f \in \mathcal{F}$ and such that $f'(z_0) > \varphi'(z_0)$ which is impossible. Hence, φ must be onto and the proof is complete. \square

Note: Consider the original sequence f_1, f_2, \dots such that $f_n'(z_0) \rightarrow M$ as $n \rightarrow \infty$. While the Riemann mapping function φ was obtained as the limit of a subsequence of $\{f_n\}$, it turns out that the original (full) sequence $\{f_n\}$ converges to φ . For suppose there existed some subsequence f_{n_1}, f_{n_2}, \dots such that

$$|f_{n_i}(z) - \varphi(z)| > \epsilon \tag{1}$$

for a fixed $z \in R$ and $\epsilon > 0$.

Then since $f_{n_k}'(z_0) \rightarrow M$ as $k \rightarrow \infty$, we could apply the previous proof to show that it has a subsequence which converges to the unique mapping function φ . But then (1) is impossible.

14.3 Mapping Properties of Analytic Functions on Closed Domains

Introduction

While the Riemann Mapping Theorem showed that any two open simply connected sets, other than \mathbb{C} , are conformally equivalent, there is no such theorem for closed or even for compact connected sets. In fact, there is often no *analytic* mapping of one closed domain onto another. As an example, there is no analytic mapping of the closed upper half-plane onto the closed first quadrant. If f were such an analytic function, it would map some real number x_0 onto the origin. Suppose $f'(x_0) \neq 0$. Then, according to Theorem 13.4, f would map the rays $I_1 = \{x_0 + t, 0 \leq t < \infty\}$ and $I_2 = \{x_0 - t, 0 \leq t < \infty\}$ onto two curves whose tangent lines form a straight angle.

But two such curves, which meet at the origin, cannot both lie in the first quadrant. Similarly, if f has a zero of order $k \geq 2$ at x_0 , we can complete the argument by considering the effect of f on I_1 and on the ray $\{x_0 + te^{\pi i/k}, 0 \leq t < \infty\}$.

The above argument might leave the impression that if we somehow “rounded the corner” of the first quadrant, the resulting region might possibly be the image of the closed upper half-plane under some analytic mapping. That, in fact, is not the case (Corollary 14.6), but it requires a separate argument.

On the positive side, while an analytic mapping of one closed domain onto another is not always possible, the theorem below shows that for certain types of regions, any conformal mapping between the interiors extends to a 1-1 *continuous* map between the closures.

Recall that a Jordan curve is a simple closed curve. As we noted in Chapter 10, the very intuitive (but difficult to prove) Jordan Curve Theorem asserts that any Jordan curve disconnects its complement in the complex plane into two disjoint regions: a bounded component known as its interior and an unbounded component known as its exterior.

14.2 Definition

A region R will be called a Jordan region if it is the interior of a Jordan curve.

14.3 Theorem (Carathéodory-Osgood):

Any conformal mapping between two Jordan regions can be extended to a homeomorphism between the closures of the two regions.

Like the Jordan Curve Theorem, the Carathéodory-Osgood Theorem is not easy to prove. Although we will use the result throughout this section, we refer the interested reader to the proofs in the classic texts of Ahlfors and Carathéodory.

A Jordan curve γ is *positively-oriented* if it has winding number one around its interior points. For circles, as we have seen, this is the counterclockwise direction. As with circles, the positive orientation is the one which has the interior points on the left as the curve is traversed. We can also define a triple $\{a_1, a_2, a_3\} \subset \partial R$ to be positively oriented with respect to ∂R if the parametrization of ∂R which passes through a_1, a_2, a_3 in that order is positively-oriented. Suppose f is a conformal mapping between two Jordan regions R_1 and R_2 . Then, according to the Argument Principle (see the comments following Corollary 10.9), the induced mapping between the boundaries must be orientation-preserving.

Based on the Carathéodory-Osgood Theorem, there are two additional ways to characterize a unique conformal mapping between any two Jordan regions.

14.4 Proposition:

Let R be any Jordan region, and let $\mathbb{D} = D(0; 1)$, $\mathbb{S} = \partial\mathbb{D} = C(0; 1)$. Then

- (i) *given a positively-oriented triple, $\{a_1, a_2, a_3\} \subset \partial R$ and a positively-oriented triple, $\{b_1, b_2, b_3\} \subset \mathbb{S}$, there exists a unique conformal mapping $f: R \rightarrow \mathbb{D}$ such that $f(a_k) = b_k$ for $k = 1, 2, 3$;*
- (ii) *given $z_0 \in R$, $a \in \partial R$ and $b \in \mathbb{S}$, there exists a unique conformal mapping from R to \mathbb{D} with $f(z_0) = 0$ and $f(a) = b$.*

Proof

To prove (i), take any conformal mapping of R onto \mathbb{D} and follow it with an automorphism of \mathbb{D} which maps the images of the three boundary points of R onto the three points of \mathbb{S} . [Such a mapping exists since Theorem 13.23 showed that there is a bilinear mapping T , sending the images of a_1, a_2, a_3 onto b_1, b_2, b_3 , respectively. Moreover, since both triples are positively oriented, T will also map \mathbb{D} onto itself.] To show that the mapping is unique, use the fact that if there were two such mappings f_1 and f_2 , $f_2 \circ f_1^{-1}$ would be an automorphism of the unit disc with three fixed points on the unit circle, and hence would be the identity (Proposition 13.19). To prove (ii), follow the usual Riemann mapping with the appropriate rotation so that the image of the boundary point a is mapped onto b . The uniqueness follows from Schwarz' Lemma. \square

Next we would like to consider the possibility of finding analytic (not necessarily conformal or even locally conformal) mappings from one closed region onto another. It is worth recalling that in this general context the boundary of a region is not necessarily mapped entirely onto the boundary of its image. For a simple example, consider the image of the rectangle $0 \leq x \leq 1, 0 \leq y \leq 2\pi$ under the mapping $f(z) = e^z$. (Also, see exercise 3 of chapter 7.) In many cases, however, we can determine the image of the boundary by using the following theorem.

Rigidity of Analytic Arcs

An arc $\gamma : I \rightarrow \mathbb{C}$ (I being a real interval) is said to be *analytic* if γ is the restriction to I of a function $\tilde{\gamma}$ which is analytic on an open set of \mathbb{C} containing I .

14.5 Theorem

Let $\gamma : I \rightarrow \mathbb{C}$ be an analytic arc where I is a compact real interval; let $\ell \subset \mathbb{C}$ be a circle or a line. If $\gamma [I] \cap \ell$ is infinite, then $\gamma [I] \subset \ell$.

Note that a very straightforward proof can be given for the case where ℓ is a line. By making a simple change of variables, we can assume that ℓ is a subset of the real line. In that case, $\text{Im } \gamma(t)$ is a "real" analytic function for $t \in I$. Since $\text{Im } \gamma(t)$ has infinitely many zeroes in I , it follows from the uniqueness theorem for real analytic functions that $\text{Im } \gamma(t)$ is identically zero and $\gamma(t) \in \mathbb{R}$ for all $t \in I$. A modified form of the proof can also be given for the case where ℓ is a circle. The following argument, however, is applicable to both lines and circles and highlights the fact that the theorem is really about analytic arcs.

Proof of Theorem 14.5. Let $\tilde{\gamma}$ be analytic on some domain Ω containing I with $\tilde{\gamma}|_I = \gamma$; we may arrange that Ω be symmetric about \mathbb{R} . Let $(\)^\dagger$ denote reflection across ℓ and consider $\omega(z) = (\tilde{\gamma}(\bar{z}))^\dagger$ for $z \in \Omega$. By the Schwarz reflection principle and by the symmetry of Ω , ω (like $\tilde{\gamma}$) is analytic in Ω . For $t \in I$ with $\gamma(t) \in \ell$, $\omega(t) = \gamma(t)$. But $\gamma(t) \in \ell$ for infinitely many values of t , so that according to the uniqueness theorem (6.10), $\omega \equiv \tilde{\gamma}$ throughout Ω . In particular, for all $t \in I$,

$$\gamma(t) = \tilde{\gamma}(t) = \omega(t) = (\gamma(t))^\dagger,$$

which implies that $\gamma [I] \subset \ell$. \square

14.6 Corollary

If f is an analytic mapping of the closed upper half-plane, and if the boundary of its image contains a line segment J , then the boundary of the image is a subset of the line containing J .

Proof

Note that the boundary of the image is a subset of the analytic curve $f(\mathbb{R})$. If the boundary includes a line segment J , a standard set-theoretic argument shows that, for sufficiently large N , $f([-N, N])$ contains infinitely many points of J . But then, according to Theorem 14.5, the boundary is entirely contained in the line determined by J . \square

It is a well-known consequence of the maximum modulus principle that any nonconstant function g which is \mathbb{C} -analytic in \mathbb{D} , mapping $\overline{\mathbb{D}}$ onto $\overline{\mathbb{D}}$ and \mathbb{S} into \mathbb{S} is of the form

$$g(z) = e^{i\theta} \prod_{k=1}^n \frac{z - \alpha_k}{1 - \overline{\alpha_k}z} \quad \text{for some } n \in \mathbb{N}, \alpha_k \in \mathbb{D}, \text{ and } \theta \in \mathbb{R}. \quad (1)$$

(See the solution to Chapter 7, exercise 5.) According to Theorem 14.5, if g is analytic in $\overline{\mathbb{D}}$, the condition that g maps \mathbb{S} into \mathbb{S} can be dispensed with. Thus we have

14.7 Corollary

An analytic function mapping $\overline{\mathbb{D}}$ onto $\overline{\mathbb{D}}$ is of the form (1).

Proof

Given such an analytic function f , it suffices to show that $f[\mathbb{S}] = \mathbb{S}$. Note that $\mathbb{S} = \partial(f[\overline{\mathbb{D}}]) \subset f[\mathbb{S}]$ by the open mapping theorem. Thus $f[\mathbb{S}] \cap \mathbb{S} = \mathbb{S}$. Theorem 14.5 then shows that the analytic arc $f[\mathbb{S}]$ is a subset of \mathbb{S} . Hence $f[\mathbb{S}] = \mathbb{S}$. \square

14.8 Corollary

If an entire function f maps \mathbb{D} onto \mathbb{D} , then $f(z) = cz^n$ for some $c \in \mathbb{S}$.

Proof

Clearly $f[\overline{\mathbb{D}}] = \overline{\mathbb{D}}$. By Corollary 14.7, $f(z) = e^{i\theta} \prod_{k=1}^n (z - \alpha_k)/(1 - \overline{\alpha_k}z)$ for some $\alpha_k \in \mathbb{D}$ and $\theta \in \mathbb{R}$. Since f is entire, all the points α_k must be zero, so that $f(z) = e^{i\theta} z^n$. \square

It follows that any entire function f mapping some disc onto a disc is of the form

$$f(z) = \alpha(z - z_0)^n + w_0$$

for some $\alpha, z_0, w_0 \in \mathbb{C}$ and $n \in \mathbb{N}$.

Analytic Mappings Between Polygons

Does there exist any analytic function which maps a closed convex n -gon onto another closed convex n -gon? Of course, if the polygons are similar, there is an elementary linear mapping between them. But what if they are not similar? The somewhat surprising answer is a very general NO, even if all the angles are identical, as would be the case with two dissimilar rectangles. In fact, we begin our inquiry by first considering rectangles. We then answer the question for the smallest n (i.e., $n = 3$) and finally address the general problem by induction on n . We note at the end of this section that the convexity condition on the polygons is actually not necessary.

14.9 Theorem

An analytic function f that maps a closed rectangle R onto another closed rectangle S is a linear polynomial.

Theorem 14.5 will play a crucial role here, allowing us to show that $f[\partial R] = \partial S$.

Proof

Assume without loss of generality that

$$R = [0, a] \times [0, b] \quad \text{and} \quad S = [0, c] \times [0, d].$$

First, note that f will *not* turn a straight line into an angle unequal in measure to an integral multiple of π , because, where $f' \neq 0$, f is conformal, and, where $f' = 0$, f magnifies angles by an integral factor. Therefore, f will not map any nonvertex point on ∂R to a vertex of S . We thus make the following observation:

Each vertex of S has precisely one preimage, which is a vertex of R . Hence, the image of each vertex of R must be a vertex of S and f gives a one-to-one correspondence between the vertices of R and those of S .

By the open mapping theorem, no interior point of R will be mapped by f to ∂S , and therefore $\partial S \subset f[\partial R]$. It is a simple set-theoretic matter that there is a side ℓ of ∂R such that $f[\ell] \cap [0, c]$ is infinite. Theorem 14.5 then implies that $f[\ell] \subset [0, c]$. Without loss of generality, we may assume that $\ell = [0, a]$, in which case either $f(0) = 0$ and $f(a) = c$, or $f(0) = c$ and $f(a) = 0$. But the latter possibility cannot happen, because f , being analytic, must preserve the orientation of the boundary. It then follows from the intermediate value theorem that $f[\ell] = [0, c]$.

Similarly we conclude that the side $\{c + is : s \in [0, d]\} \subset S$ must be the image of some side of R , and, since $f(a) = c$, that side of R must be $\{a + ir : r \in [0, b]\} \subset R$. Continuing until we exhaust all four sides of S , we then have established:

f maps each side of R onto a side of S .

Finally, reflection across the sides of R allows us to extend f (by the Schwarz reflection principle) to rectangles adjacent and congruent to R . Continuing this reflection process, we obtain an *entire* function, which by construction has at most linear growth in modulus. Hence, by the Extended Liouville Theorem (5.11), f must be a linear polynomial. \square

We note those elements of the preceding argument that are applicable in general.

14.10 Lemma

Suppose an analytic function f maps some closed n -gon R onto a closed n -gon S . Then:

- Each vertex of S has precisely one preimage, which is a vertex of R , and f maps each side of R monotonically onto a side of S .
- If R and S are both convex, each interior angle of R has the same measure as the corresponding interior angle of S .

Proof

For part (a), given the argument for Theorem 14.9, we only need to establish monotonicity of f on each side of R . Let ℓ be a side of R . If $f(z)$ were to reverse direction as z traverses ℓ , there would be some $\mu \in \ell$ with $f'(\mu) = 0$. At the critical point μ , f magnifies angle by an integral factor. Hence the image of any μ -centered semidisc contained in R would lie partly outside of S , contradicting our hypothesis!

To show part (b), denote by $m(V)$ the measure of an interior angle with vertex V . For any vertex A of R , let $A' = f(A)$. Then, by analyticity of f , $m(A') = k_{AM}(A)$ for some $k_A \in \mathbb{N}$ (and, by convexity of S , $k_A m(A) < \pi$). Since R and S are both convex n -gons,

$$\sum_A m(A) = \sum_A m(A') = \sum_A k_A m(A).$$

Hence $k_A = 1$ for every vertex A . □

We turn now to the general case. The strategy will be to first solve the problem for triangles and then to use induction on the number of sides of the polygons in question to prove the general case.

14.11 Lemma

If an analytic function f maps a closed n -gon R onto a closed n -gon S , then f gives a conformal equivalence between their interiors: \mathring{R} and \mathring{S} .

It is interesting that it is the isolated singularities (i.e., vertices) on ∂R and ∂S that force f to be conformal. Were the boundaries analytic Jordan curves, no conclusion about the valence of f on R could be drawn (as can be seen by considering z^n on the unit disc).

Proof

By Lemma 14.10(a), $f[\partial R] = \partial S$ and $f|_{\partial R}: \partial R \rightarrow \partial S$ is univalent. Thus the winding number of $f|_{\partial R}$ around any point in \mathring{S} is exactly one. By the argument principle, f is a conformal equivalence between \mathring{R} and \mathring{S} . □

We now apply Lemma 14.11 to resolve the triangle case.

14.12 Lemma

An analytic function f that maps some closed triangle R onto another closed triangle S is a linear polynomial.

Proof

By Lemma 14.10(b), the two triangles R and S have equal corresponding angles and are therefore similar. We then can easily construct an affine map g mapping R onto S , which is *a fortiori* conformal. If R is not equilateral, g is unique; if R is equilateral, let g be such that it agrees with f on the vertices of R . By Lemma 14.11, f gives a conformal equivalence between \mathring{R} and \mathring{S} . Since f and g agree on the three vertices of R , by Proposition 14.4, $f = g!$ □

Finally, we are able to completely answer the question raised at the beginning of this section.

14.13 Theorem

An analytic function mapping some closed convex n -gon R onto another closed convex n -gon S is a linear polynomial.

Proof

If R is a rectangle, then, according to Lemma 14.10(b), S is also a rectangle. By Theorem 14.9, f is a linear polynomial.

Suppose then that R is a nonrectangular quadrilateral. Note that there is at least one interior angle of R that is obtuse. Denote by ℓ_1 and ℓ_2 the two sides of R that form this angle. Reflect R across ℓ_1 and denote by R' the reflected image of R . Extend ℓ_2 to a full line L_2 . Then L_2 divides R' into two regions, one of which is a triangle. Call this triangle T . See the diagram below.

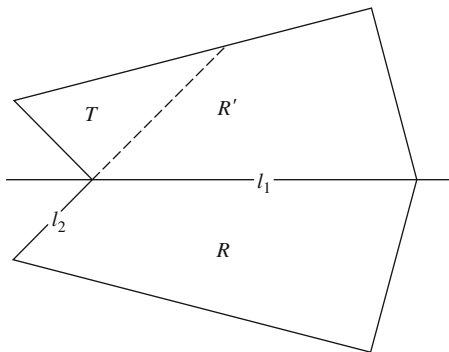

Observe that, by the Schwarz reflection principle, f can be analytically continued to R' and this extended map (which we also call f) maps R' onto the similarly-constructed quadrilateral S' . Since $f[\ell_2]$ is a side of S , by Theorem 14.5, $f[L_2 \cap R']$ is also a line segment. Therefore $f[\partial T]$ is the boundary of a triangle Δ ; by considering

the winding number of $f|_{\partial T}$, we deduce that $f[\mathring{T}] = \mathring{\Delta}$. Hence $f[T] = \Delta$, and, according to Lemma 14.12, f must be a linear polynomial.

To complete the proof for $n > 4$, we proceed as in the quadrilateral case and use induction on n . Given a convex n -gon R with $n > 4$, there must be an interior angle that is obtuse. Otherwise, the formula for the sum of interior angles would be violated. Reflect R across one of the two sides forming this obtuse angle and extend the other side to divide R' (the reflected image of R) into two regions, one of which is a convex polygon T with fewer than n sides. As in the quadrilateral case, f extends analytically to R' and maps T onto another convex polygon; it is immediate that the polygon $f[T]$ has the same number of sides as T . The induction hypothesis then guarantees that f is a linear polynomial. \square

In the rectangle case, we first showed that the analytic function in question can be extended to an entire function, and then used its order of growth to prove that it is linear. In the case of other convex polygons, we showed that the analytic function in question can be analytically continued to a mapping between two triangles, which allowed us to conclude that it is a linear polynomial. In both cases, the Schwarz reflection principle and Theorem 14.5 played pivotal roles.

Note also that the convexity condition on the polygons in Theorem 14.13 can be dispensed with. This slightly more general result will follow easily. The idea is that, by extending the sides forming an interior angle greater than a straight angle, we can find a convex polygon that is mapped analytically to a convex polygon. We leave the details to the interested reader.

Conformal Mappings Between Dissimilar Rectangles

Among entire functions, linear polynomials are the only ones that are conformal on every domain. Since a linear polynomial is a composition of rotation, real multiplication, and translation, the two rectangles in Theorem 14.9 and the two n -gons in Theorem 14.13 are actually similar.

Let R and S be two closed rectangles that are *not similar* to each other and let f be a *conformal* map from \mathring{R} onto \mathring{S} (whose existence is guaranteed by the Riemann mapping theorem). By the Carathéodory-Osgood theorem, f extends to a homeomorphism $\tilde{f}: R \rightarrow S$. The argument in the proof of Theorem 14.9 shows that

- the extension \tilde{f} of f to ∂R fails to be analytic at some point on ∂R ;
- at least one vertex of R fails to be mapped by \tilde{f} to a vertex of S .

We can attempt to make \tilde{f} “as analytic as possible” by requiring that three of the four vertices of R be mapped to vertices of S ; then by the Schwarz reflection principle, \tilde{f} will be analytic on the two sides of R bounded by the three vertices. Note that, according to Proposition 14.4, the requirement that three chosen vertices of R be mapped to three chosen vertices of S uniquely determines the conformal equivalence f between \mathring{R} and \mathring{S} . One can express such a map explicitly with the aid of the Schwarz-Christoffel formulae, and this will offer an illustration of the fact that

the interiors of two dissimilar rectangles cannot be put into a conformal equivalence that extends to a vertex-preserving homeomorphism.

To focus on a simple concrete example, let $R = [-1, 1] \times [0, r]$ and $S = [-1, 1] \times [0, s]$. Let \mathbb{H} denote the upper half-plane and let $F_R : \mathbb{H} \rightarrow R$ be the Riemann map with

$$\tilde{F}_R(-1) = -1, \quad \tilde{F}_R(0) = 0, \quad \tilde{F}_R(1) = 1. \tag{1}$$

Then F_R is given by the elliptic integral

$$F_R(z) = C_r \int_0^z \frac{1}{\sqrt{(1-\xi^2)(1-k_r^2\xi^2)}} d\xi$$

where $k_r = 1/a_r$ and $C_r = 1/\int_0^1 [(1-\xi^2)(1-k_r^2\xi^2)]^{-1/2} d\xi$. It follows from the definition of F_R that $a_r = \tilde{F}_R^{-1}(1+ir)$ increases monotonocally with r and that

$$\tilde{F}_R(\pm a_r) = \pm 1 + ir.$$

In the same manner, let $F_S : \mathbb{H} \rightarrow S$ be the Riemann Mapping, also satisfying conditions (1) and with a_s similarly defined.

Suppose $f : \mathring{R} \rightarrow \mathring{S}$ is a conformal equivalence with

$$\tilde{f}(-1) = -1, \quad \tilde{f}(1) = 1, \quad \tilde{f}(1+ir) = 1+is.$$

We will see that, if $r \neq s$, $\tilde{f}(-1+ir) \neq -1+is$ and hence $\tilde{f}^{-1}(-1+is)$ is not a vertex of R , which implies that \tilde{f} cannot be analytic at $\tilde{f}^{-1}(-1+is)$. To this end, we consider $g = F_S^{-1} \circ f \circ F_R : \mathbb{H} \rightarrow \mathbb{H}$. See the diagram below.

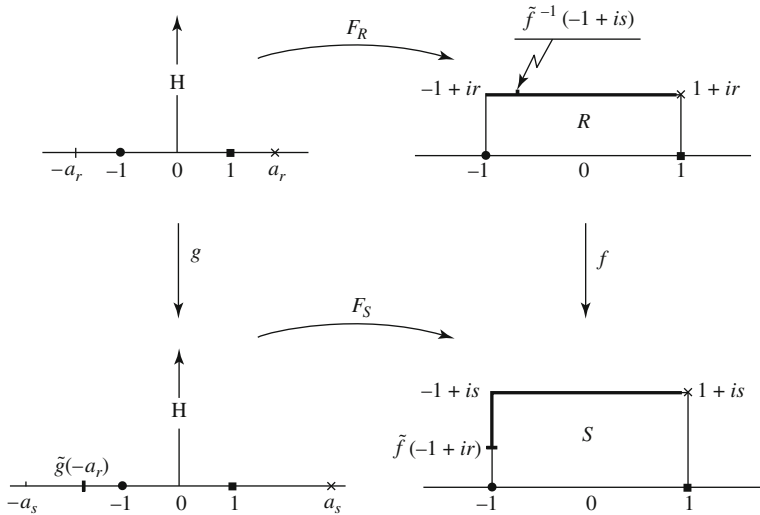

The map g is an automorphism of the upper half-plane. Hence it is a bilinear mapping with

$$\tilde{g}(-1) = -1, \quad \tilde{g}(1) = 1, \quad \tilde{g}(a_r) = a_s, \quad \text{with } 1 < a_r, a_s. \quad (2)$$

If $\tilde{f}(-1 + ir) = -1 + is$, we would also have $\tilde{g}(-a_r) = -a_s$. Since the cross-ratio is preserved under bilinear transformations, it would follow that $(-a_r, -1, 1, a_r) = (-a_s, -1, 1, a_s)$, or equivalently:

$$\frac{(a_r + 1)^2}{4a_r} = \frac{(a_s + 1)^2}{4a_s} \quad (3)$$

It is easy to see, however, that (3) is possible if and only if either $a_r = a_s$ or $a_r a_s = 1$. The latter equation is impossible, according to (2). Hence $a_r = a_s$ and we have the desired conclusion: f maps vertices of R to vertices of S only if R and S are similar.

If $r < s$, then $a_r < a_s$. So, if we let $\tilde{g}(-a_r) = -b$, by the preservation of cross-ratios, $b < a_r$. This translates into the sketch of the conformal mapping f in the above diagram. Note that the top side of R is bent by \tilde{f} into an L -shaped path and that \tilde{f} fails to be analytic at precisely one point, i.e., at $\tilde{f}^{-1}(-1 + is)$.

Finally, observe that, despite the fact that $f[R]$ is a rectangle, the image of any subrectangle $Q \subset \mathring{R}$ must *not* be a rectangle; for, otherwise, f would map \overline{Q} onto a rectangle and thus have to be a linear polynomial, in which case R would necessarily be similar to S .

Exercises

- Suppose g represents a locally irrotational and source-free flow in a simply-connected domain D and $F(z) = \int_{z_0}^z \bar{g}(\zeta) d\zeta$. Show that g is orthogonal to the curves given by $\operatorname{Re} F(z) = \text{constant}$.
- If F and g are as in (1), show that the curves $\operatorname{Im} F(z) = \text{constant}$ are the “streamlines” of g ; i.e., show that the flow is tangent to those curves.
- Find the streamlines of the flow functions given by
 - $g(z) = \bar{z}$
 - $g(z) = 1/\bar{z}, z \neq 0$.
- Verify directly that $F(z) = z + 1/z$ is the unique conformal mapping (up to an additive constant) of $|z| > 1$ onto the exterior of a horizontal interval, with $F(z) \sim z$ at ∞ [Hint: Begin with the Laurent Expansion

$$F(z) = z + A_0 + \frac{A_1}{z} + \frac{A_2}{z^2} + \dots$$

and use the fact that $\operatorname{Im} F(e^{i\theta}) = \text{constant}$ (see Markushevich, p. 189).]

5. a. Show that $w = 2z + 1/z$ maps the exterior of the unit circle conformally onto the exterior of the ellipse:

$$\frac{x^2}{9} + y^2 = 1.$$

- b. Find a conformal mapping of the exterior of the ellipse $x^2/9 + y^2 = 1$ onto the exterior of a real line segment.
6. Given a conformal mapping f of R onto U (the unit disc) and $z_0 \in R$, find a conformal mapping g of R onto U with $g(z_0) = 0$ and $g'(z_0) > 0$.
- 7.* Let R be a simply connected region $\neq \mathbb{C}$, which is symmetric with respect to the real axis; and suppose that f is the Riemann mapping of R onto U , with $f(z_0) = 0$, $f'(z_0) > 0$, for some real-valued $z_0 \in R$. Prove that $f(\bar{z}) = \overline{f(z)}$ for all $z \in R$.
- 8.* Find the unique conformal mapping of the upper half-plane onto the unit disc with
- $f(-1)$, $f(0)$, $f(1)$ equal to 1 , i , and -1 , respectively.
 - $f(i) = 0$ and $f(1) = 1$.
9. Let R be simply-connected and assume $z_1, z_2 \in R$. Show there exists a conformal mapping of R onto itself, taking z_1 into z_2 . (Consider two cases: $R \neq \mathbb{C}$ and $R = \mathbb{C}$.)
10. Suppose R is any simply connected domain $\neq \mathbb{C}$. Show that there exists no conformal mapping of \mathbb{C} onto R .
11. Let R be a simply connected region and $z_0 \in R$. Suppose G is defined as the set of all analytic functions $g : R \rightarrow U$ such that $g'(z_0) > 0$ (g need *not* be 1-1).
- Show that

$$\sup_{g \in G} g'(z_0) = M^* < \infty.$$

- Assuming that $\Phi'(z_0) = M^*$, show that Φ is 1-1 in R . [*Hint*: Show that Φ is the Riemann mapping function.]
- 12.* a. Find a conformal mapping f from the semi-disc $S = \{z : |z| < 1, \operatorname{Im} z > 0\}$ onto the unit disc U and show that it extends to a homeomorphism between \overline{S} and \overline{U} .
- Show that f is analytic on \overline{S} but f^{-1} is not analytic on \overline{U} .
- 13.* Prove that there is no analytic mapping from \overline{U} onto a “Norman window”, which is a closed region whose boundary is a rectangle surmounted by a semicircle.

Chapter 15

Maximum-Modulus Theorems for Unbounded Domains

15.1 A General Maximum-Modulus Theorem

The Maximum-Modulus Theorem (6.13) shows that a function which is C -analytic in a compact domain D assumes its maximum modulus on the boundary. In general, if we consider unbounded domains, the theorem no longer holds. For example, $f(z) = e^z$ is analytic and unbounded in the right half-plane despite the fact that on the boundary $|e^z| = |e^{iy}| = 1$. Nevertheless, given certain restrictions on the growth of the function, we can conclude that it attains its maximum modulus on the boundary. The most natural such condition is that the function remain bounded throughout D .

15.1 Theorem

Suppose f is C -analytic in a region D . If there are two constants M_1 and M_2 such that

$$\begin{aligned} |f(z)| &\leq M_1 \quad \text{for } z \in \partial D \\ |f(z)| &\leq M_2 \quad \text{for all } z \in D \end{aligned}$$

then, in fact,

$$|f(z)| \leq M_1 \quad \text{for all } z \in D.$$

Proof

Without loss of generality, we suppose $|f(z)| \leq 1$ on ∂D . Assuming, then, that $|f(z)| \leq M$ in D , we wish to prove $|f(z_0)| \leq 1$ for every $z_0 \in D$. We will first prove the theorem in the special case where D is the right half-plane and then extend the proof to a general region.

In the case of the right half-plane, fix $z_0 \in D$ and consider the auxiliary function

$$h(z) = \frac{f^N(z)}{z + 1}$$

where N is a positive integer. By the hypothesis on f , $|h(z)| \leq 1$ on the imaginary axis and $|h(z)| \leq M^N/R$ for all $z \in D$ such that $|z| = R$. Thus we have

$|h(z)| \leq \text{Max}(1, M^N/R)$ on the boundary of the right semi-circle $D_R = \{z \in D : |z| \leq R\}$. Choosing $R > M^N$ and large enough so that $z_0 \in D_R$, we conclude $|h(z)| \leq 1$ along the boundary of the compact domain D_R and hence by the Maximum Modulus Theorem $|h(z_0)| \leq 1$. Thus for each $z_0 \in D$

$$\left| \frac{f^N(z_0)}{z_0 + 1} \right| \leq 1$$

or

$$|f(z_0)| \leq |z_0 + 1|^{1/N}.$$

If we now let $N \rightarrow \infty$, we see $|f(z_0)| \leq 1$ as desired.

In the more general case, where D is an arbitrary region, we must replace $1/(z+1)$ by a function g , analytic in D and such that $g(z) \rightarrow 0$ as $z \rightarrow \infty$. Such a function is given by

$$g(z) = \frac{f(z) - f(a)}{z - a}$$

where a is any fixed point in D . Clearly g , like f , is C -analytic in D (Proposition 6.7). The boundedness of f assures $g(z) \rightarrow 0$ as $z \rightarrow \infty$ and this, in turn, implies that $|g(z)| \leq K$, some constant, throughout \bar{D} .

Again, we set $D_R = \{z \in D : |z| \leq R\}$. Setting $h(z) = f^N(z)g(z)$, because $g \rightarrow 0$ as $z \rightarrow \infty$ we may take R large enough so that $|h(z)| \leq K$ along the boundary of D_R . Hence, by the Maximum Modulus Theorem, $|h(z_0)| \leq K$ for every $z_0 \in D$. Assuming, then, that $g(z_0) \neq 0$, we can write

$$|f(z_0)| \leq \left| \frac{K}{g(z_0)} \right|^{1/N},$$

and letting $N \rightarrow \infty$ yields $|f(z_0)| \leq 1$. Note, finally, that unless f is constant, the zeroes of g form a discrete set (Theorem 6.9); hence, by continuity,

$$|f(z_0)| \leq 1 \text{ for every } z_0 \in D. \quad \square$$

The above theorem may be used to derive the following stronger form of Liouville's Theorem.

15.2 Definition

Let γ be a path parameterized by $\gamma = \gamma(t)$, $0 \leq t < \infty$. We will say that f approaches infinity along γ if, for any positive integer N , there exists a point t_0 such that

$$|f(\gamma(t))| \geq N \quad \text{for all } t \geq t_0.$$

15.3 Theorem

If f is a nonconstant entire function, there exists a curve along which f approaches infinity.

Note: An equivalent formulation of Liouville's Theorem (5.10) is that, for any non-constant entire function f , there exists a sequence of points z_1, z_2, \dots such that $f(z_n) \rightarrow \infty$ as $n \rightarrow \infty$. However, the existence of a curve along which $f \rightarrow \infty$ does not immediately follow. If we simply connect the points z_1, z_2, \dots successively, we have no control over the behavior of f at the intermediate points. The proof of Theorem 15.3 will depend on judiciously choosing the points z_k and the connecting lines so that we can guarantee that $f \rightarrow \infty$ along the path thus formed.

Proof of Theorem 15.3

Let $T_1 = \{z : |f(z)| > 1\}$ and fix S_1 , a connected component of T_1 . We will need the following facts about S_1 :

- S_1 is an open set
- $|f(z)| = 1$ for $z \in \partial S_1$
- f is unbounded on S_1 .

(a) is immediate. To prove (b), we first note that $|f(z)| \geq 1$ on the boundary of S_1 by continuity. If $|f(z)| > 1$ for some $z \in \partial S_1$, then $|f(w)| > 1$ for all w in a neighborhood of z and thus z would be an interior, rather than a boundary point of S_1 . Finally, if f were bounded throughout S_1 , we could apply (b) and Theorem 15.1 to show $|f(z)| \leq 1$ throughout S_1 , contradicting its definition.

Now set $T_2 = \{z \in S_1 : |f(z)| > 2\}$ and choose a connected component S_2 . (Note that, by (c), T_2 is non-empty.) As above, we can prove that f is unbounded on S_2 . Proceeding inductively, we obtain a sequence of regions

$$S_1 \supset S_2 \supset S_3 \supset \dots$$

such that $|f(z)| > k$ for all $z \in S_k$.

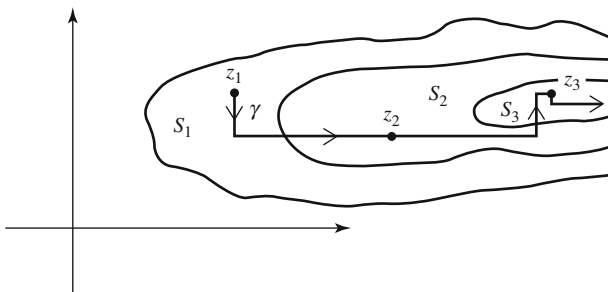

Finally, we choose a point $z_k \in S_k$ for $k = 1, 2, \dots$. Since each set S_k is a region which contains all points z_n , $n \geq k$, we can connect z_k to z_{k+1} by a polygonal path γ_k contained in S_k . Thus $|f(z)| > k$ for all $z \in \gamma_k$. If we then form the path $\gamma = \bigcup_{k=1}^{\infty} \gamma_k$, it follows that f approaches ∞ along γ , proving the theorem. \square

15.2 The Phragmén-Lindelöf Theorem

We now return to theorems of maximum-modulus type.

Theorem 15.1 is rather general in that it applies to any region. On the other hand, if we restrict ourselves to various specific regions D , we will be able to derive the same type of conclusion under a much weaker hypothesis on f . We begin, as before, by considering the right half-plane. As previously noted, the function e^z is unbounded in this domain despite the fact that it is bounded by 1 on the imaginary axis. The same, of course, is true of the function $e^{\delta z}$ for any $\delta > 0$. However, if $f(z)$ has slower growth than $e^{\delta z}$, we have the following extension of Theorem 15.1.

15.4 Phragmén-Lindelöf Theorem

Let D denote the right half-plane and suppose f is C -analytic in D . If

$$|f(z)| \leq 1 \tag{1}$$

on the imaginary axis and if, for each $\epsilon > 0$, there exists a constant A_ϵ such that

$$|f(z)| \leq A_\epsilon e^{\epsilon|z|} \tag{2}$$

throughout D , then (1) holds for all $z \in D$.

Before proceeding with the proof, we will need the following lemma, which is a slightly weaker form of the theorem.

Lemma 1

Suppose f is C -analytic in the right half-plane D . If

$$|f(z)| \leq 1 \tag{3}$$

on the imaginary axis, and if for some $\delta > 0$, there exist constants A and B such that

$$|f(z)| \leq A \exp(B|z|^{1-\delta}) \tag{4}$$

for all $z \in D$, then (3) holds throughout D .

Proof of Lemma 1

Here we use the auxiliary function

$$h(z) = \frac{f^N(z)}{\exp(z^{1-\delta/2})}$$

and wish to show $|h(z_0)| \leq 1$ for each $z_0 \in D$. Let us first analyze the denominator $g(z) = \exp(z^{1-\delta/2})$. In the open right half-plane $z^{1-\delta/2}$ may be defined as an analytic function (see the comments following Theorem 8.8). To fix its value, we take it to

be positive on the positive real axis. Then, for $z = re^{i\theta}$, $-\pi/2 < \theta < \pi/2$,

$$z^{1-\delta/2} = r^{1-\delta/2} e^{i\theta(1-\delta/2)}, \quad -\frac{\pi}{2} < \theta < \frac{\pi}{2}$$

which is also continuous to the boundary.

Finally,

$$g(z) = \exp(z^{1-\delta/2}) = \exp(r^{1-\delta/2} e^{i\theta(1-\delta/2)}).$$

Thus, for $z = iy$

$$|g(z)| = \exp\left(|y|^{1-\delta/2} \cos\left(1 - \frac{\delta}{2}\right) \frac{\pi}{2}\right) \geq e^0 = 1 \tag{5}$$

and for $|z| = R$, $z \in D$,

$$|g(z)| = \exp\left(R^{1-\delta/2} \cos\left(1 - \frac{\delta}{2}\right) \theta\right) \geq \exp(R^{1-\delta/2} m). \tag{6}$$

where m is the minimum value of

$$\cos\left(1 - \frac{\delta}{2}\right) \theta, \quad -\frac{\pi}{2} < \theta < \frac{\pi}{2}.$$

Now consider $|h(z)|$ on the boundary of D_R . On the imaginary axis, by (3) and (5), $|h(z)| \leq 1$. For $|z| = R$, by (4) and (6),

$$|h(z)| \leq A^N \exp(NBR^{1-\delta} - mR^{1-\delta/2}).$$

Since the expression in parenthesis approaches $-\infty$ as $R \rightarrow \infty$, we have for R large enough, $|h(z)| \leq 1$ on the boundary of D_R . Once again, invoking the maximum modulus theorem,

$$|h(z_0)| \leq 1$$

for every $z_0 \in D$ and thus

$$|f(z_0)| \leq |\exp(z_0^{1-\delta/2})|^{1/N}.$$

Finally, letting $N \rightarrow \infty$ gives the desired result. □

Note: While the lemma was stated in the right half-plane, it is obviously true in any other half-plane as well. For example, if f satisfies the growth conditions (3) and (4) in the upper half-plane, $g(z) = f(-iz)$ would satisfy the hypotheses of the lemma. Hence, $g \ll 1$ in the right half-plane and $f \ll 1$ in the upper half-plane.

Similarly, by mapping other regions analytically onto the right half-plane, we can derive results similar to Lemma 1 for functions which are C -analytic in the given regions. We record one example which will serve as another lemma to Theorem 15.4.

Lemma 2

Suppose f is C -analytic in a quadrant. If $|f(z)| \leq 1$ on the boundary and if for some $\delta > 0$, there exist constants A and B such that

$$|f(z)| \leq A \exp(B|z|^{2-\delta}) \text{ for every } z \text{ in the quadrant,}$$

then $|f(z)| \leq 1$ throughout the quadrant.

Proof of Lemma 2

Without loss of generality, we consider the first quadrant. Set $g(z) = f(\sqrt{z})$. Then g is C -analytic in the upper half-plane. Furthermore, by the hypothesis on f , $|g(z)| \leq 1$ on the boundary and

$$|g(z)| \leq A \exp(B|z|^{1-\delta/2})$$

throughout the half-plane. By Lemma 1, $|g(z)| \leq 1$ throughout the half-plane and thus $|f(z)| \leq 1$ for all points z in the quadrant. \square

Proof of Theorem 15.4

We consider

$$h(z) = \frac{f^N(z)}{e^z}$$

and, as before, the proof will follow if we can show $|h(z)| \leq 1$ throughout the right half-plane. To do this, we consider the first and fourth quadrants separately. To estimate $h(z)$ on the boundary of the first quadrant, note that $|e^{iy}| = 1$ and hence, by (1)

$$|h(z)| \leq 1 \quad \text{on the positive imaginary axis.}$$

Also, by (2), $|f(z)| \leq A_{1/N} e^{(1/N)|z|}$ so that setting $B_N = (A_{1/N})^N$, $|f^N(z)| \leq B_N e^{|z|}$ throughout the half-plane. On the positive x -axis, though, $|e^z| = e^{|z|}$ and hence $|h(z)| \leq B_N$ for $z > 0$. Thus $|h(z)| \leq \text{Max}(1, B_N)$ along the boundary of the first quadrant. Furthermore, throughout the first quadrant

$$|h(z)| \leq |f^N(z)| \leq B_N e^{|z|}$$

so that we can apply Lemma 2 to conclude

$$|h(z)| \leq \text{Max}(1, B_N)$$

in the first quadrant. By the exact same reasoning,

$$|h(z)| \leq \text{Max}(1, B_N)$$

in the fourth quadrant. Hence $h(z)$ is a bounded C -analytic function in the right half-plane and is bounded by 1 on the imaginary axis. By Theorem 15.1, $|h(z)| \leq 1$ throughout the right half-plane, and the proof is complete. \square

By mapping a wedge of angle α onto the right half-plane, we derive the following corollary.

15.5 Corollary

Let

$$D = \left\{ z : -\frac{\alpha}{2} < \text{Arg } z < \frac{\alpha}{2} \right\}, \text{ where } 0 < \alpha \leq 2\pi,$$

and suppose f is C -analytic in D . If

$$|f(z)| \leq 1 \tag{1}$$

on ∂D and if, for each $\epsilon > 0$, there exists a constant A_ϵ such that

$$|f(z)| \leq A_\epsilon \exp(\epsilon |z|^{\pi/\alpha}), \tag{2}$$

then (1) holds throughout D .

Proof

Given f as above, consider $g(z) = f(z^{\alpha/\pi})$ in the right half-plane and apply Theorem 15.4. \square

An interesting special case of the corollary arises if we take a wedge of angle 2π (the whole plane slit along one ray). In that case, the boundary is a single ray and, by the above corollary, if f is bounded on that ray and has slower growth than $e^{\epsilon\sqrt{|z|}}$ for each $\epsilon > 0$, it is in fact bounded throughout the wedge. Now, we may view an entire function as a C -analytic function in every wedge of angle 2π . This leads to the following theorem.

15.6 Theorem

If f is a non-constant entire function and for each $\epsilon > 0$ there exists a constant A_ϵ such that

$$|f(z)| \leq A_\epsilon e^{\epsilon\sqrt{|z|}}$$

then $f(z)$ is unbounded on every ray!

Proof

If f were bounded on some ray R , by Corollary 15.5 it would also be bounded on the wedge $\mathbb{C} \setminus R$; that is, f would be bounded in the entire plane. But, then, by Liouville's Theorem f would reduce to a constant, contradicting the hypothesis of the theorem. \square

EXAMPLE

$\cos z$ has a power series involving only even terms, hence $\cos \sqrt{z}$ is an entire function that is bounded on the positive x -axis. Hence, by the above theorem, it must grow

as fast as $e^{\epsilon\sqrt{|z|}}$ for some $\epsilon > 0$. Setting

$$\cos z = \frac{e^{iz} + e^{-iz}}{2}$$

shows that this is in fact the case. (Consider points z along the imaginary axis.) \diamond

An Application of Theorem 15.6: The differential equation $f'(z) = -f(z)$ has the explicit solution $f(z) = Ae^{-z}$. However, if we consider the very similar equation

$$f'(z) = -f\left(\frac{z}{2}\right) \quad (1)$$

no such explicit solution can be found. Nevertheless, one may seek to study the behavior of a solution $f(z)$ as $z \rightarrow \infty$ along the positive x -axis. To accomplish this, we will find the solution in the form of a power series which is, in fact, an entire function. Furthermore, we will show that the solution is of “small” growth, so that Theorem 15.6 is applicable, and f is unbounded on every ray. Thus, unlike Ae^{-z} , the solution to (1) has no limit as $z \rightarrow +\infty$. The details are as follows:

15.7 Proposition

Let f be a solution of the differential equation $f'(z) = -f(z/2)$, analytic at $z = 0$. Then f is entire and is unbounded on every ray.

Proof

Let f have the power series representation

$$f(z) = \sum_{k=0}^{\infty} a_k z^k.$$

Because of (1), we must have

$$\sum_{k=1}^{\infty} k a_k z^{k-1} = - \sum_{k=1}^{\infty} a_k \left(\frac{z}{2}\right)^k$$

or

$$a_k = -\frac{a_{k-1}}{2^{k-1}k}.$$

By induction, then,

$$a_n = \frac{(-1)^n a_0}{n! 2^{n(n-1)/2}}.$$

Hence $f(z)$ is given by

$$f(z) = A \sum_k b_k z^k \quad \text{where } b_k = \frac{(-1)^k}{k! 2^{k(k-1)/2}}, \quad (2)$$

and a simple check shows that (2) does in fact represent an entire solution of (1).

We now show that f satisfies the hypothesis of Theorem 15.6. For this we fix $\epsilon > 0$ and show that, for z sufficiently large,

$$|f(z)| < \exp(|z|^\epsilon).$$

Assume then that $|z| = R = 2^N$, $N > 2$, and let

$$M(R) = \text{Max}_{|z|=R} |f(z)|, \quad M = M(1).$$

According to (1),

$$\begin{aligned} f(z) - f(0) &= \int_0^z f'(\rho) d\rho = \int_0^z -f\left(\frac{\rho}{2}\right) d\rho \\ &\ll RM\left(\frac{R}{2}\right) \end{aligned}$$

so that

$$|f(z)| \leq 2RM\left(\frac{R}{2}\right).$$

Setting $M(R/2) = |f(z_1)|$ for some $z_1 \in D(0; R/2)$ and proceeding inductively, we obtain

$$|f(z)| \leq MR^N = M|z|^{\log z / \log 2}. \quad (3)$$

The right-hand side of (3) is bounded above by $\exp(|z|^\epsilon)$ for *all* z sufficiently large; therefore, we get $R_0 = R_0(\epsilon)$ such that

$$|f(z)| < \exp(|z|^\epsilon)$$

for all z with $|z| \geq R_0$, as desired. \square

Exercises

- * Show that the conclusion of Theorem 15.1 would hold if we insisted only that $f \ll 1$ along the boundary and $f(z) \ll \log z$ throughout the domain. How could the hypothesis be further relaxed?
- What is the “smallest” non-constant analytic function in the quadrant $D = \{x + iy : x, y < 0\}$, which is bounded along the boundary?
- Show that $e^{e^z} \ll 1$ throughout the boundary of the region

$$D = \left\{x + iy : -\frac{\pi}{2} < y < \frac{\pi}{2}\right\}.$$

Show that it is the “smallest” such analytic function.

- * Suppose g is a non-constant entire function which is bounded on every ray. (See 12.2). Show that for any A and B , there must exist some point z with $|g(z)| > A \exp(|z|^B)$. [Hint: If not, divide the plane into a finite number of very small wedges and apply 15.5 and Liouville’s Theorem to conclude that g is constant.]

Chapter 16

Harmonic Functions

16.1 Poisson Formulae and the Dirichlet Problem

In this chapter, we focus on the real parts of analytic functions and their connection with real harmonic functions.

16.1 Definition

A real-valued function $u(x, y)$ which is twice continuously differentiable and satisfies Laplace's equation

$$u_{xx} + u_{yy} = 0$$

throughout a domain D is said to be *harmonic* in D .

Although one may talk of complex-valued harmonic functions, the term “harmonic” throughout this chapter will always refer to a real-valued function.

16.2 Theorem

If $f = u + iv$ is analytic in D , u and v are harmonic there.

Proof

u and v both have continuous partial derivatives of all orders since f is analytic. By the Cauchy-Riemann equations

$$u_x = v_y; \quad u_y = -v_x$$

so that

$$u_{xx} = v_{yx} = v_{xy} = -u_{yy},$$

hence u is harmonic. By the same argument, v is harmonic since it is the real part of the analytic function $-if$. \square

The converse of the above is not true. For example,

$$u(x, y) = \log(x^2 + y^2)$$

is harmonic in the punctured plane but is not the real part of an analytic function there. (See Exercise 4.) We do have the following partial converse:

16.3 Theorem

If u is harmonic in D , then

- u_x is the real part of an analytic function in D ;
- if D is simply connected, u is the real part of an analytic function in D .

Proof

- Let $f = u_x - iu_y$. Since $u \in C^2$, f has continuous first-order partial derivatives. Moreover, by the harmonicity of u

$$f_y = u_{xy} - iu_{yy} = u_{yx} + iu_{xx} = if_x$$

so that f satisfies the Cauchy-Riemann equations. Hence f is analytic in D .

- If D is simply connected, by the Integral Theorem (8.5), $f = u_x - iu_y$ is the derivative of an analytic function F . But then if $F = A + iB$

$$F'(z) = A_x + iB_x = A_x - iA_y = u_x - iu_y$$

so that

$$A(x, y) = u(x, y) + C.$$

Hence $u(x, y)$ is the real part of the analytic function $F(z) - C$. □

EXAMPLE

$u(x, y) = x - e^x \sin y$ is harmonic in the whole plane. Hence $f(z) = u_x(z) - iu_y(z) = 1 - e^x \sin y + ie^x \cos y$ is entire. In fact, $f(z) = 1 + ie^z$ and if we set

$$F(z) = \int_0^z f(\zeta) d\zeta = z + ie^z - i,$$

then

$$u(z) = \operatorname{Re} F(z).$$

◇

The fact that a harmonic function is, at least locally, the real part of an analytic function allows us to apply some of the theory of analytic functions to harmonic functions.

16.4 Mean-Value Theorem for Harmonic Functions

If u is harmonic in $D(z_0; R)$,

$$u(z_0) = \frac{1}{2\pi} \int_0^{2\pi} u(z_0 + re^{i\theta}) d\theta$$

for all positive $r < R$.

Proof

Let $u = \operatorname{Re} f$. By 6.12

$$f(z_0) = \frac{1}{2\pi} \int_0^{2\pi} f(z_0 + re^{i\theta}) d\theta,$$

and the result follows by taking the real parts of the above. \square

16.5 Maximum-Modulus Theorem for Harmonic Functions

If u is a nonconstant harmonic function in a region D , u has no maximum or minimum points in D .

Proof

The theorem may be derived as a corollary of the above Mean-Value Theorem. It follows even more immediately, however, from the Open Mapping Theorem (7.1). For in a disc $D(z_0; \delta) \subset D$ about any point $z_0 \in D$, u is the real part of an analytic function f . Since f maps $D(z_0; \delta)$ onto an open set, u takes both larger and smaller values than $u(z_0)$ in the open disc. \square

Note that the Maximum-Modulus Theorem for analytic functions (6.13) asserts only that $|f|$ has no interior maximum point; $|f|$ can have a local minimum if it is equal to zero. By contrast, Theorem 16.5 shows that a non-constant harmonic function has neither a maximum nor a minimum point in the interior of a domain.

We let the term *C-harmonic* refer to a function which is harmonic in the interior of a domain and continuous on the closure. The previous theorem implies then that a *C-harmonic* function in a compact domain must assume its maximum and minimum values on the boundary of that domain.

16.6 Corollary

If two C-harmonic functions u_1 and u_2 agree on the boundary of a compact domain D , then $u_1 = u_2$ throughout D .

Proof

$u = u_1 - u_2$ is *C-harmonic* in D ; hence it takes its maximum and minimum on the boundary. Since $u \equiv 0$ on the boundary, it follows that $u \equiv 0$ throughout D and that $u_1 \equiv u_2$. \square

Corollary 16.6 shows that a *C-harmonic* function is determined by its values on the boundary of a compact domain. But this result is of a purely theoretical nature. How to determine the value at an interior point from a knowledge of u on the boundary is the subject of the next theorem. We begin by considering *C-harmonic* functions in the unit disc.

16.7 Theorem

Suppose u is C -harmonic in $D(0;1)$. Then

$$u(z) = \frac{1}{2\pi} \int_0^{2\pi} u(e^{i\theta}) \mathcal{K}(\theta, z) d\theta$$

where $\mathcal{K}(\theta, z)$ is the “Poisson Kernel,”

$$\mathcal{K}(\theta, z) = \operatorname{Re} \left[\frac{e^{i\theta} + z}{e^{i\theta} - z} \right].$$

In polar form,

$$u(re^{i\varphi}) = \frac{1}{2\pi} \int_0^{2\pi} \frac{u(e^{i\theta})(1-r^2)}{1-2r\cos(\theta-\varphi)+r^2} d\theta.$$

Proof

[To simplify the notation, we will assume $u = \operatorname{Re} f$ where f is analytic on the closed unit disc. To justify the assumption, we could first prove the theorem for $u^*(z) = u(rz)$ where $r < 1$ and then take the limit as $r \rightarrow 1$ since u is uniformly continuous on $\overline{D(0;1)}$.]

By the Cauchy Integral Formula (6.4)

$$f(z) = \frac{1}{2\pi i} \int_{|\zeta|=1} \frac{f(\zeta)}{\zeta - z} d\zeta$$

or

$$f(z) = \frac{1}{2\pi} \int_0^{2\pi} f(e^{i\theta}) \left[\frac{e^{i\theta}}{e^{i\theta} - z} \right] d\theta \quad (1)$$

If we replace z by the symmetric point $1/\bar{z}$ which lies outside the unit disc, then by the Closed Curve Theorem (8.6)

$$0 = \frac{1}{2\pi i} \int_{|\zeta|=1} \frac{f(\zeta)}{\zeta - \frac{1}{\bar{z}}} d\zeta$$

or

$$0 = \frac{1}{2\pi} \int_0^{2\pi} f(e^{i\theta}) \left[\frac{e^{i\theta}}{e^{i\theta} - 1/\bar{z}} \right] d\theta. \quad (2)$$

Note that

$$\begin{aligned} \frac{e^{i\theta}}{e^{i\theta} - 1/\bar{z}} &= \frac{\bar{z}e^{i\theta}}{\bar{z}e^{i\theta} - 1} = \frac{-\bar{z}}{e^{-i\theta} - \bar{z}} \\ &= 1 - \frac{e^{-i\theta}}{e^{-i\theta} - \bar{z}} = \overline{\left[1 - \frac{e^{i\theta}}{e^{i\theta} - z} \right]}, \end{aligned}$$

so that subtracting (2) from (1) yields

$$\begin{aligned} f(z) &= \frac{1}{2\pi} \int_0^{2\pi} f(e^{i\theta}) \left[\frac{e^{i\theta}}{e^{i\theta} - z} + \overline{\left(\frac{e^{i\theta}}{e^{i\theta} - z} \right)} - 1 \right] d\theta \\ &= \frac{1}{2\pi} \int_0^{2\pi} f(e^{i\theta}) \left[2 \operatorname{Re} \left(\frac{e^{i\theta}}{e^{i\theta} - z} \right) - 1 \right] d\theta, \end{aligned}$$

or

$$f(z) = \frac{1}{2\pi} \int_0^{2\pi} f(e^{i\theta}) \operatorname{Re} \left[\frac{e^{i\theta} + z}{e^{i\theta} - z} \right] d\theta. \quad (3)$$

Finally, taking the real parts of the above, we obtain

$$u(z) = \frac{1}{2\pi} \int_0^{2\pi} u(e^{i\theta}) \operatorname{Re} \left[\frac{e^{i\theta} + z}{e^{i\theta} - z} \right] d\theta. \quad (4)$$

□

By mapping the unit disc onto other domains, we can obtain similar results for any simply connected domain. For example, if u is harmonic in $D(0; R)$, $u = \operatorname{Re} f$, we can apply the above results to $g(\zeta) = f(R\zeta)$. Thus

$$f(R\zeta) = \frac{1}{2\pi} \int_0^{2\pi} f(Re^{i\theta}) \operatorname{Re} \left[\frac{e^{i\theta} + \zeta}{e^{i\theta} - \zeta} \right] d\theta,$$

and if we let $R\zeta = z$

$$f(z) = \frac{1}{2\pi} \int_0^{2\pi} f(Re^{i\theta}) \operatorname{Re} \left[\frac{Re^{i\theta} + z}{Re^{i\theta} - z} \right] d\theta, \quad (5)$$

and

$$u(z) = \frac{1}{2\pi} \int_0^{2\pi} u(Re^{i\theta}) \operatorname{Re} \left[\frac{Re^{i\theta} + z}{Re^{i\theta} - z} \right] d\theta. \quad (6)$$

The above is known as the Poisson Integral Formula for a disc. The Poisson Formula for a bounded harmonic function in a half-plane

$$u(x + iy) = \frac{1}{\pi} \int_{-\infty}^{\infty} \frac{yu(t)}{(t-x)^2 + y^2} dt \quad (7)$$

is derived in Exercise 6.

The Dirichlet Problem The Dirichlet Problem is the problem of proving the existence of a function u which is C -harmonic in a domain and assumes prescribed boundary values. This differs from the attitude in the last section where a function u was assumed to be C -harmonic in a domain and we sought a formula for u in terms of its boundary values. Nevertheless, the previous theorems offer a starting point. Suppose, for example, that D is the unit disc. Then if there is a harmonic function u

in D with limit values $u(e^{i\theta})$ on the boundary, u must be of the form

$$u(z) = \frac{1}{2\pi} \int_0^{2\pi} u(e^{i\theta}) \operatorname{Re} \left[\frac{e^{i\theta} + z}{e^{i\theta} - z} \right] d\theta,$$

or

$$u(re^{i\varphi}) = \frac{1}{2\pi} \int_0^{2\pi} \frac{u(e^{i\theta})(1-r^2)}{1-2r\cos(\theta-\varphi)+r^2} d\theta.$$

The fact that this Poisson Integral does indeed provide the solution to the Dirichlet Problem is proven below.

16.8 Theorem

Suppose $u(e^{i\theta})$ is continuous on $C(0; 1)$. Then

$$u(z) = \frac{1}{2\pi} \int_0^{2\pi} u(e^{i\theta}) \mathcal{K}(\theta, z) d\theta$$

is the restriction to $D(0; 1)$ of a C -harmonic function in the closed unit disc with boundary values $u(e^{i\theta})$.

Proof

Let

$$g(z) = \frac{1}{2\pi} \int_0^{2\pi} u(e^{i\theta}) \left[\frac{e^{i\theta} + z}{e^{i\theta} - z} \right] d\theta, \quad |z| < 1.$$

Since $(e^{i\theta} + z)/(e^{i\theta} - z)$ is an analytic function of z for each θ and since g is continuous, it follows by Morera's Theorem that g is analytic in $D(0; 1)$. Moreover, $u(z) = \operatorname{Re} g(z)$ so that u is harmonic. To show that u has the limit $u(e^{i\theta})$ as $z \rightarrow e^{i\theta}$, we note the following properties of the Poisson Kernel

$$\mathcal{K}(\theta, z) = \frac{1-r^2}{1-2r\cos(\theta-\varphi)+r^2}, \quad z = re^{i\varphi}. \quad (8)$$

i. $\mathcal{K}(\theta, z) > 0$.

The numerator is obviously positive and the denominator is bigger than $(1-r)^2$.

ii. $(1/2\pi) \int_0^{2\pi} \mathcal{K}(\theta, z) d\theta = 1$.

This follows on applying the Poisson Formula (16.7) with $u \equiv 1$.

iii. For every $\delta > 0$

$$\left[\int_0^{\varphi-\delta} \mathcal{K}(\theta, z) d\theta + \int_{\varphi+\delta}^{2\pi} \mathcal{K}(\theta, z) d\theta \right] \rightarrow 0 \quad \text{as } z \rightarrow e^{i\varphi}.$$

Note that the denominator in (8) is bounded away from zero for $|\theta - \varphi| > \delta$ while the numerator approaches 0 as z approaches the boundary.

According to (ii) we can write

$$u(re^{i\varphi}) - u(e^{i\varphi}) = \frac{1}{2\pi} \int_0^{2\pi} [u(e^{i\theta}) - u(e^{i\varphi})] \mathcal{K}(\theta, z) d\theta.$$

Let $M = \text{Max}_\theta |u(e^{i\theta})|$. By the continuity of u , given $\epsilon > 0$ we can find $\delta > 0$ so that $|u(e^{i\theta}) - u(e^{i\varphi})| < \epsilon$ when $|\theta - \varphi| < \delta$. Then by (ii) and (iii)

$$\begin{aligned} |u(re^{i\varphi}) - u(e^{i\varphi})| &\leq \frac{M}{\pi} \left[\int_0^{\varphi-\delta} \mathcal{K}(\theta, z) d\theta + \int_{\varphi+\delta}^{2\pi} \mathcal{K}(\theta, z) d\theta \right] \\ &\quad + \frac{1}{2\pi} \int_{\varphi-\delta}^{\varphi+\delta} \epsilon \mathcal{K}(\theta, z) d\theta \\ &\leq \frac{M}{\pi} \left[\int_0^{\varphi-\delta} \mathcal{K}(\theta, z) d\theta + \int_{\varphi+\delta}^{2\pi} \mathcal{K}(\theta, z) d\theta \right] + \epsilon, \end{aligned}$$

and as $r \rightarrow 1$

$$\overline{\lim}_{r \rightarrow 1} |u(re^{i\varphi}) - u(e^{i\varphi})| \leq \epsilon.$$

Hence

$$\lim_{r \rightarrow 1} u(re^{i\varphi}) = u(e^{i\varphi}). \quad (9)$$

Since u was assumed to be continuous on the unit circle and u is harmonic (and hence continuous) in the disc, it follows from (9) that u is continuous in \bar{D} with the prescribed values on the boundary. \square

Remarks

1. According to Corollary 16.6, the above solution to the Dirichlet Problem is unique.
2. The arguments above show that for any integrable function u on the unit circle, there is a harmonic function in $D(0; 1)$ with limit $u(e^{i\varphi})$ at any point of continuity of u along the boundary.
3. By considering the appropriate conformal mapping f of D onto U , we can solve the Dirichlet Problem for any bounded simply connected domain. To find a harmonic function u_1 in D with given boundary values, we first determine a harmonic function u_2 in U with the values $u_1(f^{-1}(z))$ along the boundary. Since u_2 is the real part of an analytic function g ,

$$u_1(z) = u_2(f(z)) = \text{Re } g(f(z))$$

is the desired harmonic function in D .

4. In many simple cases, an explicit solution to the Dirichlet Problem can be obtained (without recourse to the Poisson Integral) by determining an analytic function with the appropriate real part.

EXAMPLES

- i. To determine the C -harmonic function u in $D(0; 1)$ with boundary values $u(x, y) = x^2$, note that

$$\operatorname{Re} z^2 = x^2 - y^2$$

is everywhere harmonic and equals $2x^2 - 1$ on the boundary. Hence

$$u(x, y) = \frac{1}{2}(x^2 - y^2) + \frac{1}{2}.$$

By taking linear combinations of the above with the harmonic polynomials $1, x, y$ and xy , we can find a C -harmonic function in $D(0; 1)$ with boundary values equal to any given quadratic polynomial on $C(0; 1)$.

- ii. $\log r = \operatorname{Re} \log z$ is a harmonic function in the punctured plane $z \neq 0$ which depends only on the modulus. [Although $\log z$ is only analytic in a slit plane, $\operatorname{Re} \log z = \log |z|$ is continuous and hence harmonic in the entire punctured plane.]

Thus if A is an annulus: $r_1 \leq |z| \leq r_2$, we can find a harmonic function in A with arbitrary constant values on the inner and outer circles by setting $u(re^{i\phi}) = a \log r + b$ for appropriate a and b . \diamond

An Application to Heat Problems. Suppose we consider a solid whose temperature u is constant in one direction. (This is a reasonable model for a cylindrical solid with insulated faces or for a “very long” cylindrical solid.) If we assume that the temperature is independent of time, then, thinking of the solid as resting in a region of the z plane, the temperature depends only on the x, y position and can be shown to be a harmonic function. [See Appendix III.] For that reason, Laplace’s equation: $u_{xx} + u_{yy} = 0$, is sometimes called the heat equation and Dirichlet problems can be thought of as boundary-value heat problems. Such problems can thus be solved by the methods discussed. It is often helpful to first map the given region onto a simpler one where a solution to the corresponding problem is known.

EXAMPLES

- i. Suppose the annulus $1 \leq |z| \leq 2$ represents the cross-section of an “infinite” cylindrical solid with temperature 100° maintained on the outer rim and temperature 0° on the inner rim. Then, as in the previous example, the temperature is given by

$$u(re^{i\phi}) = \left(\frac{\log r}{\log 2} \right) 100^\circ.$$

In particular, the isothermal line with temperature 50° is the circle of radius $\sqrt{2}$.

- ii. Next we find the “steady-state” temperature function in the unit disc with boundary values 1 on the upper semi-circle and 0 on the lower semi-circle. Note that $w = (z - 1)/(z + 1)$ maps the disc onto the left half-plane with the upper and lower semi-circles mapping onto the positive and negative imaginary axes, respectively. In the left half-plane, $\operatorname{Arg} z = \operatorname{Im} \log z$ is harmonic with boundary values $\pi/2$

and $3\pi/2$, so that

$$\frac{3}{2} - \frac{\operatorname{Arg} z}{\pi}$$

has the desired boundary values. The solution to the given problem, then, is

$$u(z) = \frac{3}{2} - \frac{1}{\pi} \operatorname{Arg} \left(\frac{z-1}{z+1} \right).$$

◇

16.2 Liouville Theorems for $\operatorname{Re} f$; Zeroes of Entire Functions of Finite Order

The following theorem offers a formula, much like the Poisson Integral Formula, for the value of a C -analytic function in $D(0; R)$ in terms of its real part. This, in turn, will allow us to obtain estimates on the magnitude of an entire function from given bounds on its real part alone.

16.9 Theorem

If $f = u + iv$ is C -analytic in $D(0; R)$, then

$$f(z) = \frac{1}{2\pi} \int_0^{2\pi} u(Re^{i\theta}) \left[\frac{Re^{i\theta} + z}{Re^{i\theta} - z} \right] d\theta + iv(0).$$

Proof

We have already proven (following Theorem 16.7) that if $f = u + iv$ is C -analytic in $D(0; R)$ then

$$f(z) = \frac{1}{2\pi} \int_0^{2\pi} f(Re^{i\theta}) \operatorname{Re} \left[\frac{Re^{i\theta} + z}{Re^{i\theta} - z} \right] d\theta. \quad (1)$$

Moreover, as we noted in the proof of 16.8 (with $R = 1$)

$$g(z) = \frac{1}{2\pi} \int_0^{2\pi} u(Re^{i\theta}) \left[\frac{Re^{i\theta} + z}{Re^{i\theta} - z} \right] d\theta \quad (2)$$

is also analytic in $D(0; R)$. A comparison of (1) and (2) shows, however, that f and g have the same real parts

$$\operatorname{Re} f(z) = \operatorname{Re} g(z) = \frac{1}{2\pi} \int_0^{2\pi} u(Re^{i\theta}) \operatorname{Re} \left[\frac{Re^{i\theta} + z}{Re^{i\theta} - z} \right] d\theta.$$

Hence

$$f(z) = g(z) + i\lambda$$

or

$$f(z) = \frac{1}{2\pi} \int_0^{2\pi} u(Re^{i\theta}) \left[\frac{Re^{i\theta} + z}{Re^{i\theta} - z} \right] d\theta + i\lambda.$$

To determine λ , set $z = 0$. Then, by the Mean-Value Theorem (16.4), the integral on the right equals $u(0)$, so that

$$f(0) = u(0) + i\lambda$$

and

$$\lambda = v(0). \quad \square$$

Analogues of Liouville's Theorems for Re f. The original Liouville Theorem (5.10) states that a bounded entire function is constant. Note that the condition $|f| \leq M$ implies the four inequalities

$$\begin{aligned} -M &\leq \operatorname{Re} f \leq M \\ -M &\leq \operatorname{Im} f \leq M. \end{aligned}$$

However, according to the Weierstrass Theorem (9.6), any one of the four inequalities would suffice to prove that f is constant. For if any one of the inequalities is satisfied, the set of values assumed by f is not dense in the whole plane and f must be constant. The next theorem shows that the same reduction in hypothesis is possible for the Extended Liouville Theorem (5.11).

16.10 Theorem

If f is entire and any one of the four inequalities

$$\begin{aligned} -A|z|^n &\leq \operatorname{Re} f(z) \leq A|z|^n \\ -A|z|^n &\leq \operatorname{Im} f(z) \leq A|z|^n \end{aligned}$$

holds for sufficiently large z , then f is a polynomial of degree $\leq n$.

Proof

Without loss of generality, we may assume $\operatorname{Re} f(z) \leq A|z|^n$ for large z . (In the other cases, we could consider $-f$ or if .) Then applying 16.9 with $R = 2|z|$

$$\left| \frac{Re^{i\theta} + z}{Re^{i\theta} - z} \right| \leq 3$$

and

$$|f(z)| \leq \frac{3}{2\pi} \int_0^{2\pi} |u(Re^{i\theta})| d\theta + |f(0)|, \quad \text{where } u = \operatorname{Re} f.$$

To estimate the integral above, we set

$$u^+(\zeta) = \begin{cases} u(\zeta) & \text{if } u(\zeta) > 0 \\ 0 & \text{if } u(\zeta) \leq 0. \end{cases}$$

Then according to the hypothesis, if $|z|$ is large enough,

$$\frac{1}{2\pi} \int_0^{2\pi} u^+(Re^{i\theta}) d\theta \leq AR^n = A2^n |z|^n$$

and by the Mean-Value Theorem (16.4)

$$\frac{1}{2\pi} \int_0^{2\pi} u(Re^{i\theta}) d\theta = u(0).$$

By the lemma below

$$\frac{1}{2\pi} \int_0^{2\pi} |u(Re^{i\theta})| d\theta \leq A2^{n+1} |z|^n + |u(0)|$$

so that

$$|f(z)| \leq A_1 |z|^n + A_2$$

and by the Extended Liouville Theorem, f is a polynomial of degree at most n . \square

16.11 Lemma

Let g be real-valued and continuous on $[a, b]$. If $\int_a^b g(x) dx = \alpha$ and if

$$\int_a^b g^+(x) dx \leq \beta,$$

then

$$\int_a^b |g(x)| dx \leq 2\beta + |\alpha|.$$

Proof

Recall that

$$g^+(x) = \begin{cases} g(x) & \text{if } g(x) > 0 \\ 0 & \text{if } g(x) \leq 0. \end{cases}$$

If we set

$$g^-(x) = \begin{cases} -g(x) & \text{if } g(x) < 0 \\ 0 & \text{if } g(x) \geq 0, \end{cases}$$

then

$$g = g^+ - g^-$$

and

$$|g| = g^+ + g^-.$$

By hypothesis

$$\int_a^b g^+(x) dx \leq \beta$$

and

$$\int_a^b g^-(x) dx = \int_a^b g^+(x) dx - \alpha \leq \beta - \alpha,$$

so that

$$\int_a^b |g(x)| dx \leq 2\beta - \alpha \leq 2\beta + |\alpha|. \quad \square$$

16.12 Definition

An entire function f is said to be of *finite order* if for some k and some $R > 0$, $|f(z)| \leq \exp(|z|^k)$ for all z with $|z| \geq R$.

Theorem 16.10 can be used to prove the existence of zeroes for many entire functions of finite order. To show, for example, that $e^z - z$ must have a zero, we first assume that $e^z - z \neq 0$. Then $g(z) = \log(e^z - z)$ would be entire with

$$\operatorname{Re}(g(z)) = \log|e^z - z| \leq |z| + 1 \text{ for } |z| \geq e.$$

But then, according to Theorem 16.10, g would be a linear polynomial; that is,

$$\log(e^z - z) = az + b$$

or

$$e^z - z = e^{az+b}.$$

Expanding both sides in power series would lead us to conclude

$$1 + \frac{z^2}{2!} + \frac{z^3}{3!} + \cdots = e^b \left(1 + az + a^2 \frac{z^2}{2!} + \cdots \right),$$

which is impossible.

Similarly, we can show that $e^z - z$ must have *infinitely* many zeroes. For if $e^z - z$ had only finitely many zeroes $\alpha_1, \alpha_2, \dots, \alpha_N$, we could apply the above argument to

$$(e^z - z)/(z - \alpha_1)(z - \alpha_2) \dots (z - \alpha_N)$$

to conclude that

$$e^z - z = (z - \alpha_1)(z - \alpha_2) \dots (z - \alpha_N)e^{az+b}. \quad (3)$$

By considering the growth of both sides as $z \rightarrow \infty$, however, it is easily seen that (3) cannot hold.

16.13 Theorem

Suppose f is an entire function of finite order. Then either f has infinitely many zeroes or

$$f(z) = Q(z)e^{P(z)}$$

where Q and P are polynomials.

Proof

Suppose f has a finite number of zeroes, $\alpha_1, \dots, \alpha_k$. Then we may write

$$f(z) = Q(z)g(z)$$

where

$$Q(z) = (z - \alpha_1) \cdots (z - \alpha_k)$$

and g is an entire function that is never zero. Thus we can define an entire function

$$P(z) = \log g(z),$$

which by our hypothesis must satisfy

$$|\operatorname{Re} P(z)| \leq |z|^k \quad \text{for } |z| \geq R$$

for some k and R . Hence P is a polynomial and $f(z) = Q(z)e^{P(z)}$, as desired. \square

An entire function does not have to assume every value in the complex plane. However, according to Theorem 16.13, *if f is of finite order*, and if $f(z) \neq a$ for all z , then

$$f(z) - a = e^{P(z)}$$

It follows that f assumes every *other* complex value b infinitely often since P assumes each of the infinitely many values of $\log(b - a)$.

The Little Picard Theorem asserts that the above is true for *all* entire functions. While a proof of this theorem would take us too far afield, we can prove that it is true for a very broad class of functions. Let $E_1(z) = \exp(z^k)$ for any fixed positive integer k , and let $E_{n+1}(z) = \exp(E_n(z))$, so that E_j is the j -fold exponential of z^k . We will show that Picard's Theorem is applicable to any entire function which grows no faster than E_j for some j . To be precise, we will say that f is of j -fold exponential order if, for some $R > 0$, the j -fold logarithm: $\log(\log(\log \cdots (|f(z)|))) < |z|^k$, for some fixed k and $|z| > R$. Note that if f is of j -fold exponential order, then $\log f$ is of $(j - 1)$ -fold exponential order.

16.14 Theorem

Suppose f is an entire function of j -fold exponential order, for some j . Then, if $f(z) \neq a$ for all z , f assumes every other complex value b infinitely often.

Proof

If $j = 1$, f is of finite order and the result follows, as indicated above. To complete the proof, assume that f is of $(j + 1)$ -fold exponential order. Then $g(z) = \log(f(z) - a)$ would be of j -fold exponential order, and by induction we can assume that g assumes every value in the complex plane with at most one exception. In particular, g assumes

all of the infinitely many values of $\log(b - a)$ with at most one exception. But then, since $f(z) = a + e^{g(z)}$, f assumes every complex value $b \neq a$ infinitely often. \square

We leave it as an exercise to show that Theorem 16.14 is not equivalent to Picard's Little Theorem. That is, there are entire functions which are not of j -fold exponential order, for any j .

Exercises

1. Suppose $f = u + iv$ is analytic. Show then that $u + v$ and uv are harmonic.
2. Show that every partial derivative of a harmonic function is itself harmonic.
3. Show that u^2 cannot be harmonic for any nonconstant harmonic function u .
4. Show that $\log(x^2 + y^2)$ is harmonic in $z \neq 0$ but is not equal to the real part of a function that is analytic in $z \neq 0$.
5. a. Show that if $u(r, \theta)$ is dependent on r alone, Laplace's equation becomes

$$u_{rr} + \frac{1}{r}u_r = 0.$$

- b. Use the above to show that a harmonic function which depends on r alone must have the form $u(r, \theta) = a \log r + b$.
6. Derive the Poisson Formula

$$u(x + iy) = \frac{1}{\pi} \int_{-\infty}^{\infty} \frac{y \cdot u(t) dt}{(t - x)^2 + y^2} \quad (\text{I})$$

for a bounded C -harmonic function in the upper half-plane. [Hint: Let C_R denote the indicated contour and set

$$2\pi if(z) = \int_{C_R} \frac{f(\zeta)}{\zeta - z} d\zeta - \int_{C_R} \frac{f(\zeta)}{\zeta - \bar{z}} d\zeta,$$

where $\text{Re } f = u$. Then simplify and obtain (I) for $f(x + iy)$ by letting $R \rightarrow \infty$.]

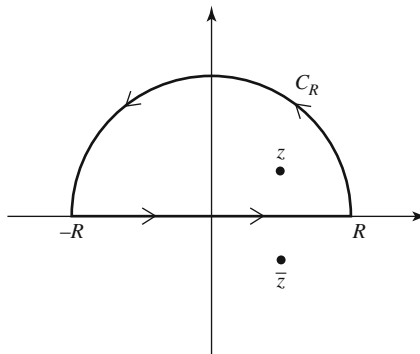

7. Find a harmonic function in $D(0; 1)$ with boundary values $u(x, y) = x^3$.
8. Let u be harmonic in $D(0; 1)$ with boundary values: 1 on the upper semi-circle and 0 on the lower semi-circle. Show that the level curves $u(x, y) = k$, $0 \leq k \leq 1$, are all circular segments.

9. Find a harmonic function u in the upper half-plane with

$$\lim_{y \rightarrow 0} u(x, y) = \begin{cases} 0, & x < 0 \\ 1, & x > 0 \end{cases}$$

10. Find the temperature function $u(x, y)$ for a solid represented by the semi-infinite strip

$$-\frac{\pi}{2} \leq x \leq \frac{\pi}{2}, \quad y \geq 0$$

given that $u(x, 0) = 1$, $-\frac{\pi}{2} < x < \frac{\pi}{2}$,

$$u\left(-\frac{\pi}{2}, y\right) = 2, \text{ and } u\left(\frac{\pi}{2}, y\right) = 0, \text{ for } y > 0.$$

11. Prove $e^z - P(z)$ and $\sin z - P(z)$ have infinitely many zeroes for every non-zero polynomial P .
 12. We say an entire function of finite order has order j if

$$j = \inf \left\{ k : \lim_{z \rightarrow \infty} \frac{f(z)}{\exp(|z|^k)} = 0 \right\}.$$

Prove that the only non-vanishing entire functions of order j are of the form $f(z) = e^{P_j(z)}$, where P_j is a polynomial of degree j .

- 13.* Show that $\sin z - z = c$ has a solution for every complex number c by showing that if $\sin z - z \neq c$ for all z , then $\sin z - z \neq c + 2\pi$
 14.* Let $f_0(z) = z$, $f_{n+1}(z) = e^{f_n(z)}$, $n = 0, 1, 2, \dots$ and let $g_0(t) = t$, $g_{n+1}(t) = t^{g_n(t)}$. Define

$$F(z) = \sum_{k=0}^{\infty} \frac{f_k(z)}{g_k(k)}$$

Show that $F(z)$ is an entire function but $F(z)$ is not of j -fold exponential order for any positive integer j .

Chapter 17

Different Forms of Analytic Functions

Introduction

The analytic functions we have encountered so far have generally been defined either by power series or as a combination of the elementary polynomial, trigonometric and exponential functions, along with their inverse functions. In this chapter, we consider three different ways of representing analytic functions. We begin with infinite products and then take a closer look at functions defined by definite integrals, a topic touched upon earlier in Chapter 7 and in Chapter 12.2. Finally, we define Dirichlet series, which provide a link between analytic functions and number theory.

17.1 Infinite Products

17.1 Definition

- Let $\{u_k\}_{k=1}^{\infty}$ be a sequence of nonzero complex numbers. The infinite product $\prod_{k=1}^{\infty} u_k$ is said to converge if the sequence of partial products $P_N = u_1 u_2 \dots u_N$ converges to a nonzero limit as $N \rightarrow \infty$. If $P_N \rightarrow 0$, we say the infinite product *diverges* to 0.
- If finitely many terms u_k are equal to zero, we will say the product converges to zero provided $\prod_{\substack{k=1 \\ u_k \neq 0}}^{\infty} u_k$ converges.

EXAMPLES

- $\prod_{k=1}^{\infty} (1 + 1/k) = \frac{2}{1} \cdot \frac{3}{2} \cdot \frac{4}{3} \cdot \dots$ diverges (to ∞) since $P_N = N + 1 \rightarrow \infty$.
- $\prod_{k=2}^{\infty} (1 - 1/k)$ diverges to zero.
- $\prod_{k=2}^{\infty} (1 - 1/k^2) = \prod_{k=2}^{\infty} (k-1)(k+1)/k^2$ converges.
We leave it as an exercise to prove this by finding an explicit formula for P_N .
- $\prod_{k=1}^{\infty} (1 - 1/k^2)$ converges to 0 since $\prod_{k=2}^{\infty} (1 - 1/k^2)$ converges. \diamond

Notes

1. If $P_{N-1} \neq 0$,

$$u_N = \frac{P_N}{P_{N-1}}.$$

Hence if $\prod_{k=1}^{\infty} u_k$ converges, $u_N \rightarrow 1$ as $N \rightarrow \infty$. For this reason, we will usually write infinite products in the form $\prod_k (1 + z_k)$ with the understanding that $z_k \rightarrow 0$ if the product converges.

2. If $\{a_k\}_{k=1}^{\infty}$ is a sequence of positive real numbers, $\prod_{k=1}^{\infty} (1 + a_k)$ converges if and only if $\sum_{k=1}^{\infty} a_k$ converges. This follows from the inequalities

$$a_1 + a_2 + \cdots + a_N \leq \prod_{k=1}^N (1 + a_k) \leq e^{a_1 + a_2 + \cdots + a_N}.$$

The right-hand inequality is a direct consequence of the fact that $1 + x \leq e^x$ for all real x . It is not true for complex numbers z_k , however, that $\prod_{k=1}^{\infty} (1 + z_k)$ converges if and only if $\sum_{k=1}^{\infty} z_k$ converges (see Exercise 5), but we do have the following theorem.

17.2 Proposition

Let $z_k \neq -1$, $k = 1, 2, \dots$. $\prod_{k=1}^{\infty} (1 + z_k)$ converges if and only if $\sum_{k=1}^{\infty} \log(1 + z_k)$ converges. ($\log z$ here denotes the principal branch of the logarithm; i.e., $-\pi < \text{Im } \log z = \text{Arg } z \leq \pi$.)

Proof

Let $S_N = \sum_{k=1}^N \log(1 + z_k)$. Then $P_N = e^{S_N}$ and if $S_N \rightarrow S$, $P_N \rightarrow P = e^S$. Suppose, on the other hand, that $P_N \rightarrow P \neq 0$. Then, some branch of the logarithm (which we will denote \log^*) is continuous at P and $\log^* P_N \rightarrow \log^* P$ as $N \rightarrow \infty$. Suppose we inductively define integers n_k so that

$$\sum_{k=1}^N (\log(1 + z_k) + 2\pi i n_k) = \log^* P_N.$$

Then since $\log^* P_N$ converges,

$$\sum_{k=1}^N (\log(1 + z_k) + 2\pi i n_k)$$

converges; therefore $\log(1 + z_k) + 2\pi i n_k \rightarrow 0$ as $k \rightarrow \infty$. Since $z_k \rightarrow 0$ and \log denotes the principal branch, it follows that $n_k = 0$ for k sufficiently large.

Hence $\sum_{k=1}^{\infty} \log(1 + z_k)$ converges. \square

17.3 Proposition

If $\sum_{k=1}^{\infty} |z_k|$ converges, $\prod_{k=1}^{\infty} (1 + z_k)$ converges.

Proof

Assume $\sum_{k=1}^{\infty} |z_k|$ converges and take N such that for $k > N$, $|z_k| < \frac{1}{2}$. Then, for $k > N$

$$|\log(1 + z_k)| = \left| z_k - \frac{z_k^2}{2} + \frac{z_k^3}{3} - + \cdots \right| \leq |z_k| \left(1 + \frac{1}{2} + \frac{1}{4} + \cdots \right) \leq 2|z_k|.$$

Hence $\sum_{k=N+1}^{\infty} \log(1 + z_k)$ is convergent and by the previous proposition so is $\prod_{k=1}^{\infty} (1 + z_k)$. \square

17.4 Definition

$\prod_{k=1}^{\infty} (1 + z_k)$ is called *absolutely convergent* if

$$\prod_{k=1}^{\infty} (1 + |z_k|) \text{ converges.}$$

17.5 Proposition

An absolutely convergent product is convergent.

Proof

According to Note (2) (following Definition 17.1), the convergence of $\prod_{k=1}^{\infty} (1 + |z_k|)$ is equivalent to the convergence of $\sum_{k=1}^{\infty} |z_k|$. Hence if $\prod_{k=1}^{\infty} (1 + |z_k|)$ converges so does $\sum_{k=1}^{\infty} |z_k|$ and by the previous proposition, so does $\prod_{k=1}^{\infty} (1 + z_k)$. \square

We wish to consider analytic functions defined by infinite products; i.e., functions of the form

$$f(z) = \prod_{k=1}^{\infty} (1 + u_k(z)).$$

Recall that f is analytic if each function u_k , $k = 1, 2, \dots$ is analytic and the partial products converge to their limit function uniformly on compacta (Theorem 7.6).

17.6 Theorem

Suppose that $u_k(z)$ is analytic in a region D for $k = 1, 2, \dots$, and that $\sum_{k=1}^{\infty} |u_k(z)|$ converges uniformly on compacta. Then the product $\prod_{k=1}^{\infty} (1 + u_k(z))$ converges uniformly on compacta and represents an analytic function in D .

Proof

Let A be a compact subset of D . Since $\sum_{k=1}^{\infty} |u_k(z)|$ converges uniformly on A , for sufficiently large k , $|u_k(z)| < 1$ there. Hence, we may assume that $1 + u_k \neq 0$ for all k . If we then take N large enough so that $\sum_{k=N+1}^{\infty} |u_k(z)| < \epsilon/2$, it follows, as in

the proof of Proposition 17.3, that

$$\left| \sum_{k=N+1}^{\infty} \log(1 + u_k(z)) \right| \leq \epsilon \text{ throughout } A.$$

That is, $\sum_{k=1}^{\infty} \log(1 + u_k(z))$ converges uniformly on A to a limit function $S(z)$. It follows that $S(A)$ is bounded. Finally, since the exponential function is uniformly continuous in any bounded domain,

$$P_N(z) = \exp\left(\sum_{k=1}^N \log(1 + u_k(z))\right)$$

converges uniformly to its limit function $e^{S(z)}$. \square

EXAMPLES

1. $\prod_{k=1}^{\infty} (1 + z^k)$ converges uniformly on any compact subset of the unit disc since any compact subset is contained in a disc of radius $\delta < 1$. Hence

$$\sum_{k=1}^{\infty} |z^k| \leq \sum_{k=1}^{\infty} \delta^k = \frac{\delta}{1 - \delta}$$

and, by the M -test, $\sum_{k=1}^{\infty} |z^k|$ is uniformly convergent.

2.

$$\prod_{k=1}^{\infty} \left(1 + \frac{1}{k^z}\right)$$

represents an analytic function in the half-plane $D : \operatorname{Re} z > 1$. In any compact subset of D , $\operatorname{Re} z \geq 1 + \delta$ throughout so that

$$\left| \frac{1}{k^z} \right| = \frac{1}{k^{\operatorname{Re} z}} \leq \frac{1}{k^{1+\delta}}, \quad k = 1, 2, \dots$$

Hence

$$\sum_{k=1}^{\infty} \left| \frac{1}{k^z} \right|$$

and, consequently,

$$\prod_{k=1}^{\infty} \left(1 + \frac{1}{k^z}\right)$$

are uniformly convergent. \diamond

The Weierstrass Product Theorem. According to the Uniqueness Theorem (6.9), a nontrivial entire function cannot have an accumulation point of zeroes. That is, if $\{\lambda_k\} \rightarrow \lambda$ and if f is an entire function with zeroes at all the points λ_k , then $f \equiv 0$. On the other hand, an entire function may be zero at all the points of a sequence which

diverges to ∞ . For example $\sin z$ is zero at all integral multiples of π . Similarly, $e^z - 1$ is zero at all the integral multiples of $2\pi i$. The Weierstrass Product Theorem shows that these examples are in no way exceptional.

17.7 Theorem (Weierstrass)

Suppose $\{\lambda_k\}_{k=1}^\infty \rightarrow \infty$. Then there exists an entire function f such that $f(z) = 0$ if and only if $z = \lambda_k, k = 1, 2, \dots$

Note: To define an entire function with zeroes at the points λ_k , it would seem natural to write

$$f(z) = \prod_{k=1}^\infty (z - \lambda_k).$$

However, since $\lambda_k \rightarrow \infty$, the terms of the product would not approach 1 (for fixed z) and hence the product would diverge. Instead, we consider the infinite product of linear functions given by

$$f(z) = \prod_{k=1}^\infty \left(1 - \frac{z}{\lambda_k}\right),$$

assuming for now that $\lambda_k \neq 0$. Indeed, if $\sum_{k=1}^\infty |1/\lambda_k|$ converges, $\sum_{k=1}^\infty |z/\lambda_k|$ converges uniformly on every compact set so that the product is uniformly convergent on compacta and gives the desired entire function. Moreover, if $\sum_{k=1}^\infty 1/|\lambda_k|$ diverges but $\sum_{k=1}^\infty 1/|\lambda_k|^2$ converges, we can modify the above construction by considering

$$f(z) = \prod_{k=1}^\infty \left[\left(1 - \frac{z}{\lambda_k}\right) e^{z/\lambda_k} \right].$$

With the ‘‘convergence factors’’ e^{z/λ_k} , the product is uniformly convergent on compacta since, for $|\lambda_k| > 2|z|$,

$$\begin{aligned} \left| \log \left[\left(1 - \frac{z}{\lambda_k}\right) e^{z/\lambda_k} \right] \right| &= \left| \left(-\frac{z}{\lambda_k} - \frac{z^2}{2\lambda_k^2} - \frac{z^3}{3\lambda_k^3} + \dots \right) + \frac{z}{\lambda_k} \right| \\ &\leq \left| \frac{z^2}{\lambda_k^2} \right| \left(\frac{1}{2} + \frac{1}{4} + \frac{1}{8} \dots \right) = \left| \frac{z^2}{\lambda_k^2} \right|. \end{aligned}$$

Hence the series

$$\sum_{k=1}^\infty \log \left[\left(1 - z/\lambda_k\right) e^{z/\lambda_k} \right], \quad z \neq \lambda_k$$

is uniformly convergent and the product is uniformly convergent on compacta.

By the same reasoning, if $\sum_{k=1}^\infty 1/|\lambda_k|^{m+1}$ converges for some positive integer m and we consider the convergence factors

$$E_k(z) = \exp \left(z/\lambda_k + z^2/2\lambda_k^2 + \dots + z^m/m\lambda_k^m \right),$$

it follows that the infinite product

$$\prod_{k=1}^{\infty} \left(1 - \frac{z}{\lambda_k}\right) E_k(z)$$

is uniformly convergent on compacta and represents an entire function with the desired zeroes. There are sequences $\{\lambda_k\}$, however, such that $\lambda_k \rightarrow \infty$ and yet $\sum_{k=1}^{\infty} 1/|\lambda_k|^N$ diverges for all N . (For example, $\{\lambda_k\} = \{\log k\}_{k=2}^{\infty}$.) Hence, for the general case we must introduce a slight variation.

Proof

Assume for the moment that $\lambda_k \neq 0$ and set

$$E_k(z) = \exp\left(\frac{z}{\lambda_k} + \frac{z^2}{2\lambda_k^2} + \cdots + \frac{z^k}{k\lambda_k^k}\right).$$

Suppose, moreover, that $|z| < M$. Then since $\lambda_k \rightarrow \infty$, for sufficiently large k , $|\lambda_k| > 2|z|$ and

$$\left| \log \left[\left(1 - \frac{z}{\lambda_k}\right) E_k(z) \right] \right| \leq \sum_{j=k+1}^{\infty} \left| \frac{z^j}{j\lambda_k^j} \right| \leq \left| \frac{z}{\lambda_k} \right|^k \leq \frac{1}{2^k}.$$

Hence both

$$\sum_{k=1}^{\infty} \log \left[\left(1 - \frac{z}{\lambda_k}\right) E_k(z) \right] \text{ and } \prod_{k=1}^{\infty} \left[\left(1 - \frac{z}{\lambda_k}\right) E_k(z) \right]$$

are uniformly convergent on compacta. Note also that the individual factors are zero only at the points λ_k , and by the definition of convergence the infinite product is zero at those points only. Finally, if we seek an entire function with zeroes at the origin as well, we need only set

$$f(z) = z^P \prod_{k=1}^{\infty} \left[\left(1 - \frac{z}{\lambda_k}\right) E_k(z) \right].$$

□

EXAMPLES

1. To find an entire function f with a single zero at every negative integer $\lambda_k = -k$, note that $\sum_{k=1}^{\infty} 1/|\lambda_k|$ diverges but $\sum_{k=1}^{\infty} 1/|\lambda_k|^2$ converges so that we can define

$$f(z) = \prod_{k=1}^{\infty} \left(1 + \frac{z}{k}\right) e^{-z/k}.$$

2. An entire function with zeroes at all the points $\lambda_k = \log k$, $k = 1, 2, \dots$, is given by

$$f(z) = z \prod_{k=2}^{\infty} \left[\left(1 - \frac{z}{\log k} \right) \exp \left(\frac{z}{\log k} + \frac{z^2}{2 \log^2 k} + \dots + \frac{z^k}{k \log^k k} \right) \right].$$

3. An entire function with a single zero at every integer is given by

$$f(z) = z \prod_{k=1}^{\infty} \left[\left(1 - \frac{z}{k} \right) e^{z/k} \left(1 + \frac{z}{k} \right) e^{-z/k} \right] = z \prod_{k=1}^{\infty} \left(1 - \frac{z^2}{k^2} \right). \quad \diamond$$

17.8 Proposition

Let

$$f(z) = z \prod_{k=1}^{\infty} \left(1 - \frac{z^2}{k^2} \right).$$

Then $f(z) = (\sin \pi z)/\pi$.

Proof

Consider the quotient

$$Q(z) = z \prod_{k=1}^{\infty} \left(1 - \frac{z^2}{k^2} \right) / \sin \pi z.$$

Q is entire and zero-free. To show that Q is constant we seek estimates on its growth for large z . Assume then that $\frac{1}{2}N \leq |z| \leq N$. Then $|Q(z)|$ is bounded by the maximum value assumed by Q on the square of side $2N + 1$ centered at the origin (Theorem 6.13). We have already proved, however, (see Chapter 11.2) that along this square (which avoids the zeroes of $\sin \pi z$), $|1/\sin \pi z| \leq 4$. Moreover,

$$\begin{aligned} \left| \prod_{k=1}^{\infty} \left(1 - \frac{z^2}{k^2} \right) \right| &= \left| \prod_{k=1}^N \left(1 - \frac{z}{k} \right) \left(1 + \frac{z}{k} \right) \prod_{k=N+1}^{\infty} \left(1 - \frac{z^2}{k^2} \right) \right| \\ &\leq \prod_{k=1}^N e^{2|z|/k} \prod_{k=N+1}^{\infty} e^{|z^2|/k^2} \\ &\leq \exp \left(2|z|(1 + \log N) + \frac{|z^2|}{N} \right) \end{aligned}$$

since

$$\sum_{k=1}^N \frac{1}{k} < 1 + \log N \quad \text{and} \quad \sum_{k=N+1}^{\infty} \frac{1}{k^2} < \frac{1}{N}.$$

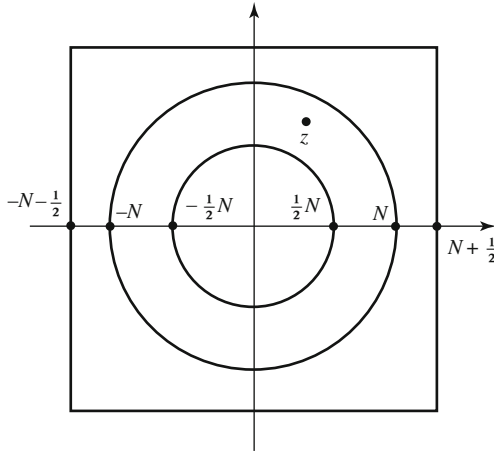

Noting again that for large N , $2(1 + \log N) < \sqrt{N/2} \leq |z|^{1/2}$ while $|z^2|/N \leq |z|$, it follows that

$$|Q(z)| = \left| \frac{z \prod_{k=1}^{\infty} \left(1 - \frac{z^2}{k^2}\right)}{\sin \pi z} \right| \leq A \exp(|z|^{3/2}).$$

By Theorem 16.12, then, we must have

$$\frac{z \prod_{k=1}^{\infty} \left(1 - \frac{z^2}{k^2}\right)}{\sin \pi z} = A e^{Bz}.$$

However, Q is an even function so that $B = 0$, and the constant A can be determined by noting that

$$A = Q(0) = \lim_{z \rightarrow 0} \frac{z}{\sin \pi z} = \frac{1}{\pi}.$$

□

Some consequences of the above proposition:

i. Setting $z = \frac{1}{2}$, we have

$$1 = \frac{\pi}{2} \prod_{k=1}^{\infty} \left[1 - \frac{1}{(2k)^2}\right]$$

so that

$$\frac{2}{\pi} = \left(\frac{1 \cdot 3}{2 \cdot 2}\right) \left(\frac{3 \cdot 5}{4 \cdot 4}\right) \left(\frac{5 \cdot 7}{6 \cdot 6}\right) \dots$$

or

$$\pi = 2 \cdot \left(\frac{2 \cdot 2}{1 \cdot 3}\right) \left(\frac{4 \cdot 4}{3 \cdot 5}\right) \left(\frac{6 \cdot 6}{5 \cdot 7}\right) \dots$$

- ii. Suppose we expand the terms in the product to obtain an infinite series. Then we will have

$$\begin{aligned}\sin \pi z &= \pi z \prod_{k=1}^{\infty} \left(1 - \frac{z^2}{k^2}\right) \\ &= \pi z \left[1 - \left(\sum_{k=1}^{\infty} \frac{1}{k^2}\right) z^2 + 2 \left(\sum_{k,j} \frac{1}{k^2 j^2}\right) z^4 - + \dots\right].\end{aligned}$$

A comparison with the familiar power series

$$\sin \pi z = \pi z - \frac{\pi^3 z^3}{6} + \frac{\pi^5 z^5}{120} - + \dots$$

shows that

$$\sum_{k=1}^{\infty} \frac{1}{k^2} = \frac{\pi^2}{6}.$$

(See 11.2 for an earlier proof of this identity.)

17.2 Analytic Functions Defined by Definite Integrals

We noted previously that Morera's Theorem (7.4) can be used to prove the analyticity of certain functions given in integral form. We now examine this notion in somewhat greater detail.

17.9 Theorem

Suppose $\varphi(z, t)$ is a continuous function of t , $a \leq t \leq b$, for fixed z and an analytic function of $z \in D$ for fixed t . Then

$$f(z) = \int_a^b \varphi(z, t) dt$$

is analytic in D and

$$f'(z) = \int_a^b \frac{\partial}{\partial z} (\varphi(z, t)) dt. \quad (1)$$

Proof

Since f is a continuous function of z , according to Morera's Theorem (7.4), we need only prove that $\int_{\Gamma} f(z) dz = 0$ for any rectangle $\Gamma \subset D$. We can reverse the order of integration, however, and write

$$\int_{\Gamma} f(z) dz = \int_{\Gamma} \left(\int_a^b \varphi(z, t) dt \right) dz = \int_a^b \left(\int_{\Gamma} \varphi(z, t) dz \right) dt$$

since φ is continuous in t and in z . Thus, since φ is analytic in z ,

$$\int_{\Gamma} f(z) dz = \int_a^b 0 dt = 0$$

We leave it as an exercise to show that f' is given by the formula in (1). \square

EXAMPLES

1. $f(z) = \int_0^1 dt/(t - z)$ is analytic in $D = \mathbb{C} \setminus [0, 1]$.

In fact, direct integration shows that $f(z) = \log(1 - 1/z)$, and we can use Theorem 10.8 to show that f is analytic in D . Recall then that $\Delta \text{Arg}(1 - 1/z)$, as z traverses a closed curve, gives the number of zeroes minus the number of poles of $1 - 1/z$ that lie inside the curve. Yet if the curve is a simple closed curve encircling the interval $[0, 1]$, because $1 - 1/z$ has one zero and one pole inside, $\Delta \text{Arg}(1 - 1/z) = 0$. The same argument shows that f has a jump discontinuity of $2\pi i$ as z crosses through any point x , $0 < x < 1$ from the upper to the lower half-plane.

2. $g(z) = \int_0^{\infty} dt/(e^t - z)$ is analytic in $\mathbb{C} \setminus [1, \infty)$. Although g is given by an improper integral, it is the uniform limit of

$$g_N(z) = \int_0^N \frac{dt}{e^t - z}$$

on any compact subset of $\mathbb{C} \setminus [1, \infty)$, and hence g is analytic. As we shall see below, g has a “jump” of $2\pi i/x$ as z crosses from the upper half-plane to the lower half-plane through any point $x > 1$. \diamond

17.10 Proposition

Suppose that f and g are continuous real-valued functions on $[a, b]$ and that $f' > 0$ is also continuous. Then

$$F(z) = \int_a^b \frac{g(t)}{f(t) - z} dt$$

is analytic outside the interval $[\alpha, \beta]$ where $\alpha = f(a)$, $\beta = f(b)$ and

$$\lim_{y \rightarrow 0^+} [F(x + iy) - F(x - iy)] = 2\pi i \frac{g(f^{-1}(x))}{f'(f^{-1}(x))} \text{ for all } x \in (\alpha, \beta).$$

Proof

The analyticity of F is proven in Theorem 17.9. By rationalizing the denominator, we obtain

$$F(x + iy) = \int_a^b \frac{[f(t) - x]g(t)}{[f(t) - x]^2 + y^2} dt + iy \int_a^b \frac{g(t)dt}{[f(t) - x]^2 + y^2}.$$

Hence

$$F(x + iy) - F(x - iy) = 2iy \int_a^b \frac{g(t)dt}{[f(t) - x]^2 + y^2},$$

and setting $t = f^{-1}(u)$, $\alpha = f(a)$, $\beta = f(b)$

$$F(x + iy) - F(x - iy) = 2i \int_\alpha^\beta \frac{yg(f^{-1}(u))du}{f'(f^{-1}(u))[(u - x)^2 + y^2]}.$$

We leave it as an exercise to complete the proof by showing that

$$\int_\alpha^\beta \frac{h(u)y}{(u - x)^2 + y^2} du \rightarrow \pi h(x)$$

as $y \rightarrow 0$ for any continuous function h on $[\alpha, \beta]$ and $\alpha < x < \beta$. □

17.3 Analytic Functions Defined by Dirichlet Series

Series of the form

$$\sum_{n=1}^{\infty} \frac{a_n}{n^z}$$

are known as Dirichlet Series. Note that $n^{-z} = \exp(-z \log n)$ represents an entire function for every positive integer n . ($\log n$ is chosen as the principal value; i.e., $\log n$ is real-valued, so n^{-z} is positive for all real z . The coefficients a_n , of course, can be any complex constants.) Since the partial sums are entire, a function $f(z)$, defined by a Dirichlet series, is analytic in any region where the series converges uniformly. According to the theorems below, the natural regions of convergence for Dirichlet series are half-planes of the form $\operatorname{Re} z > x_0$, much as discs centered at the origin are the natural regions associated with power series.

17.11 Theorem

If $\sum_{n=1}^{\infty} \frac{a_n}{n^z}$ converges for $z = z_0$, then it converges for all z in the half-plane $H = \{z : \operatorname{Re} z > \operatorname{Re} z_0\}$. Moreover, the convergence is uniform in any compact subset of H .

Proof

To show that $\sum_{n=1}^{\infty} \frac{a_n}{n^z}$ converges, we will show that the partial sums form a Cauchy sequence. That is, we will show that

$$\left| \sum_{n=M}^N \frac{a_n}{n^z} \right| = \left| \frac{a_M}{M^z} + \cdots + \frac{a_N}{N^z} \right|$$

is arbitrarily small for sufficiently large values of M .

Our proof is based on “summation by parts” and the following two observations:

(i) Since

$$\sum_{n=1}^{\infty} \frac{a_n}{n^{z_0}}$$

converges, there exists a positive constant A with

$$\left| \sum_{n=1}^T \frac{a_n}{n^{z_0}} \right| < A \quad (2)$$

for all positive integers T .

(ii)

$$\left| \frac{1}{n^w} - \frac{1}{(n+1)^w} \right| < \frac{|w|}{n^{\operatorname{Re} w + 1}}$$

The above inequality follows easily from the usual $M - L$ formula, since

$$\frac{1}{n^w} - \frac{1}{(n+1)^w} = \int_n^{n+1} w t^{-w-1} dt.$$

To complete the proof, let

$$A_n = \sum_{k=1}^n \frac{a_k}{k^{z_0}}, \quad b_n = \frac{1}{n^w}, \quad \text{with } w = z - z_0.$$

Then

$$\begin{aligned} \frac{a_M}{M^z} + \cdots + \frac{a_N}{N^z} &= (A_M - A_{M-1})b_M + \cdots + (A_N - A_{N-1})b_N \\ &= -A_{M-1}b_M + \sum_{k=M}^{N-1} A_k(b_k - b_{k+1}) + A_N b_N. \end{aligned} \quad (3)$$

$-A_{M-1}b_M$ and $A_N b_N$ both go to zero for sufficiently large values of M and N , since

$$|A_k| < A \text{ for all } k, \quad \text{and} \quad |b_n| = 1/n^{\operatorname{Re}(z-z_0)}$$

The remaining sum on the right side of (3) is also arbitrarily small for sufficiently large M since, according to (i) and (ii), it is bounded in absolute value by

$$\sum_{k=M}^{\infty} \frac{A|z - z_0|}{k^{1+\delta}}, \quad \text{where } \delta = \operatorname{Re}(z - z_0),$$

which is the “tail” of a convergent series. Hence

$$\sum_{n=1}^{\infty} \frac{a_n}{n^z}$$

converges.

Finally, note that if K is a compact subset of H , there is a positive value of δ , with $\operatorname{Re}(z - z_0) > \delta$ for all z in K , as well as a positive constant B with $|z| < B$ throughout K . Hence the expression in (3) will have a uniformly small absolute value for all z in K , once M is sufficiently large. So the series converges to its limit function uniformly in K . \square

Note that in the proof of Theorem 17.11, we never actually used the convergence of the Dirichlet series at z_0 . The only actual requirement for the conclusion was that there was a finite upper bound for the absolute value of its partial sums.

EXAMPLE

Suppose $a_n = (-1)^n$. Then $\sum_{n=1}^{\infty} \frac{a_n}{n^z}$ has bounded partial sums (although it diverges) at $z = 0$. According to Theorem 17.11, then, it converges and represents an analytic function in the right half-plane: $\operatorname{Re} z > 0$. The fact that it diverges at $z = 0$ also implies that its partial sums are not bounded for any value of z with a negative real part. \diamond

17.12 Theorem

If $\sum_{n=1}^{\infty} \frac{a_n}{n^z}$ converges for some, but not all, values of z , there exists a real constant x_0 (called the abscissa of convergence) such that $\sum_{n=1}^{\infty} \frac{a_n}{n^z}$ converges if $\operatorname{Re} z > x_0$ and diverges if $\operatorname{Re} z < x_0$.

Proof

Let x_0 be the greatest lower bound of the real parts of all the complex numbers z for which $\sum_{n=1}^{\infty} \frac{a_n}{n^z}$ converges. By Theorem 17.11, if $x_0 = -\infty$, the series converges for all z . If the series neither converges for all z nor diverges for all z , $-\infty < x_0 < \infty$ and the theorem follows from Theorem 17.11 \square

The abscissa of convergence of the Dirichlet series bears an obvious analogy to the radius of convergence of a power series. However, the analogy does not extend to the idea of absolute convergence. Power series converge absolutely in any compact subset of their region of convergence. On the other hand, consider the Dirichlet series

$$\sum_{n=1}^{\infty} \frac{(-1)^n}{n^z}$$

As we mentioned above, the series converges (and represents an analytic function) in the right half-plane: $\operatorname{Re} z > 0$. However, it converges absolutely only if $\operatorname{Re} z > 1$.

This is the general situation with Dirichlet series. In addition to the half-plane of convergence H , there is a half-plane of absolute convergence H_1 , which may be a proper subset of H .

17.13 Theorem

Suppose $\sum_{n=1}^{\infty} \frac{a_n}{n^z}$ converges absolutely for some, but not all, values of z . Then there exists a constant x_1 (called the abscissa of absolute convergence) such that $\sum_{n=1}^{\infty} \frac{a_n}{n^z}$ converges absolutely if $\operatorname{Re} z > x_1$ and does not converge absolutely if $\operatorname{Re} z < x_1$.

Proof

$$\left| \frac{a_n}{n^z} \right| = \frac{|a_n|}{n^x}$$

So if $\sum_{n=1}^{\infty} \frac{a_n}{n^z}$ is absolutely convergent at z_0 , it is also absolutely convergent at all points z with $\operatorname{Re} z \geq \operatorname{Re} z_0$. The theorem follows with x_1 equal to the greatest lower bound of the real parts of all complex z for which $\sum_{n=1}^{\infty} \frac{a_n}{n^z}$ converges absolutely. \square

Note that if the coefficients a_n are all positive, the abscissas of convergence and absolute convergence must be identical. Otherwise there would be a real number x between them where the Dirichlet series is convergent but not absolutely convergent. But this is obviously impossible since the terms in the Dirichlet series, for real values of z , are all positive.

EXAMPLE

The function $\zeta(z)$ is defined by the Dirichlet series $\sum_{n=1}^{\infty} \frac{1}{n^z}$. This series converges absolutely for $\operatorname{Re} z > 1$, and diverges if $\operatorname{Re} z < 1$. \diamond

Since Dirichlet series converge uniformly within their half-plane of convergence, they can be differentiated term-by-term. So if $f(z) = \sum_{n=1}^{\infty} \frac{a_n}{n^z}$, then

$$f'(z) = \sum_{n=1}^{\infty} \frac{-a_n \log n}{n^z}.$$

For any value of z within the half-planes of convergence for two Dirichlet series, we have :

$$\sum_{n=1}^{\infty} \frac{a_n}{n^z} + \sum_{n=1}^{\infty} \frac{b_n}{n^z} = \sum_{n=1}^{\infty} \frac{a_n + b_n}{n^z}.$$

We can also multiply two Dirichlet series. Rewriting the product as another Dirichlet series involves a rearrangement of the terms, which is justified if the two series are absolutely convergent. Hence, within the half-planes of *absolute* convergence,

we have

$$\sum_{n=1}^{\infty} \frac{a_n}{n^z} \sum_{n=1}^{\infty} \frac{b_n}{n^z} = \sum_{n=1}^{\infty} \frac{c_n}{n^z}$$

with c_n defined as the “convolution” of a_n and b_n . That is,

$$c_n = \sum_{d|n} a_d b_{n/d}$$

where the sum is taken over all the positive divisors of n .

EXAMPLE

$$\zeta^2(z) = \sum_{n=1}^{\infty} \frac{1}{n^z} \sum_{n=1}^{\infty} \frac{1}{n^z} = \sum_{n=1}^{\infty} \frac{d(n)}{n^z}$$

where $d(n)$ equals the number of positive divisors of n .

Exercises

1. Prove

$$\prod_{k=2}^{\infty} \left(1 - \frac{1}{k^2}\right)$$

converges by finding an explicit formula for P_N .

2. As above, prove

$$\prod_{k=2}^{\infty} \left[1 + \frac{(-1)^k}{k}\right]$$

converges.

3.* Prove that $\prod_n \left(1 + \frac{i}{n}\right)$ diverges, but $\prod_n \left|1 + \frac{i}{n}\right|$ converges.

4. Show that if $\sum_{k=1}^{\infty} z_k$ converges and $\sum_{k=1}^{\infty} |z_k|^2$ converges, then $\prod_{k=1}^{\infty} (1 + z_k)$ converges.

5. Show that

$$\prod_{k=2}^{\infty} \left[1 + \frac{(-1)^k}{\sqrt{k}}\right]$$

diverges even though

$$\sum_{k=2}^{\infty} \frac{(-1)^k}{\sqrt{k}}$$

converges.

6. Prove that $(1+z)(1+z^2)(1+z^4)\dots = \prod_{k=0}^{\infty} (1+z^{2^k})$ converges uniformly on compacta to $1/(1-z)$ in $|z| < 1$. [Hint: Find P_N .]

7. Define an entire function g with single zeroes at and only at all the “squares” $\lambda_k = k^2$; $k = 1, 2, \dots$

8. Show that one solution to (7) is given by $\sin \pi \sqrt{z}/\pi \sqrt{z}$.

9. Prove that

$$\cos \pi z = \prod_{k=0}^{\infty} \left[1 - \frac{4z^2}{(2k+1)^2}\right].$$

10. a. Define a function f , analytic in $|z| < 1$ and such that

$$f(z) = 0 \quad \text{if and only if } z = 1 - \frac{1}{k}; \quad k = 1, 2, \dots$$

[Hint: Find an entire function g with zeroes at $\lambda_k = k, k = 1, 2, \dots$ and consider $f(z) = g(1/(1-z))$.]

- b. Generalize the above results.

11. Given $F(z) = \int_a^b \varphi(z, t) dt$. Derive the formula for $F'(z)$ by writing

$$F'(z) = \frac{1}{2\pi i} \int_C \frac{F(\zeta)}{(\zeta - z)^2} d\zeta = \frac{1}{2\pi i} \int_C \left(\int_a^b \frac{\varphi(\zeta, t)}{(\zeta - z)^2} dt \right) d\zeta$$

and switching the order of integration.

12. Complete Proposition 17.10 by splitting

$$\int_a^\beta \frac{h(u)y du}{(u-x)^2 + y^2} \quad \text{into} \quad \int_a^{x-\epsilon} + \int_{x-\epsilon}^{x+\epsilon} + \int_{x+\epsilon}^\beta.$$

13. Show that

$$f(z) = \int_0^1 \frac{dt}{1-zt}$$

is analytic outside $[1, \infty]$. Find the discontinuity of f as z “crosses” a point $x > 1$.

- 14.* a. Let $\phi(n)$ be the Euler totient function; i.e., the number of positive integers not exceeding n , which are relatively prime to n . Prove that

$$\sum_{n=1}^{\infty} \frac{\phi(n)}{n^z}$$

is absolutely convergent for $\text{Re } z > 2$.

- b. It can be shown that $\sum_{d|n} \phi(d) = n$, for all $n \geq 1$ [Apostol, p.26]. Show that $\zeta(z) \sum_{n=1}^{\infty} \frac{\phi(n)}{n^z} = \zeta(z-1)$, for $\text{Re } z > 2$.

Chapter 18

Analytic Continuation; The Gamma and Zeta Functions

Introduction

Suppose we are given a function f which is analytic in a region D . We will say that f can be continued analytically to a region D_1 that intersects D if there exists a function g , analytic in D_1 and such that $g = f$ throughout $D_1 \cap D$. By the Uniqueness Theorem (6.9) any such continuation of f is uniquely determined. (It is possible, however, to have two analytic continuations g_1 and g_2 of a function f to regions D_1 and D_2 respectively with $g_1 \neq g_2$ throughout $D_1 \cap D_2$. See Exercise 1.)

The Schwarz Reflection Principle (7.8) is an example of how, in some cases, an analytic function can be continued beyond its original domain of analyticity. In this chapter, we first examine the possibility of such “extensions” for functions given by power series. We then consider the classical Gamma and Zeta functions, defined originally by a definite integral and a Dirichlet series, respectively.

18.1 Power Series

As we have seen in Chapter 2, a power series, $\sum_{n=0}^{\infty} a_n z^n$, may converge at some or all or even none of the points on its circle of convergence. As the examples below indicate, the convergence or divergence of the power series at a point does not determine whether the function $f(z) = \sum_{n=0}^{\infty} a_n z^n$, can or cannot be continued beyond that point.

i.

$$f(z) = \frac{1}{1-z} = \sum_{n=0}^{\infty} z^n \quad \text{for } |z| < 1.$$

Although the power series diverges at every point on the unit circle, f is analytic throughout the punctured plane $z \neq 1$.

ii. $\sum_{n=1}^{\infty} (z^n/n^2)$ converges at all points on the unit circle; however, $g(z)$ cannot be continued analytically to a domain including $z = 1$ since

$$g''(z) = \sum_{n=0}^{\infty} \frac{(n+1)z^n}{n+2} \rightarrow \infty \quad \text{as } z \rightarrow 1^-.$$

18.1 Definition

Suppose that f is analytic in a disc D and that $z_0 \in \partial D$. Then f is said to be *regular* at z_0 if f can be continued analytically to a region D_1 with $z_0 \in D_1$. Otherwise, f is said to have a *singularity* at z_0 .

18.2 Theorem

If $\sum_{n=0}^{\infty} a_n z^n$ has a positive radius of convergence R , $f(z) = \sum_{n=0}^{\infty} a_n z^n$ has at least one singularity on the circle $|z| = R$.

Proof

If f were regular at every point on the circle of convergence, then for each z with $|z| = R$, there would exist some maximal ϵ_z such that f could be continued to a region containing $D(z; \epsilon_z)$. Clearly ϵ_z would depend continuously on z so that, since the circle $|z| = R$ is compact,

$$\min_{|z|=R} \epsilon_z = \epsilon > 0.$$

Hence, a function g would exist, analytic in $D(0; R + \epsilon)$ and such that $g = f$ in $D(0; R)$. But then g must have a power series representation $\sum_{n=0}^{\infty} b_n z^n$ convergent for $|z| < R + \epsilon$. Yet since $g(z) = f(z) = \sum_{n=0}^{\infty} a_n z^n$ for $|z| < R$, by the Uniqueness Theorem for Power Series (2.12), $a_n \equiv b_n$. Thus the radius of convergence would be R , and we have arrived at a contradiction. \square

In general, it is difficult to determine when a function has a singularity at a particular point on the circle of convergence of its power series. The following theorem is one of the few results we have in this direction.

18.3 Theorem

Suppose that $\sum_{n=0}^{\infty} a_n z^n$ has a radius of convergence $R < \infty$ and that $a_n \geq 0$ for all n . Then $f(z) = \sum_{n=0}^{\infty} a_n z^n$ has a singularity at $z = R$.

Proof

By Theorem 18.2, f has a singularity at some point $Re^{i\alpha}$. If we consider the power series for f about a point $\rho e^{i\alpha}$, with $0 < \rho < R$:

$$f(z) = \sum_{n=0}^{\infty} b_n (z - \rho e^{i\alpha})^n = \sum_{n=0}^{\infty} \frac{f^{(n)}(\rho e^{i\alpha})}{n!} (z - \rho e^{i\alpha})^n$$

we see that the radius of convergence of this series is $R - \rho$. (If it were larger, the power series would define an analytic extension of f beyond $Re^{i\alpha}$). Note, however,

that for any non-negative integer j ,

$$f^{(j)}(\rho e^{i\alpha}) = \sum_{n=j}^{\infty} n(n-1)\dots(n-j+1)a_n(\rho e^{i\alpha})^{n-j}$$

so that, since $a_n \geq 0$,

$$|f^{(j)}(\rho e^{i\alpha})| \leq f^{(j)}(\rho).$$

Hence the power series expansion of f about ρ ,

$$\sum_{n=0}^{\infty} \frac{f^{(n)}(\rho)}{n!} (z - \rho)^n,$$

must have radius of convergence $R - \rho$. On the other hand, if f were regular at $z = R$, the above power series would converge in a disc of radius greater than $R - \rho$; therefore, f is singular at $z = R$. \square

18.4 Definition

If $f(z) = \sum_{n=0}^{\infty} a_n z^n$ has a singularity at every point on its circle of convergence, then that circle is called a *natural boundary* of f .

EXAMPLE

$$\sum_{k=0}^{\infty} z^{2^k} = z + z^2 + z^4 + z^8 + \dots$$

has radius of convergence 1. Yet as $z \rightarrow z_0$, where z_0 is any 2^n th root of unity, all the terms of the power series past z^{2^n} approach 1, so that $f(z) \rightarrow \infty$. Hence f is singular at every 2^n th root of unity, $n \geq 1$. Since these are dense on the unit circle, that circle is a natural boundary for the power series. \diamond

Similarly, if we set $g(z) = \sum_{k=0}^{\infty} (z^{2^k}/2^k)$ it is clear that g has the unit circle as a natural boundary since $g'(z) = (1/z) \sum_{k=0}^{\infty} z^{2^k} \rightarrow \infty$ as z approaches any 2^n th root of unity. If we set $h(z) = \sum_{k=0}^{\infty} (z^{2^k}/2^{k^2})$ then, while h has radius of convergence 1, all of its derivatives are bounded throughout $|z| < 1$. Nevertheless, according to the following theorem, h too has a natural boundary on the unit circle.

18.5 Theorem

Suppose

$$f(z) = \sum_{k=0}^{\infty} c_k z^{n_k} \quad \text{with} \quad \underline{\lim}_{k \rightarrow \infty} \frac{n_{k+1}}{n_k} > 1.$$

Then the circle of convergence of the power series is a natural boundary for f .

Proof

Since the result is independent of c_k , we may assume without loss of generality that the radius of convergence is 1. Also, neglecting finitely many terms if necessary, we will assume that for some $\delta > 0$ and for all k , $n_{k+1}/n_k > 1 + \delta$. Finally, it suffices to show that f is singular at the point $z = 1$. For the same result, applied to the series $\sum_{k=0}^{\infty} c_k (ze^{-i\theta})^{n_k}$ shows that f is singular at any point $z = e^{i\theta}$.

Choose an integer $m > 0$ such that $(m + 1)/m < 1 + \delta$ and consider the power series $g(w)$ obtained by setting

$$z = \frac{w^m + w^{m+1}}{2}$$

and expanding the terms

$$\left(\frac{w^m + w^{m+1}}{2} \right)^{n_k}$$

in the power series of f :

$$\begin{aligned} g(w) = f\left(\frac{w^m + w^{m+1}}{2}\right) &= \frac{c_0 w^{mn_0}}{2^{n_0}} + \frac{c_0 n_0 w^{mn_0+1}}{2^{n_0}} + \cdots + \frac{c_0}{2^{n_0}} w^{mn_0+n_0} \\ &+ \frac{c_1}{2^{n_1}} w^{mn_1} + \frac{c_1 n_1}{2^{n_1}} w^{mn_1+1} + \cdots + \frac{c_1}{2^{n_1}} w^{mn_1+n_1} \\ &+ \cdots \end{aligned}$$

Note that in this expression no two terms involve the same power of w , since

$$mn_{k+1} > mn_k + n_k \text{ holds whenever } \frac{n_{k+1}}{n_k} > \frac{m+1}{m}.$$

If $|w| < 1$, then

$$\frac{|w|^m + |w|^{m+1}}{2} < 1,$$

and since $f(z)$ is absolutely convergent for $|z| < 1$,

$$\sum_{k=0}^{\infty} |c_k| \left(\frac{|w|^m + |w|^{m+1}}{2} \right)^{n_k} \text{ converges.}$$

Hence for $|w| < 1$, $g(w)$ is absolutely convergent. On the other hand, if we take w real and greater than 1, then

$$\frac{w^m + w^{m+1}}{2} > 1$$

so that

$$\sum_{k=0}^{\infty} c_k \left(\frac{w^m + w^{m+1}}{2} \right)^{n_k}$$

diverges. Note, though, that the j th partial sums s_j of the above series are exactly the $n_j(m+1)$ -st partial sums of the power series for g . Hence the series for $g(w)$ diverges and g , too, has radius of convergence 1. According to Theorem 18.2, g must have a singularity at some point w_0 with $|w_0| = 1$. If $w_0 \neq 1$, then

$$\left| \frac{w_0^m + w_0^{m+1}}{2} \right| < 1$$

and since f is analytic in $|z| < 1$, g is regular at w_0 . Thus g must have a singularity at $w_0 = 1$ and since

$$g(w) = f\left(\frac{w^m + w^{m+1}}{2}\right),$$

$f(z)$ must have a singularity at $z = 1$. □

The Method of Moments. Suppose we are given a power series $f(z) = \sum_{n=0}^{\infty} c_n z^n$ where the coefficients c_n are the “moments” of a given continuous function. For example, suppose that there exists a continuous function g on $[0, 1]$ such that

$$c_n = \int_0^1 g(t) \cdot t^n dt.$$

Then

$$\begin{aligned} f(z) &= \sum_{n=0}^{\infty} \left[\int_0^1 g(t) t^n dt \right] z^n \\ &= \sum_{n=0}^{\infty} \left[\int_0^1 g(t) (tz)^n dt \right], \end{aligned}$$

and, interchanging the order of summation and integration, we find that

$$\begin{aligned} f(z) &= \int_0^1 \left[\sum_{n=0}^{\infty} g(t) (tz)^n \right] dt \\ &= \int_0^1 \frac{g(t)}{1-tz} dt. \end{aligned}$$

(The interchange of summation and integration is easy to justify if $|z| < 1$.) Moreover, this integral form serves to define an analytic extension of the original power series.

EXAMPLES

i. Consider

$$f(z) = \sum_{n=0}^{\infty} \frac{z^n}{n+1}, \quad |z| < 1.$$

Since

$$\frac{1}{n+1} = \int_0^1 t^n dt,$$

$g(t) = 1$ and

$$f(z) = \int_0^1 \frac{dt}{1-tz} \quad \text{for } |z| < 1.$$

The integral above is analytic throughout the complex plane minus $[1, \infty)$. According to Proposition 17.10 this extension of f has a discontinuity at every point of the interval $[1, \infty)$.

ii. Since
$$\int_0^\infty e^{-nt^2} dt = \frac{1}{\sqrt{n}} \int_0^\infty \frac{e^{-u}}{2\sqrt{u}} du, \quad \frac{1}{\sqrt{n}} = c \int_0^\infty e^{-nt^2} dt,$$

where c is a positive constant. (We will show in the next section that the value of c is $2/\sqrt{\pi}$.) Hence

$$\begin{aligned} \sum_{n=1}^{\infty} \frac{z^n}{\sqrt{n}} &= c \sum_{n=1}^{\infty} \left[\int_0^\infty (ze^{-t^2})^n dt \right] \\ &= c \int_0^\infty \left[\sum_{n=1}^{\infty} (ze^{-t^2})^n \right] dt, \quad \text{for } |z| < 1 \\ &= c \int_0^\infty \frac{z}{e^{t^2} - z} dt. \end{aligned} \quad \diamond$$

Again, while the interchange of summation and integration is valid only in the original domain $|z| < 1$, the integral defines an analytic extension to the larger region: $\mathbb{C} \setminus [1, \infty)$. Again, by 17.10, the integral has a discontinuity at every point of $[1, \infty)$.

Many problems of this type can be solved by expressing the coefficients c_n in the form

$$c_n = \int_0^\infty e^{-nt} g(t) dt.$$

(In this case, c_n is obtained as the ‘‘Laplace Transform’’ of g at the integer n .) Some well-known formulae are listed below:

$$\begin{aligned} \frac{1}{n+a} &= \int_0^\infty e^{-nt} e^{-at} dt \\ \frac{a}{n^2+a^2} &= \int_0^\infty e^{-nt} \sin at dt \\ \frac{n}{n^2+a^2} &= \int_0^\infty e^{-nt} \cos at dt \\ \frac{1}{n^p} &= c_p \int_0^\infty e^{-nt} t^{p-1} dt, \quad p > 0. \end{aligned}$$

(The constants c_p are determined in terms of the Γ function which we will study in the next section. See Exercise 5.)

EXAMPLE

Let

$$f(z) = \sum_{n=0}^{\infty} \frac{n^2}{n^2 + 1} z^n.$$

Then

$$f(z) = z \frac{d}{dz} \left(\sum_{n=0}^{\infty} \frac{nz^n}{n^2 + 1} \right).$$

Using one of the above formulae

$$\begin{aligned} \sum_{n=0}^{\infty} \frac{n}{n^2 + 1} z^n &= \sum_{n=0}^{\infty} \left[\int_0^{\infty} (e^{-nt} \cos t) z^n dt \right] \\ &= \int_0^{\infty} \frac{e^t \cos t}{e^t - z} dt \quad \text{for } |z| < 1. \end{aligned}$$

Thus

$$f(z) = z \int_0^{\infty} \frac{e^t \cos t}{(e^t - z)^2} dt.$$

[Alternatively, we could write

$$f(z) = \sum_{n=0}^{\infty} \left(1 - \frac{1}{n^2 + 1} \right) z^n = \frac{1}{1 - z} - \sum_{n=0}^{\infty} \frac{1}{n^2 + 1} z^n, \quad \text{etc.} \dots] \quad \diamond$$

18.2 Analytic Continuation of Dirichlet Series

Dirichlet series, unlike power series, do not necessarily have a singularity on their boundary of convergence. For example, we will see in the next section that

$$\sum_{n=1}^{\infty} \frac{(-1)^n}{n^z}$$

can actually be continued to the full complex plane. However, if all the coefficients a_n are positive, we have the following analogue of Theorem 18.3.

18.6 Landau's Theorem

Suppose that $a_n \geq 0$ for all n , and that b is the real boundary point of the region of convergence of

$$f(z) = \sum_{n=1}^{\infty} \frac{a_n}{n^z}.$$

Then f has a singularity at b .

Proof

We will show that if f is regular at b ; that is, if it can be analytically extended to a region containing the point b , then the Dirichlet series will converge at some real number less than b , which contradicts the definition of b . Toward that end, choose a real number $a > b$, and consider the power series representation of f , centered at $z = a$. Since

$$f^{(k)}(z) = \sum_{n=1}^{\infty} \frac{a_n (-\log n)^k}{n^z},$$

the power series representation for f in a disc centered at $z = a$ is

$$f(z) = \sum_{k=0}^{\infty} c_k (z - a)^k \quad \text{with } c_k = \sum_{n=1}^{\infty} \frac{a_n (-\log n)^k}{n^a k!} \quad (1)$$

If f is regular at $z = b$, the radius of convergence of the series in (1) is greater than $a - b$ so that the series converges at a point of the form $b - \varepsilon$, with $\varepsilon > 0$. That is,

$$\sum_{k=0}^{\infty} \left(\sum_{n=1}^{\infty} \frac{a_n (\log n)^k}{n^a k!} \right) (a - b + \varepsilon)^k \quad (2)$$

converges. Since $a_n \geq 0$ for all n , all the terms in (2) are nonnegative. Hence it is an absolutely convergent series and, as such, its terms can be rearranged in any form. Suppose then that we first sum over k . Then

$$\sum_{k=0}^{\infty} \frac{(\log n)^k}{k!} (a - b + \varepsilon)^k = e^{(a-b+\varepsilon)\log n} = n^{a-b+\varepsilon}$$

and the convergent series in (2) becomes

$$\sum_{n=1}^{\infty} \frac{a_n n^{a-b+\varepsilon}}{n^a}$$

which is exactly the Dirichlet series with $z = b - \varepsilon$. □

18.7 Corollary

If a Dirichlet series has nonnegative coefficients and can be analytically continued to the entire complex plane, then it converges throughout the complex plane.

Proof

If the series did not converge for all z , according to Theorem 18.6, the function represented by the Dirichlet series would have a singularity at the real boundary point of its region of convergence. □

18.3 The Gamma and Zeta Functions

The Gamma Function. Consider the integral

$$I_n = \int_0^{\infty} e^{-t} t^n dt \quad n = 0, 1, 2, \dots$$

Integration by parts shows that

$$I_n = n \int_0^{\infty} e^{-t} t^{n-1} dt = n I_{n-1}.$$

Since $I_0 = 1$, the above recurrence relation implies

$$I_n = n!$$

for all positive integers n . Moreover, the above integral allows us to extend this “factorial” function to the complex plane. Note that

$$|t^z| = |e^{z \log t}| = e^{(\operatorname{Re} z) \log t} = t^{\operatorname{Re} z} \quad \text{for } t \geq 0$$

so that if we replace n by the complex variable z , the resulting function $f(z) = \int_0^{\infty} e^{-t} t^z dt$ is uniformly convergent for $\operatorname{Re} z > -1$. A translate of this function,

$$\Gamma(z) = \int_0^{\infty} e^{-t} t^{z-1} dt, \quad (1)$$

is the classical Gamma Function. Thus Γ is analytic in the right half-plane $\operatorname{Re} z > 0$ and $\Gamma(n) = (n-1)!$ for all positive integers n .

It is clear that Γ has a singularity at $z = 0$ since

$$\Gamma(\epsilon) = \int_0^{\infty} \frac{e^{-t}}{t^{1-\epsilon}} dt \rightarrow \infty \quad \text{as } \epsilon \rightarrow 0^+.$$

On the other hand, although (1) defines Γ only in the right half-plane, the function can be extended to the whole plane with the exception of isolated poles. We may carry out this extension in several ways.

I. Integration by parts shows that

$$\Gamma(z+1) = z\Gamma(z) \quad \text{for } \operatorname{Re} z > 0,$$

or equivalently,

$$\Gamma(z) = \frac{\Gamma(z+1)}{z} \quad \text{for } \operatorname{Re} z > 0. \quad (2)$$

Identity (2) allows us to define an extension of Γ to the half-plane $\operatorname{Re} z > -1, z \neq 0$. This extension is analytic for $-1 < \operatorname{Re} z < 0$ and is continuous along the nonzero y -axis since the “original” Γ is continuous on the line $\operatorname{Re} z = 1$. That is,

$$\lim_{z \rightarrow iy} \Gamma(z) = \lim_{z \rightarrow iy} \frac{\Gamma(z+1)}{z} = \frac{\Gamma(iy+1)}{iy} = \Gamma(iy), \quad y \neq 0.$$

Hence by Morera's Theorem the extended function is analytic throughout $\operatorname{Re} z > -1$, $z \neq 0$. Identity (2) also reveals the nature of the singularity at $z = 0$, since as $z \rightarrow 0$

$$\Gamma(z) = \frac{\Gamma(z+1)}{z} \sim \frac{\Gamma(1)}{z} = \frac{1}{z}.$$

Hence Γ has a simple pole with residue 1 at $z = 0$.

Continuing in the same manner, we can define

$$\begin{aligned} \Gamma(z) &= \frac{\Gamma(z+1)}{z} = \frac{\Gamma(z+2)}{z(z+1)} \quad \text{for } \operatorname{Re} z > -2, \\ \Gamma(z) &= \frac{\Gamma(z+3)}{z(z+1)(z+2)} \quad \text{for } \operatorname{Re} z > -3, \dots, \\ \Gamma(z) &= \frac{\Gamma(z+k+1)}{z(z+1)\cdots(z+k)} \quad \text{for } \operatorname{Re} z > -k-1. \end{aligned} \quad (3)$$

Note then that the only singularities are the isolated (simple) poles at the non-positive integers, and as $z \rightarrow -k$

$$\Gamma(z) \sim \frac{\Gamma(1)}{(-k)(-k+1)\cdots(-1)(z+k)} = \frac{(-1)^k}{k!(z+k)}.$$

Hence

$$\operatorname{Res}(\Gamma(z); -k) = \frac{(-1)^k}{k!}.$$

II. Set $\Gamma(z) = \Gamma_1(z) + \Gamma_2(z)$, where

$$\begin{aligned} \Gamma_1(z) &= \int_0^1 e^{-t} t^{z-1} dt \\ \Gamma_2(z) &= \int_1^\infty e^{-t} t^{z-1} dt, \quad \operatorname{Re} z > 0. \end{aligned}$$

Since $|t^{z-1}| = t^{\operatorname{Re} z - 1}$, Γ_2 is uniformly convergent for all z and represents an entire function. Thus, to extend Γ , we need only to extend Γ_1 . But for $\operatorname{Re} z > 0$

$$\begin{aligned} \Gamma_1(z) &= \int_0^1 \left(1 - t + \frac{t^2}{2!} - + \cdots \right) t^{z-1} dt \\ &= \int_0^1 t^{z-1} dt - \int_0^1 t^z dt + \int_0^1 \frac{t^{z+1}}{2!} - + \cdots \\ &= \frac{1}{z} - \frac{1}{(z+1)} + \frac{1}{2!(z+2)} - + \cdots \end{aligned}$$

The above series defines an analytic extension of Γ_1 to the whole plane except for isolated poles at $0, -1, -2, \dots$. Note again that

$$\operatorname{Res}(\Gamma; -k) = \operatorname{Res}(\Gamma_1; -k) = \frac{(-1)^k}{k!}.$$

III. Using the fact that $(1 - t/n)^n$ converges to e^{-t} as $n \rightarrow \infty$, one can show that

$$\begin{aligned}\Gamma(z) &= \lim_{n \rightarrow \infty} \int_0^n t^{z-1} \left(1 - \frac{t}{n}\right)^n dt \\ &= \lim_{n \rightarrow \infty} \frac{1}{n^n} \int_0^n t^{z-1} (n-t)^n dt, \quad \operatorname{Re} z > 0.\end{aligned}$$

(See Exercise 7.)

Integrating by parts, we have

$$\begin{aligned}\Gamma(z) &= \lim_{n \rightarrow \infty} \frac{1}{n^n} \cdot \frac{n}{z} \int_0^n t^z (n-t)^{n-1} dt \\ &= \lim_{n \rightarrow \infty} \frac{1}{n^n} \frac{n(n-1) \cdots 1}{z(z+1) \cdots (z+n-1)} \int_0^n t^{z+n-1} dt \\ &= \lim_{n \rightarrow \infty} \frac{n^z}{z} \left(\frac{1}{z+1}\right) \left(\frac{2}{z+2}\right) \cdots \left(\frac{n}{z+n}\right).\end{aligned}$$

Thus,

$$\begin{aligned}\frac{1}{\Gamma(z)} &= \lim_{n \rightarrow \infty} zn^{-z} (1+z) \left(1 + \frac{z}{2}\right) \cdots \left(1 + \frac{z}{n}\right) \\ &= \lim_{n \rightarrow \infty} zn^{-z} \prod_{k=1}^n \left(1 + \frac{z}{k}\right).\end{aligned}$$

To examine the above limit, we insert “convergence factors” $e^{-z/k}$ and obtain

$$\begin{aligned}\frac{1}{\Gamma(z)} &= \lim_{n \rightarrow \infty} zn^{-z} e^{z(1+1/2+\cdots+1/n)} \prod_{k=1}^n \left(1 + \frac{z}{k}\right) e^{-z/k} \\ &= \lim_{n \rightarrow \infty} e^{z(1+1/2+\cdots+1/n - \log n)} \left[z \prod_{k=1}^n \left(1 + \frac{z}{k}\right) e^{-z/k} \right].\end{aligned}$$

By the lemma below, $1 + \frac{1}{2} + \cdots + 1/n - \log n$ approaches a positive limit γ (known as the Euler constant) so that

$$\frac{1}{\Gamma(z)} = ze^{\gamma z} \prod_{k=1}^{\infty} \left(1 + \frac{z}{k}\right) e^{-z/k}.$$

Using the above identity to define an extension of Γ to the left half-plane, we obtain

$$\frac{1}{\Gamma(z)\Gamma(-z)} = -z^2 \prod_{k=1}^{\infty} \left(1 - \frac{z^2}{k^2}\right) = -z \frac{\sin \pi z}{\pi}.$$

Thus

$$\Gamma(z)\Gamma(-z) = \frac{-\pi}{z \sin \pi z},$$

and since $\Gamma(1 - z) = -z\Gamma(-z)$,

$$\Gamma(z)\Gamma(1 - z) = \frac{\pi}{\sin \pi z}. \quad (4)$$

Two immediate consequences of identity (4) are

- i. Γ is zero-free,
- ii. $\Gamma(\frac{1}{2}) = \sqrt{\pi}$. Applying the identity $\Gamma(z + 1) = z\Gamma(z)$, we have also $\Gamma(3/2) = \frac{1}{2}\sqrt{\pi}$, $\Gamma(5/2) = 3\sqrt{\pi}/4$, etc.

18.8 Lemma

If $s_n = 1 + \frac{1}{2} + \cdots + 1/n - \log n$, then $\lim_{n \rightarrow \infty} s_n$ exists. This limit is called the Euler constant, γ .

Proof

$t_n = 1 + \frac{1}{2} + \cdots + 1/(n-1) - \log n$ increases with n . Geometrically this is obvious since t_n represents the area of the $n-1$ regions between the upper Riemann sum and the exact value for $\int_1^n (1/x) dx$. We can write

$$t_n = \sum_{k=1}^{n-1} \left[\frac{1}{k} - \log \left(\frac{k+1}{k} \right) \right]$$

and

$$\lim_{n \rightarrow \infty} t_n = \sum_{k=1}^{\infty} \left[\frac{1}{k} - \log \left(1 + \frac{1}{k} \right) \right].$$

The series above converges to a positive constant since

$$0 < \frac{1}{k} - \log \left(1 + \frac{1}{k} \right) = \frac{1}{2k^2} - \frac{1}{3k^3} + \frac{1}{4k^4} - + \cdots \leq \frac{1}{2k^2}.$$

This proves the lemma, because $\lim_{n \rightarrow \infty} s_n = \lim_{n \rightarrow \infty} t_n$. □

The Zeta Function. Recall that the Zeta Function $\zeta(z)$ is defined by the Dirichlet series

$$\zeta(z) = 1 + \frac{1}{2^z} + \frac{1}{3^z} + \cdots, \quad \text{Re } z > 1.$$

This function is of special interest in number theory because it provides a link between the prime numbers and analytic function theory. To see this connection, note that

$$\frac{1}{2^z} \zeta(z) = \frac{1}{2^z} + \frac{1}{4^z} + \frac{1}{6^z} + \cdots$$

so that

$$\left(1 - \frac{1}{2^z} \right) \zeta(z) = 1 + \frac{1}{3^z} + \frac{1}{5^z} + \cdots.$$

Similarly,

$$\left(1 - \frac{1}{2^z}\right) \left(1 - \frac{1}{3^z}\right) \zeta(z) = 1 + \frac{1}{5^z} + \frac{1}{7^z} + \frac{1}{11^z} + \cdots,$$

and because of the unique prime factorization of the integers, we can continue indefinitely to obtain (in the limit)

$$\prod_{p \text{ prime}} \left(1 - \frac{1}{p^z}\right) \zeta(z) = 1.$$

That is

$$\zeta(z) = 1 \bigg/ \prod_{p \text{ prime}} \left(1 - \frac{1}{p^z}\right), \quad \operatorname{Re} z > 1. \quad (5)$$

To best exploit identity (5), we need to extend ζ beyond the domain $\operatorname{Re} z > 1$. Note that ζ does have a singularity at $z = 1$ since $\zeta(1 + \epsilon) \rightarrow \infty$ as $\epsilon \rightarrow 0^+$. We shall see below that this is the only singularity of the ζ function.

We extend ζ by the method of moments. Note that

$$\int_0^\infty e^{-nt} t^{z-1} dt = \frac{1}{n^z} \int_0^\infty e^{-t} t^{z-1} dt = \frac{\Gamma(z)}{n^z}$$

so that

$$\begin{aligned} \Gamma(z) \sum_{n=1}^\infty \frac{1}{n^z} &= \int_0^\infty t^{z-1} \left(\sum_{n=1}^\infty e^{-nt} \right) dt \\ &= \int_0^\infty \frac{t^{z-1}}{e^t - 1} dt. \end{aligned}$$

That is,

$$\zeta(z) = \frac{1}{\Gamma(z)} \int_0^\infty \frac{t^{z-1}}{e^t - 1} dt$$

or

$$\zeta(z) = \frac{1}{\Gamma(z)} \left[\int_0^1 \frac{t^{z-1}}{e^t - 1} dt + \int_1^\infty \frac{t^{z-1}}{e^t - 1} dt \right]. \quad (6)$$

Recall that $1/\Gamma(z)$ (with the appropriate limiting value of zero at the poles of Γ) is entire, as is $\int_1^\infty (t^{z-1}/(e^t - 1)) dt$. Furthermore, the Laurent Expansion for $1/(e^t - 1)$ around $t = 0$,

$$\frac{1}{e^t - 1} = \frac{1}{t} + A_0 + A_1 t + A_2 t^2 + \cdots,$$

converges absolutely for $t = 1$ so that

$$\begin{aligned} \int_0^1 \frac{t^{z-1}}{e^t - 1} dt &= \int_0^1 (t^{z-2} + A_0 t^{z-1} + A_1 t^z + \dots) dt \\ &= \frac{1}{z-1} + \frac{A_0}{z} + \frac{A_1}{z+1} + \dots \end{aligned} \quad (7)$$

provides an analytic extension of $\int_0^1 (t^{z-1}/(e^t - 1)) dt$ except for isolated poles. According to (6), then

$$\zeta(z) = \frac{1}{\Gamma(z)} \left[\left(\frac{1}{z-1} + \frac{A_0}{z} + \frac{A_1}{z+1} \dots \right) + g(z) \right] \quad (8)$$

where $g(z)$ is entire. Note that while the bracketed expression above has a simple pole at $z = 1$ as well as at every non-positive integer, all these poles are cancelled by the zeros of $1/\Gamma(z)$ except $z = 1$. Hence ζ has a single (simple) pole at $z = 1$ with residue 1.

For future reference, then, we record

18.9 Theorem

The only singularity of the Zeta function $\zeta(z)$ is a simple pole with residue 1 at $z = 1$.

According to (5), ζ is zero-free for $\operatorname{Re} z > 1$. The celebrated Riemann hypothesis asserts that all the complex zeroes of the Zeta function lie on the line $\operatorname{Re} z = \frac{1}{2}$. While this hypothesis has neither been proved nor disproved, the following theorem offers an important extension of the zero-free region of ζ .

18.10 Theorem

ζ is zero-free throughout $\operatorname{Re} z \geq 1$.

Proof

A key element in the proof is the observation that if $\zeta(1 + ia) = 0$, then the function $f(z) = \zeta(z)\zeta(z + ia)$ is entire. At $z = 1$, the pole of $\zeta(z)$ is cancelled by the zero of $\zeta(z + ia)$. Also, since $\zeta(z)$ is real-valued for real z , according to the Schwarz Reflection Principle, $\zeta(\bar{z}) = \overline{\zeta(z)}$. Hence $\zeta(1 - ia) = 0$, and the pole of $\zeta(z + ia)$ at $z = 1 - ia$ is cancelled by the zero of $\zeta(z)$ at that point. Note that $f(z - ia) = \zeta(z - ia)\zeta(z)$ will also be entire as will the product $g(z) = f(z)f(z - ia) = \zeta^2(z)\zeta(z + ia)\zeta(z - ia)$. The desired contradiction will be based, in part, on the fact that the Dirichlet series for $g(z)$ has all nonnegative coefficients. To see that, we first consider $\log(g(z))$ which, according to Euler's formula for $\zeta(z)$, is given by

$$\begin{aligned} \log(g(z)) &= \sum_p [-2 \log(1 - p^{-z}) - \log(1 - p^{-z+ia}) - \log(1 - p^{-z-ia})] \\ &= \sum_{p,n} \frac{1}{np^{nz}} (2 + p^{-ina} + p^{ina}) \end{aligned}$$

The sum is taken over all primes p and all positive integers n . Since $2 + p^{-ina} + p^{ina} = 2 + 2 \cos(na \log p) \geq 0$, all of the coefficients in the above Dirichlet series for $\log(g(z))$ are nonnegative. But if a Dirichlet series $S(z) = \sum a_n n^{-z}$ has all nonnegative coefficients, so does

$$e^{S(z)} = \prod_n \sum_k \frac{a_n^k}{n^{kz} k!}$$

Hence $g(z)$ represents an entire function whose Dirichlet series has all nonnegative coefficients. According to Corollary 17.12, then, its Dirichlet series must converge for all z ! But this is clearly impossible. Since all of the coefficients of

$$g(z) = \left(\sum_n n^{-z} \right)^2 \sum_n n^{-z-ia} \sum_n n^{-z+ia}$$

are nonnegative, the sum is clearly positive for all real z . Moreover, the sum must be larger than the sum over any subset of the positive integers. So if we consider nonnegative real values of z and limit ourselves to the subseries corresponding to integers n of the form 2^k , we have

$$|g(z)| > \frac{1}{(1-2^{-z})^2} \cdot \frac{1}{1-2^{-z-ia}} \cdot \frac{1}{1-2^{-z+ia}}$$

Finally, since z is nonnegative, $|(1-2^{-z-ia})(1-2^{-z+ia})| \leq 4$, and

$$|g(z)| > \frac{1}{4(1-2^{-z})^2}$$

Letting $z \rightarrow 0$ through positive real values, then, shows that the Dirichlet series for g diverges at 0. \square

Exercises

- Let $f(z) = \log z$, $\operatorname{Re} z > 0$, $\operatorname{Im} z > 0$. Let g_1 be the continuation of f to the plane minus the negative axis (and 0) and let g_2 be the continuation of f to the plane minus the negative imaginary axis (and 0). Show that $g_1 \neq g_2$ throughout the third quadrant.
- * a. Suppose $f(z) = \sum a_n z^n$ has radius of convergence 1 and assume that an analytic continuation of f has a pole at $z = 1$. Show that $\sum a_n z^n$ diverges at every point on the unit circle. (Hint: Show that if $\{a_n\} \rightarrow 0$, then $(1-z)f(z) \rightarrow 0$ as $z \rightarrow 1$ from below, along the x -axis.)
 b. Generalize the result; i.e. show that if $f(z) = \sum a_n z^n$ has a positive radius of convergence and an analytic continuation of $\sum a_n z^n$ has a pole at any point on its circle of convergence, then $\sum a_n z^n$ diverges at all points on the circle of convergence.
- Prove: If $\sum_{n=0}^{\infty} (-1)^n a_n z^n$, $a_n \geq 0$ has a finite radius of convergence, then it has a singularity on the negative axis.

4. Define an analytic continuation of

$$\text{a. } \sum_{n=1}^{\infty} \frac{z^n}{\sqrt[n]{n}}, \quad \text{b. } \sum_{n=0}^{\infty} \frac{z^n}{n^2 + 1}.$$

5. Show that

$$\int_0^{\infty} e^{-nt} t^{p-1} dt = \frac{\Gamma(p)}{n^p} \quad \text{for } p > 0.$$

6. Use the Gamma Function to show

$$\int_0^{\infty} e^{-t^2} dt = \frac{\sqrt{\pi}}{2}.$$

7. Prove

$$\Gamma(z) = \lim_{n \rightarrow \infty} \int_0^n t^{z-1} \left(1 - \frac{t}{n}\right)^n dt, \quad \operatorname{Re} z > 0.$$

[Hint: First show, for $t \leq n$,

$$0 \leq e^{-t/n} - \left(1 - \frac{t}{n}\right) \leq \frac{t^2}{2n^2}$$

and then use the identity

$$a^n - b^n \leq na^{n-1}(a - b) \quad \text{for } a > b$$

to show

$$\left| e^{-t} - \left(1 - \frac{t}{n}\right) \right| \leq e^{-t} \left(\frac{et^2}{2n} \right).]$$

8.* Use the product formula for $1/\Gamma(z)$ to prove that $\Gamma'(1) = -\gamma$.

9. Show that

$$1 - \frac{1}{2^z} + \frac{1}{3^z} - \frac{1}{4^z} + \dots$$

can be continued analytically to the full plane. That is, show that it represents an entire function.

10. Use identity (5) to prove $\sum_p \text{prime} (1/p)$ diverges.

Chapter 19

Applications to Other Areas of Mathematics

Introduction

We have already seen, especially in Chapter 11, how the methods of complex analysis can be applied to the solution of problems from other areas of mathematics. In this chapter we will get some insight into the fantastic breadth of such applications. For that reason, the topics chosen are rather disparate. Section 19.1 involves calculating the total variation of a real function, and illustrates how the methods of Chapter 11 can be applied to yet another nontypical problem. Section 19.2 offers a proof of the classic Fourier Uniqueness Theorem using two preliminary results from real analysis and a surprising application of Liouville's theorem. In Section 19.3 we see how the use of a generating function allows complex analytic results to be applied to an infinite system of (real) equations. Generating functions are also the key to the four different problems in number theory that comprise section 19.4. Finally, in section 19.5, we offer a well-trimmed analytic proof of the prime number theorem based on properties of the Zeta function and another Dirichlet series.

19.1 A Variation Problem

PROBLEM

Calculate the total variation of $\sin^2 x/x^2$ on $(-\infty, \infty)$.

Note: $(\sin^2 x/x^2)$ is nonnegative and clearly has one local maximum between each pair of adjacent zeros. Hence the total variation is simply twice the sum of its maximum values. This problem is related to the type of sums encountered in 11.2. The novelty here lies in the fact that while we will not explicitly determine the maximum points x_k ; $k = 1, 2, \dots$, we will be able to find the desired sum:

$$\sum_{k=1}^{\infty} \frac{\sin^2 x_k}{x_k^2}.$$

SOLUTION

The maximum points of $\sin^2 x/x^2$ are given by those zeros of its derivative that are not zeroes of $\sin x/x$, and these are the (real) solutions of $x \cos x - \sin x = 0$, or simply $\tan x = x$. We leave it as an exercise to verify that $\tan z = z$ has no nonreal solutions. Thus we need only sum the values of $\sin^2 x/x^2$ at the zeroes of $\tan z - z$.

Except for $z = 0$, all the zeroes of $\tan z - z$ are simple. We recall that f'/f has residue 1 at every simple zero of f , thus we see that

$$\sum \frac{\sin^2 x_k}{x_k^2} = \frac{1}{2\pi i} \int_{C_N} f_1(z) dz - \text{Res}(f_1; 0)$$

where

$$f_1(z) = \frac{\sin^2 z \tan^2 z}{z^2(\tan z - z)}$$

and where the sum is taken over all the nonzero maximum points x_k that lie inside C_N . However, we must find a sequence of suitable contours C_N which contain all the points x_k (in the limit) and are such that $\lim_{N \rightarrow \infty} \int_{C_N} f_1(z) dz$ can be determined.

If we take C_N to be the square of side $2\pi N$ centered at $z = 0$, it follows that $|\tan z| < 2$ throughout C_N . [See 11.2 and use the fact that $\tan z = \cot(\pi/2 - z)$]. However, there are several difficulties. Not only is $\sin z$ unbounded throughout C_N , but $f_1(z)$ introduces an infinity of residues at the poles of $\tan z$. To overcome these difficulties we replace

$$\frac{\sin^2 z \tan^2 z}{z^2}$$

by another analytic function with the same values at the zeroes of $\tan z - z$. Thus we substitute z^2 for $\tan^2 z$ and since

$$\sin^2 z = \frac{\tan^2 z}{1 + \tan^2 z},$$

we consider

$$f_2(z) = \frac{z^2}{(1 + z^2)(\tan z - z)}.$$

Again, however, there is a difficulty. While $f_2(z) \rightarrow 0$ along C_N (as $N \rightarrow \infty$), it is *not* true that $\int_{C_N} f_2(z) dz \rightarrow 0$ since for large z , $f_2(z) \sim -1/z$. (See Exercise 2.) Hence we make one more adjustment and consider finally

$$f_3(z) = \frac{z \tan z}{(1 + z^2)(\tan z - z)}.$$

Note that f_3 is *analytic* at the poles of $\tan z$ and that $|f_3(z)| \leq A/|z|^2$ throughout C_N . Thus it follows that

$$\int_{C_N} f_3(z) dz \rightarrow 0 \quad \text{as } N \rightarrow \infty, \quad (1)$$

while, on the other hand,

$$\begin{aligned} \int_{C_N} f_3(z) dz &\rightarrow 2\pi i \sum \operatorname{Res}(f_3(z)) \\ &= 2\pi i \left[\sum_{\substack{k=1 \\ x_k \neq 0}}^{\infty} \frac{\sin^2 x_k}{x_k^2} + \operatorname{Res}(f_3; 0) + \operatorname{Res}(f_3; i) + \operatorname{Res}(f_3; -i) \right]. \end{aligned} \quad (2)$$

A direct calculation shows that $\operatorname{Res}(f_3; i) = \operatorname{Res}(f_3; -i) = (1 - e^2)/4$. Expanding

$$f_3(z) = \frac{z \sin z}{(1 + z^2)(\sin z - z \cos z)}$$

around $z = 0$, we see that $\operatorname{Res}(f_3; 0) = 3$. Since $\sin^2 x/x^2 = 1$ at $x = 0$, a comparison of (1) and (2) shows that

$$\operatorname{Var}\left(\frac{\sin^2 x}{x^2}\right) = 2 \sum_{k=1}^{\infty} \frac{\sin^2 x_k}{x_k^2} = e^2 - 5. \quad \diamond$$

19.2 The Fourier Uniqueness Theorem

Suppose f is Lebesgue-integrable on $(-\infty, \infty)$. Then, by definition, $\int_{-\infty}^{\infty} |f(t)| dt < \infty$, and for any real x , $\int_{-\infty}^{\infty} f(t)e^{ixt} dt$ exists. The function $\hat{f}(x)$ defined as $\hat{f}(x) = \int_{-\infty}^{\infty} f(t)e^{ixt} dt$ is called the *Fourier transform* of f . The question we consider is whether f is uniquely determined by \hat{f} . That is, does $\hat{f} \equiv 0$ imply $f \equiv 0$ in the L^1 sense: that is, almost everywhere? The answer is yes and is usually found by appealing to an inversion formula which allows one to recover f from \hat{f} . The analytic proof below is somewhat more direct. We do, however, require two elementary results from the Lebesgue theory.

19.1 Lemma

If $g_n(x)$ is a sequence of measurable functions such that $|g_n(x)| \leq G(x)$, where $G(x)$ is integrable, for all values of x and n , and if

$$\lim_{n \rightarrow \infty} g_n(x) = g(x)$$

for all x , then

$$\lim_{n \rightarrow \infty} \int_{-\infty}^{\infty} g_n(x) dx = \int_{-\infty}^{\infty} g(x) dx.$$

Proof

See [Titchmarsh, p. 345]. □

19.2 Lemma

If f is integrable and if $\int_{-\infty}^a f(t)dt = 0$ for all real a , then $f = 0$ almost everywhere.

Proof

[Titchmarsh, p. 360]. □

19.3 Fourier Uniqueness Theorem

If f is integrable and if

$$\hat{f}(x) = \int_{-\infty}^{\infty} f(t)e^{ixt} dt \equiv 0,$$

then $f = 0$ almost everywhere.

Proof

By hypothesis, for any real a ,

$$\int_{-\infty}^a f(t)e^{ix(t-a)} dt = - \int_a^{\infty} f(t)e^{ix(t-a)} dt. \quad (3)$$

If we set

$$L(z) = \int_{-\infty}^a f(t)e^{iz(t-a)} dt, \quad R(z) = - \int_a^{\infty} f(t)e^{iz(t-a)} dt,$$

then $L(z)$ is defined for $\text{Im } z \leq 0$ while $R(z)$ is defined for $\text{Im } z \geq 0$. Moreover each is analytic in the interior of its domain, continuous to the boundary (according to Lemma 19.1), and bounded by $\int_{-\infty}^{\infty} |f(t)|dt$. Since, by (3), they agree on the boundary, we can invoke Theorem 7.7 to prove that the “combined” function

$$F(z) = \begin{cases} L(z) & \text{Im } z \leq 0 \\ R(z) & \text{Im } z > 0 \end{cases}$$

is entire. By Liouville’s Theorem (5.10), the boundedness of F implies that F is constant. Finally, setting $z = Ni$ we have $F(Ni) = R(Ni) = \int_a^{\infty} -f(t)e^{-N(t-a)} dt$ which approaches 0 as $N \rightarrow \infty$, by Lemma 19.1. Hence $F(z) \equiv 0$. In particular, setting $z = 0$ yields

$$F(0) = \int_{-\infty}^a f(t)dt = 0.$$

Since this holds for all real a , according to Lemma 19.2, $f = 0$ almost everywhere. □

19.3 An Infinite System of Equations

Consider the infinite system of equations

$$\begin{aligned} a_1 + b_1 &= 2 \\ a_2 + 2a_1b_1 + b_2 &= 4 \\ a_3 + 3a_2b_1 + 3a_1b_2 + b_3 &= 8 \\ &\dots \\ a_n + \binom{n}{1} a_{n-1}b + \binom{n}{2} a_{n-2}b_2 + \dots + b_n &= 2^n. \\ &\dots \end{aligned}$$

PROBLEM

Assuming $a_1 = b_1 = 1$ and $a_k, b_k \geq 0$ for all k , does there exist a solution to the system above *other than* $a_n \equiv 1, b_n \equiv 1$? \square

Note that if we do not insist $a_k, b_k \geq 0$, there are an infinite number of solutions, since each equation introduces two new unknowns. Somewhat surprisingly, then, the answer to the given problem is *no*. (Somehow, any scheme to solve the equations successively is doomed to eventually introduce negative values for a_k or b_k .)

SOLUTION

Assume the sequences $\{a_n\}$ and $\{b_n\}$ yield a solution to the above system. To study these sequences, we consider their “exponential generating functions”. That is, we define

$$f(z) = \sum_{n=0}^{\infty} \frac{a_n z^n}{n!}, \quad g(z) = \sum_{n=0}^{\infty} \frac{b_n z^n}{n!}$$

with $a_0 = b_0 = 1$. Since $a_k, b_k \geq 0$, for all k , it follows that $a_k, b_k \leq 2^k$, so that both $f(z)$ and $g(z)$ are entire functions.

Note that

$$\begin{aligned} f(z)g(z) &= \sum_{n=0}^{\infty} C_n z^n \quad \text{where } C_n = \sum_{j=0}^n \frac{a_{n-j} b_j}{(n-j)! j!} \\ &= \sum_{j=0}^n \binom{n}{j} \frac{a_{n-j} b_j}{n!}, \end{aligned}$$

so that according to the hypothesis

$$f(z)g(z) = \sum_{n=0}^{\infty} \frac{2^n z^n}{n!} = e^{2z}.$$

Thus f and g are entire functions with no zeros and both are of linear order. According to Theorem 16.13, then,

$$f(z) = e^{\alpha z + \beta} \text{ and } g(z) = e^{\gamma z + \delta}.$$

Since

$$f(0) = g(0) = a_0 = b_0 = 1,$$

$f(z) = e^{\alpha z}$ and $g(z) = e^{\gamma z}$. On expanding

$$f(z) = e^{\alpha z} = 1 + \alpha z + \frac{\alpha^2 z^2}{2!} + \cdots = 1 + z + \frac{a_2 z^2}{2!} + \cdots$$

$$g(z) = e^{\gamma z} = 1 + \gamma z + \frac{\gamma^2 z^2}{2!} + \cdots = 1 + z + \frac{b_2 z^2}{2!} + \cdots$$

it follows that $\alpha = \gamma = 1$ and hence $a_n \equiv b_n \equiv 1$. ◇

19.4 Applications to Number Theory

Like the example in Section 19.3, all of the problems in this section involve sequences of real numbers, and in each case we will consider an appropriate generating function. Note, therefore, that the ordinary generating function of a sequence $\{c_n\}$ is the power series $\sum c_n z^n$.

I A Partition Problem

PROBLEM

Can the positive integers $\{1, 2, 3, \dots\}$ be partitioned into a finite number of sets S_1, S_2, \dots, S_k , each of which is an arithmetic progression - that is,

$$S_1 = \{a_1, a_1 + d_1, a_1 + 2d_1, \dots\}$$

$$S_2 = \{a_2, a_2 + d_2, a_2 + 2d_2, \dots\}$$

...

$$S_k = \{a_k, a_k + d_k, a_k + 2d_k, \dots\}$$

and such that there are no equal common differences (i.e. $d_i \neq d_j$ for $i \neq j$)?

Note that if we allowed equal common differences, the answer would be obviously yes. For example, we could take $S_1 = \{\text{odd integers}\}$ and $S_2 = \{\text{even integers}\}$. With the given hypothesis, as we shall see, the answer is no.

SOLUTION

For any set $S = \{a, a + d, a + 2d, \dots\}$, consider the sequence $\{c_n\}$, where $c_n = 1$ if $n \in S$, and $c_n = 0$ otherwise. Then the generating function for the sequence $\{c_n\}$ is

the geometric series

$$\sum_{n \in S} z^n = \frac{z^a}{1 - z^d}$$

Assume that S_1, S_2, \dots, S_k (as above) partition the set of positive integers. Taking the various generating functions, we would then have

$$\sum_{n=1}^{\infty} z^n = \sum_{n \in S_1} z^n + \sum_{n \in S_2} z^n + \cdots + \sum_{n \in S_k} z^n$$

or

$$\frac{z}{1 - z} = \frac{z^{a_1}}{1 - z^{d_1}} + \frac{z^{a_2}}{1 - z^{d_2}} + \cdots + \frac{z^{a_k}}{1 - z^{d_k}}. \quad (4)$$

Since $d_i \neq d_j$, we may assume $d_1 > d_j$ for $j \neq 1$. It follows that as $z \rightarrow e^{2\pi i/d_1}$ the first term on the right side of (4) will approach infinity while all the others approach a finite limit. This clearly contradicts (4) and hence no partition of the desired type is possible. \square

II Making Change

Suppose the coins in a certain country had the values 3 cents, 8 cents, and 15 cents. How many ways could we offer change for \$1.00 using those coins? A direct check would show that the answer is 15, but would not really suggest an approach to the more general question: Can we find a formula for $C(n)$, the number of ways that an arbitrary nonnegative integer n can be expressed as a (nonnegative) integral combination of 3's, 8's and 15's? Note that, by the familiar rule for the product of power series, the generating function for the sequence $\{C(n)\}$ is

$$\sum_{n=0}^{\infty} C(n)z^n = (1 + z^3 + z^6 + \cdots)(1 + z^8 + z^{16} + \cdots)(1 + z^{15} + z^{30} + \cdots)$$

or

$$\sum_{n=0}^{\infty} C(n)z^n = \frac{1}{1 - z^3} \cdot \frac{1}{1 - z^8} \cdot \frac{1}{1 - z^{15}} \quad (5)$$

So our search for $C(n)$ leads to a search for the coefficient of z^n in the product on the right side of (5). To that end, we would like to find the partial fraction decomposition for the function

$$R(z) = \frac{1}{1 - z^3} \cdot \frac{1}{1 - z^8} \cdot \frac{1}{1 - z^{15}}$$

Note that since R is a proper rational function; i.e., $R(z) \rightarrow 0$ as $z \rightarrow \infty$, the partial fraction decomposition is simply the sum of the principal parts of the Laurent expansions about each of the singularities (see Theorem 9.13). Let

$$\alpha = e^{2\pi i/3}, \beta = e^{2\pi i/8}, \gamma = e^{2\pi i/15}$$

and express $R(z)$ as

$$R(z) = - \prod_{n=1}^3 \frac{1}{z - \alpha^n} \prod_{n=1}^8 \frac{1}{z - \beta^n} \prod_{n=1}^{15} \frac{1}{z - \gamma^n}.$$

R has a pole of order three at $z = 1 (= \alpha^3 = \beta^8 = \gamma^{15})$, double poles at $\alpha (= \gamma^5)$ and at $\alpha^2 (= \gamma^{10})$ and simple poles at its other 19 singularities. Hence R has a partial fraction decomposition of the form

$$R(z) = \sum_{k=1}^3 \frac{a_k}{(z-1)^k} + \sum_{k=1}^2 \frac{b_k}{(z-\alpha)^k} + \sum_{k=1}^2 \frac{c_k}{(z-\alpha^2)^k} + \sum_{j=1}^{19} \frac{d_j}{(z-z_j)} \quad (6)$$

where the numbers z_j represent the 19 simple poles of $R(z)$. Note that if we can find all the coefficients a_k, b_k, c_k and d_j , we will be able to find the desired coefficient of z^n in $R(z)$. This is because repeated differentiation of the familiar identity

$$\frac{1}{z-\omega} = \frac{-1}{\omega(1-z/\omega)} = \frac{-1}{\omega} \left(1 + \frac{z}{\omega} + \frac{z^2}{\omega^2} + \cdots \right)$$

shows that

$$\text{the coefficient of } z^n \text{ in } \left(\frac{1}{z-\omega} \right)^k \text{ is } \frac{-1}{\omega^{n+1}}, \frac{n+1}{\omega^{n+2}}, \text{ and } -\frac{(n+2)(n+1)}{2\omega^{n+3}}$$

for $k = 1, 2,$ and $3,$ respectively. (7)

Hence we can apply the techniques discussed in Chapter 10 to find all of the coefficients a_k, b_k, c_k and d_j , and we can then complete the job by applying formula (7) to each of the terms of (6), taking $\omega = 1$ and $k = 1, 2,$ and 3 ; $\omega = \alpha$ and $\omega = \alpha^2$ with $k = 1$ and 2 ; and $\omega = z_j$ for each value of j (with $k = 1$).

For obvious reasons, we will choose to skip the remaining details. Instead, we will leave the reader the challenge of completing a similar exercise with more "reasonable" numbers. However, we can easily answer a related question: That is, putting aside the problem of finding the exact formula for $C(n)$, can we find an asymptotic formula? In other words, can we identify a familiar function $f(n)$ with the property that $C(n)/f(n) \rightarrow 1$ as $n \rightarrow \infty$? To find $f(n)$, we need only look at formulas (6) and (7) to see that the "largest" contribution to $C(n)$, the only one with order of magnitude n^2 , corresponds to $\omega = 1$ and $k = 3$. (Note that $|\omega| = 1$ in all cases). Thus an asymptotic formula for $C(n)$ is

$$\frac{-a_3 n^2}{2}.$$

In fact, we can calculate a_3 as

$$\lim_{z \rightarrow 1} (z-1)^3 R(z) = - \lim_{z \rightarrow 1} \frac{1-z}{1-z^3} \cdot \frac{1-z}{1-z^8} \cdot \frac{1-z}{1-z^{15}} = \frac{-1}{360}$$

Finally, then, we have the asymptotic formula:

$$C(n) \sim \frac{n^2}{720} \quad \square$$

The above example is easily generalized as follows: Suppose we are given any relatively prime set of integers $S = \{a_1, a_2, \dots, a_k\}$ and we would like to find $C(n)$, the number of ways that an arbitrary nonnegative integer n can be expressed as a (nonnegative) integral combination of the elements of S . As in the earlier example, the generating function for $C(n)$ is given by

$$\begin{aligned} \sum_{n=0}^{\infty} C(n)z^n &= (1 + z^{a_1} + z^{2a_1} + \dots)(1 + z^{a_2} + z^{2a_2} + \dots) \dots \\ &\quad \times (1 + z^{a_k} + z^{2a_k} + \dots) \\ &= \frac{1}{1 - z^{a_1}} \cdot \frac{1}{1 - z^{a_2}} \dots \frac{1}{1 - z^{a_k}}. \end{aligned}$$

Thus $C(n)$ is the coefficient of z^n in

$$R(z) = \frac{1}{1 - z^{a_1}} \cdot \frac{1}{1 - z^{a_2}} \dots \frac{1}{1 - z^{a_k}},$$

and we can find $C(n)$ by obtaining the partial fraction decomposition. Again, as in the special case treated above, finding an exact formula for $C(n)$ is rather foreboding. However, to find an asymptotic formula for $C(n)$, we need only establish the following points (whose proofs we leave to the reader):

- (i) R has a pole of order k at $z = 1$.
- (ii) Every other pole of $R(z)$ is of order less than k .
- (iii)

$$\text{The coefficient of } z^n \text{ in } \left(\frac{1}{1-z}\right)^k \text{ is } \binom{n+k-1}{k-1} \sim \frac{n^{k-1}}{(k-1)!}$$

- (iv) The coefficient a_{-k} in the Laurent expansion of $R(z)$ about the point $z = 1$ is $(-1)^k / (a_1 a_2 \dots a_k)$

Combining all of the above gives the general asymptotic formula:

$$C(n) \sim \frac{n^{k-1}}{(k-1)! a_1 a_2 \dots a_k} \quad \square$$

An immediate, but nontrivial, corollary of the above formula is the fact that for sufficiently large values of n , $C(n) > 0$. That is, every “sufficiently large” integer can be expressed as a nonnegative integral combination of the integers in S . This also highlights the necessity of the condition that S be a relatively prime set of integers.

Otherwise, all the elements of S would be multiples of some integer greater than 1, and so would any nonnegative integral combination of the elements of S .

III An Identity of Euler's

Consider expressing n as the sum of *distinct* positive integers, i.e., where repeats are not allowed. (So for $n = 6$, we have the expression $1 + 2 + 3$ as well as $1 + 5$ and $2 + 4$, and just plain 6.)

Also consider expressing n as the sum of positive odd integers, but this time where repeats *are* allowed. (So for $n = 6$, we have $1 + 5$, $3 + 3$, $1 + 1 + 1 + 3$, and $1 + 1 + 1 + 1 + 1 + 1$.) In both cases we obtained four expressions for 6, and a theorem of Euler's says that this is no coincidence.

19.4 Euler's Theorem

The number of ways of expressing n as the sum of distinct positive integers is the same as the number of ways of expressing n as the sum of (not necessarily distinct) odd positive integers.

Proof

To prove the theorem, we produce two generating functions. The latter is exactly the "coin-changing" function where the coins have denominations $1, 3, 5, 7, \dots$. This generating function is given by

$$\frac{1}{(1-z)(1-z^3)(1-z^5)\cdots}$$

Note that the infinite product in the denominator converges uniformly on compacta and represents a nonzero analytic function for $|z| < 1$.

The other generating function is not of the coin-changing variety because of the distinctness condition. However this generating function is the product

$$(1+z)(1+z^2)(1+z^3)\cdots$$

for, when these are multiplied out, each of the various terms which contribute to any particular power in the product is comprised of a product of *distinct* powers. Euler's theorem in its analytic form is then just the identity

$$\frac{1}{(1-z)(1-z^3)(1-z^5)\cdots} = (1+z)(1+z^2)(1+z^3)\cdots \quad (8)$$

throughout $|z| < 1$.

To prove this identity, note that the product on the right can be expressed as

$$\prod_{k=1}^{\infty} (1+z^k) = \prod_{k=1}^{\infty} \frac{1-z^{2k}}{1-z^k}$$

But since the factors in the numerator, and those in the denominator, each determine a convergent infinite product, we can also express the above product as

$$\frac{\lim_{N \rightarrow \infty} \prod_{k=1}^N (1 - z^{2k})}{\lim_{N \rightarrow \infty} \prod_{k=1}^N (1 - z^k)} = \frac{\lim_{N \rightarrow \infty} \prod_{k=1}^N (1 - z^{2k})}{\lim_{N \rightarrow \infty} \prod_{k=1}^{2N} (1 - z^k)} = \lim_{N \rightarrow \infty} \frac{1}{\prod_{k=1}^N (1 - z^{2k-1})}$$

which is precisely the expression on the left side of (8). □

IV Another “Splitting” Problem

Can we split the nonnegative integers into two sets A and B so that every nonnegative integer n can be expressed the same number of ways as the sum of two *distinct* members of A , as it can as the sum of two *distinct* members of B ? If we experiment a bit and begin by placing 0 in A , then $1 \in B$, otherwise 1 would be expressible as $a + a'$ but not as $b + b'$. Similarly $2 \in B$ and $3 \in A$ (why?). Continuing in this manner we find that if the sets A and B exist, then $A = \{0, 3, 5, 6, 9, \dots\}$ and $B = \{1, 2, 4, 7, 8, \dots\}$. But there is no obvious pattern, nor do we have any assurance that A and B even exist. So we turn to generating functions. Let

$$A(z) = \sum_{n \in A} z^n \text{ and } B(z) = \sum_{n \in B} z^n$$

and let $a(n)$ and $b(n)$ denote the number of ways that n can be expressed as the sum of distinct members of A and B , respectively. (To be precise, we will assume that order does not count so that, for example, $a(6) = b(6) = 1$, rather than 2. Of course, if we counted order, it would have no effect on the problem of determining A and B .) Then the generating function for $\{a(n)\}$ is $\frac{1}{2}[A^2(z) - A(z^2)]$. So if A and B exist, they must satisfy

$$\frac{1}{2} [A^2(z) - A(z^2)] = \frac{1}{2} [B^2(z) - B(z^2)] \tag{9}$$

In addition, since A and B partition the integers,

$$A(z) + B(z) = \frac{1}{1 - z} \tag{10}$$

Combining (9) and (10) shows that

$$[A(z) - B(z)] \cdot \frac{1}{1 - z} = A(z^2) - B(z^2)$$

or

$$A(z) - B(z) = (1 - z) [A(z^2) - B(z^2)] \tag{11}$$

Now, (11) can be iterated, giving

$$A(z^2) - B(z^2) = (1 - z^2) \left[A(z^4) - B(z^4) \right]$$

and, applying (11) once again,

$$A(z) - B(z) = (1 - z)(1 - z^2) \left[A(z^4) - B(z^4) \right]$$

Continuing in this manner, we have

$$A(z) - B(z) = (1 - z)(1 - z^2) \cdots (1 - z^{2^{n-1}}) \left[A(z^{2^n}) - B(z^{2^n}) \right]$$

Finally, letting $n \rightarrow \infty$, and using the facts that $z^n \rightarrow 0$, $A(0) = 1$, and $B(0) = 0$, we have

$$A(z) - B(z) = \prod_{k=1}^{\infty} (1 - z^{2^k}) \tag{12}$$

Expanding the above shows that

$$A(z) - B(z) = 1 - z - z^2 + z^3 - z^4 + z^5 \cdots = \sum_{n=0}^{\infty} (-1)^{d(n)} z^n$$

where $d(n)$ is equal to the number of 1's in the binary representation of the integer n . The above identity, together with (10), implies that if the sets A and B exist (and if we assume $0 \in A$), then A consists of all nonnegative integers whose binary representations contain an even number of 1's, while B consists of those integers whose binary form has an odd number of 1's. So the solution, if it exists, is unique. But do the sets described above actually provide a solution to the original problem? In other words, if $r_A(n)$ and $r_B(n)$ denote the number of representations of n as the sum of two distinct integers of A and B , respectively, is $r_A(n) = r_B(n)$ for all n ?

Fortunately, now that the generating functions have revealed the nature of the sets A and B , it is easy to see that the answer to the above question is YES! In fact, we can establish a 1 - 1 correspondence between sums of the form $a + a'$ and those of the form $b + b'$, which equal the same number n , as follows. In the binary representations of a and of a' , simply switch the 1 and the 0 in the first binary digit where they differ. For example, the number 12 is equal to the two sums $12 + 0$ and $9 + 3$, whose terms all belong to A . However we can also obtain representations of 12 of the form $b + b'$ by noting that $12 + 0 = (1100)_2 + (0000)_2 = (1000)_2 + (0100)_2 = 8 + 4$, and $9 + 3 = (1001)_2 + (0011)_2 = (1011)_2 + (0001)_2 = 11 + 1$. \square

As an aside, it might be interesting to determine all integers for which $r_A(n) = r_B(n) = 0$. We leave it to the reader to verify that for $n > 4$, those are precisely the integers of the form $2^{2k+1} - 1$; that is, those integers whose binary representation consists of a single string of an odd number of 1's.

19.5 An Analytic Proof of The Prime Number Theorem

We conclude (this chapter and our textbook) with an analytic proof of the famous prime number theorem.

19.5 Prime Number Theorem

Let $\pi(N)$ denote the number of primes less than or equal to N . Then $\pi(N) \sim \frac{N}{\log N}$. That is,

$$\frac{\pi(N) \log N}{N} \rightarrow 1 \text{ as } N \rightarrow \infty.$$

Riemann seems to have been the first person to note the connection between the zeta function and the prime number theorem. The first complete proofs of the theorem, however, were not given until 1896, when de la Vallée Poussin and Hadamard each gave a complete but complicated “analytic” proof. The proof below is based on some key results concerning the zeta function along with an ingenious lemma of Chebychev and an application of Cauchy’s theorem.

The properties of the zeta function which we will use are

- (1) Euler’s Identity: $\zeta(z) = 1 / \prod_{p \text{ prime}} (1 - 1/p^z)$ if $\operatorname{Re} z > 1$ (See section 18.3)
- (2) $(z - 1)\zeta(z)$ is analytic and zero-free for $\operatorname{Re} z \geq 1$. (See theorems 18.9 and 18.10)

According to (1), if $\operatorname{Re} z > 1$

$$\begin{aligned} \log \zeta(z) &= - \sum_{p \text{ prime}} \log\left(1 - \frac{1}{p^z}\right) = \sum_{p \text{ prime}} \left[\frac{1}{p^z} + \frac{1}{2p^{2z}} + \frac{1}{3p^{3z}} + \cdots \right] \\ &= \sum_{p \text{ prime}, n \geq 1} \frac{1}{np^{nz}} \end{aligned}$$

Note, moreover, that

$$\sum_{p \text{ prime}, n \geq 2} \frac{1}{np^{nz}} = \sum_{p \text{ prime}} \left[\frac{1}{2p^{2z}} + \frac{1}{3p^{3z}} + \cdots \right]$$

is analytic for $\operatorname{Re} z > \frac{1}{2}$ (see Exercise 9). So the function

$$L(z) = \sum_{p \text{ prime}} \frac{1}{p^z} = \log \zeta(z) - \sum_{p \text{ prime}, n \geq 2} \frac{1}{np^{nz}} \quad (3)$$

is also analytic for $\operatorname{Re} z > 1$. In addition, since

$$\log \zeta(z) + \log(z - 1)$$

is analytic for $\operatorname{Re} z \geq 1$ (see (2) above), so is the function $L(z) + \log(z - 1)$ as well as

$$L'(z) + \frac{1}{z-1} = \sum_{p \text{ prime}} \frac{-\log p}{p^z} + \frac{1}{z-1} \quad (4)$$

Our proof will center on two functions: One is the analytic function

$$\phi(z) = \sum_{p \text{ prime}} \frac{\log p}{p^z}.$$

So, for future reference, note that, according to (4),

19.6 Lemma

If $\phi(z) = \sum_{p \text{ prime}} \frac{\log p}{p^z}$, then

$$\phi(z) - \frac{1}{z-1}$$

is analytic for $\operatorname{Re} z \geq 1$. □

The other function which plays a critical part in our proof is defined for positive real values x as $\theta(x) = \sum_{p \leq x} \log p$. There are several equivalent versions of the prime number theorem. The one below, involving $\theta(x)$, is very straightforward.

19.7 Lemma

The prime number theorem is equivalent to the assertion that $\theta(x) \sim x$.

Proof

Note that, on the one hand,

$$\theta(x) = \sum_{p \leq x} \log p \leq \sum_{p \leq x} \log x = \pi(x) \log x$$

while, on the other hand, for any $\varepsilon > 0$,

$$\theta(x) \geq \sum_{x^{1-\varepsilon} < p \leq x} \log p \geq \sum_{x^{1-\varepsilon} < p \leq x} (1-\varepsilon) \log x = (1-\varepsilon) \log x \left[\pi(x) - \pi(x^{1-\varepsilon}) \right]$$

Since, obviously, $\pi(x^{1-\varepsilon}) \leq x^{1-\varepsilon}$, the two above inequalities combine to give

$$\frac{\theta(x)}{x} \leq \frac{\pi(x) \log x}{x} \leq \frac{1}{1-\varepsilon} \left[\frac{\theta(x)}{x} \right] + \frac{\log x}{x^\varepsilon}$$

and the lemma follows by letting $x \rightarrow \infty$. □

Chebychev was well aware of the importance of $\theta(x)$ to the proof of the prime number theorem. While he was unable to prove that $\theta(x) \sim x$, he was able to prove

that, for sufficiently large x , $0.92 < \frac{\theta(x)}{x} < 1.11$, which gave the corresponding double inequality for $\frac{\pi(x) \log x}{x}$. We will not prove this double inequality, but we will use the following weaker result obtained by Chebychev.

19.8 Lemma (Chebychev)

$$\theta(x) < x \log 16$$

Proof

Note that $\binom{2n}{n}$ is an integer whose prime factorization contains every prime number in the closed interval $[n+1, 2n]$ and hence $\prod_{n < p \leq 2n} p \leq \binom{2n}{n}$. On the other hand, $\binom{2n}{n}$ is only one of the terms in the binomial expansion of $(1+1)^{2n} = \binom{2n}{0} + \binom{2n}{1} + \cdots + \binom{2n}{2n}$, so that $\binom{2n}{n} \leq 4^n$. Combining the two inequalities shows that $\prod_{n < p \leq 2n} p \leq 4^n$, and taking the logarithm of both sides:

$$\sum_{n < p \leq 2n} \log p \leq n \log 4. \quad (5)$$

Adding inequality (5) with $n = 1, 2, 4, \dots, 2^M$ where M is the least integer for which $2^{M+1} \geq x$, shows then that

$$\theta(x) \leq \sum_{1 < p \leq 2^{M+1}} \log p < 2^{M+1} \log 4 < 2x \log 4. \quad \square$$

Note that, for $\operatorname{Re} z > 1$,

$$\phi(z) = \sum_p \frac{\log p}{p^z} = \int_1^\infty \frac{d\theta(x)}{x^z} = z \int_1^\infty \frac{\theta(x)}{x^{z+1}} dx = z \int_0^\infty e^{-zt} \theta(e^t) dt$$

since $\frac{\theta(x)}{x^z} = 0$ for $x = 1$, and $\lim_{x \rightarrow \infty} \frac{\theta(x)}{x^z} = 0$, according to Lemma 19.8. Hence

$$\frac{\phi(z+1)}{z+1} = \int_0^\infty e^{-(z+1)t} \theta(e^t) dt \quad (6)$$

and subtracting the identity: $\frac{1}{z} = \int_0^\infty e^{-zt} dt$ from (6) yields

$$\frac{\phi(z+1)}{z+1} - \frac{1}{z} = \int_0^\infty e^{-zt} [\theta(e^t) e^{-t} - 1] dt$$

Let $g(z) = \frac{\phi(z+1)}{z+1} - \frac{1}{z}$, and $f(t) = \theta(e^t)e^{-t} - 1$. Then

- (i) $g(z) = \int_0^\infty e^{-zt} f(t) dt$
- (ii) $g(z)$ is analytic for $\operatorname{Re} z \geq 0$. This follows since Lemma 19.6 asserts that $\phi(z+1)$ has a simple pole with residue 1 at $z = 0$, and the same is obviously true for $\frac{\phi(z+1)}{z+1}$.
- (iii) $f(t)$ is bounded (according to Lemma 19.6) and locally integrable.

According to the Analytic Theorem below, then,

$$\int_0^\infty f(t) dt = \int_0^\infty [\theta(e^t)e^{-t} - 1] dt = \int_1^\infty \frac{\theta(x) - x}{x^2} dx \text{ converges.} \quad (7)$$

19.9 Analytic Theorem

Let $f(t)$, $t \geq 0$, be a bounded and locally integrable function and suppose that $g(z) = \int_0^\infty e^{-zt} f(t) dt$, $\operatorname{Re} z > 0$, extends analytically to $\operatorname{Re} z \geq 0$. Then $\int_0^\infty f(t) dt$ exists (and equals $g(0)$).

Proof

For $T > 0$, set $g_T(z) = \int_0^T e^{-zt} f(t) dt$. g is clearly an entire function. What we must show is that $\lim_{T \rightarrow \infty} g_T(0) = g(0)$.

Let R be large and let C be the boundary of the region $\{z : |z| \leq R, \operatorname{Re} z \geq -\delta\}$, where $\delta = \delta(R) > 0$ is small enough so that $g(z)$ is analytic inside and on C . Then

$$g(0) - g_T(0) = \frac{1}{2\pi i} \int_C (g(z) - g_T(z)) e^{zT} \left(1 + \frac{z^2}{R^2}\right) \frac{dz}{z}$$

by Cauchy's Theorem. On the semicircle $C_+ = C \cap \{z : \operatorname{Re} z > 0\}$ the integrand is bounded by $2B/R^2$, where $B = \max_{t \geq 0} |f(t)|$, because

$$|g(z) - g_T(z)| = \left| \int_T^\infty e^{-zt} f(t) dt \right| \leq B \int_T^\infty |e^{-zt}| dt = \frac{B e^{-T \operatorname{Re} z}}{\operatorname{Re} z}$$

while

$$|e^{zT}| = e^{T \operatorname{Re} z} \text{ and } \left| 1 + \frac{z^2}{R^2} \right| = \left| \frac{z\bar{z} + z^2}{R^2} \right| = \frac{|z + \bar{z}|}{R} = \frac{2 \operatorname{Re} z}{R}.$$

So, by the familiar $M - L$ formula, the contribution to $g(0) - g_T(0)$ from the integral over C_+ is bounded in absolute value by $\frac{B}{R}$.

For the integral over $C_- = C \cap \{z : \operatorname{Re} z < 0\}$, we look at the terms involving $g(z)$ and $g_T(z)$ separately. Since g_T is entire, the path of integration for the term involving g_T can be replaced by the semicircle $C'_- = \{z : |z| = R \text{ and } \operatorname{Re} z < 0\}$. The contribution to $g(0) - g_T(0)$ from the integral along this semicircle is also bounded by B/R , since

$$|g_T(z)| = \left| \int_0^T e^{-zt} f(t) dt \right| \leq B \int_{-\infty}^T |e^{-zt}| dt = \frac{B e^{-T \operatorname{Re} z}}{|\operatorname{Re} z|}, \operatorname{Re} z < 0.$$

Finally, the remaining integral over C_- tends to 0 as $T \rightarrow \infty$ because the integrand is the product of the function $g(z)(1 + z^2/R^2)/z$, which is independent of T , and the function e^{zT} , which goes to 0 rapidly and uniformly on compact sets as $T \rightarrow \infty$ in the half-plane $\text{Re } z < 0$. For example, we can choose T large enough so that $\frac{1}{\sqrt{T}} < \delta$, and then split C_- into two parts: $C_-^1 = \{z \in C_- : \text{Re } z \geq \frac{-1}{\sqrt{T}}\}$ and $C_-^2 = \{z \in C_- : \text{Re } z < \frac{-1}{\sqrt{T}}\}$. The integral over C_-^1 is bounded by $M - L$, where

$$M = \text{Max} |g(z)| \text{ for } z \in C_-$$

and $L =$ the length of C_-^1 , which is bounded above by $\frac{4}{\sqrt{T}}$. The integral over C_-^2 is bounded by $\pi R M e^{-\sqrt{T}}$. Hence

$$\limsup_{T \rightarrow \infty} |g(0) - g_r(0)| \leq 2B/R$$

and since R is arbitrary, the proof is complete. □

We now complete the proof of the Prime Number Theorem by showing that the convergence of the integral in (7) guarantees that $\theta(x) \sim x$.

19.10 Lemma

Suppose $h(x)$ is a non-decreasing function and

$$\int_1^\infty \frac{h(x) - x}{x^2} dx \tag{8}$$

converges. Then $h(x) \sim x$.

Proof

Assume that for some $\lambda > 1$, there are arbitrarily large values of x with $h(x) \geq \lambda x$. Then

$$\int_x^{\lambda x} \frac{h(t) - t}{t^2} dt \geq \int_x^{\lambda x} \frac{\lambda x - t}{t^2} dt = \int_1^\lambda \frac{\lambda - t}{t^2} dt > 0$$

for all such x , contradicting (8). Similarly, the inequality $h(x) \leq \lambda x$ with $\lambda < 1$ would imply

$$\int_{\lambda x}^x \frac{h(t) - t}{t^2} dt \leq \int_x^{\lambda x} \frac{\lambda x - t}{t^2} dt = \int_1^\lambda \frac{\lambda - t}{t^2} dt < 0$$

which, according to (8), cannot be true for a fixed λ and arbitrarily large values of x . □

Exercises

1. Show that $\tan z = z$ has only real solutions.
2. With C_N as in 19.1, use the fact that

$$f_2(z) = \frac{z^2}{(1+z^2)(\tan z - z)} \sim -\frac{1}{z}$$

to conclude $\int_{C_N} f_2(z) dz \rightarrow -2\pi i$. (Compare with 12.1, Example 3.) Conclude that

$$\text{Var}\left(\frac{\sin^2 x}{x^2}\right) = e^2 - 5$$

by considering the various contributions to

$$\lim_{N \rightarrow \infty} \int_{C_N} f_2(z) dz.$$

3. Recall (Section 16.2) that $e^z = z$ has infinitely many solutions z_k ; $k = 1, 2, \dots$. Find $\sum_{k=1}^{\infty} 1/z_k^2$.
4. Find all solutions to the system of equations in 19.3 if we require only $a_k, b_k \geq 0$ for all k .
5. Show that the positive integers cannot be partitioned into a finite number of arithmetic progressions if one of the differences is relatively prime to the others.
- 6.* (The following exercise shows how generating functions can be used to "solve a difference equation"; i.e., to find an explicit form for a recursively-defined sequence.) Suppose a sequence is defined recursively by $c_0 = c_1 = 1$ and $c_{n+2} = c_{n+1} + 2c_n$ for $n \geq 0$. Let $F(z) = \sum_{n=0}^{\infty} c_n z^n$.
 - a. Prove by induction that $c_n \leq 3^n$, and hence show that the radius of convergence of $F(z) \geq \frac{1}{3}$.
 - b. Show that $(1 - z - 2z^2)F(z) = 1$, and express $F(z)$ as a sum of two simple rational functions.
 - c. Find (a closed form) for the sequence of coefficients $\{c_n\}$
- 7.* Let $c_n = 1^2 + 2^2 + \dots + n^2$, and $F(z) = \sum_{n=1}^{\infty} c_n z^n$. Show that $(1 - z)F(z) = \sum_{n=1}^{\infty} n^2 z^n$ and thereby obtain a closed form for c_n .
- 8.* Use the method outlined in 19.4 II to find a formula for $C(n)$, the number of ways of expressing the positive integer n as a nonnegative integral combination of 3's and 4's.
9. Prove

$$\sum_{\substack{p \text{ prime} \\ n \geq 2}} \frac{1}{np^{nz}}$$

is analytic in $\text{Re } z > \frac{1}{2}$. [Hint: Show

$$\sum_{\substack{n \geq 2 \\ p \text{ prime}}} \left| \frac{1}{np^{nz}} \right| < \sum_{p \text{ prime}} \frac{2}{p^{2x}}.]$$

Answers

Chapter 1

- $\frac{3}{20} - \frac{1}{20}i$.
 - $\frac{-3}{2} + \frac{11}{2}i$.
 - $\frac{-1}{2} + \frac{\sqrt{3}}{2}i$.
 - $-1, -i, 1, i, \dots$
- $\pm(1 + 3i)$.
- $1 + (3 - \sqrt{8})i; -1 - (3 + \sqrt{8})i$.
- b., d.: Let $z_1 = x_1 + iy_1$, $z_2 = x_2 + iy_2$, etc.
 - Use properties (a), (b) and the fact that a real number is its own conjugate.
- Use Exercise (4c): $P(\bar{z}) = \overline{P(z)}$.
- If $z = x + iy = re^{i\theta}$, then $z^2 = x^2 - y^2 + 2ixy = r^2 e^{2i\theta}$, etc.
- (c) Equality occurs if, and only if, $\operatorname{Re} z$ or $\operatorname{Im} z = 0$.
- (b) $|z_1 + z_2| = |z_1| + |z_2|$ if, and only if, $\operatorname{Re}(z_1 \bar{z}_2) = |z_1||z_2|$, i.e., if, and only if, $z_1 \bar{z}_2$ is a real number, or, equivalently, $\operatorname{Arg} z_1 = \operatorname{Arg} z_2$.
- Note that \tan^{-1} is always between $\frac{-\pi}{2}$ and $\frac{\pi}{2}$ whereas $\operatorname{Arg} z$ takes values (*modulo* 2π) in the interval 0 to 2π .
- $1, \operatorname{cis} \frac{\pi}{3}, \operatorname{cis} \frac{2\pi}{3}, -1, \operatorname{cis} \frac{4\pi}{3}, \operatorname{cis} \frac{5\pi}{3}$.
 - $\operatorname{cis} \theta; \theta = \frac{\pi}{4}, \frac{3\pi}{4}, \frac{5\pi}{4}, \frac{7\pi}{4}$.
 - $2^{1/4} \operatorname{cis} \theta; \theta = \frac{\pi}{6}, \frac{2\pi}{3}, \frac{7\pi}{6}, \frac{5\pi}{3}$.
- Note that the n th roots of unity are all zeroes of $z^n - 1 = (z - 1)(z^{n-1} + z^{n-2} \dots + 1)$.
- Using (13) and the fact that $z^n - 1 = (z - z_1)(z - z_2) \cdots (z - z_n)$ where z_1, z_2, \dots, z_n are the n th roots of unity, we have (assuming $z_1 = 1$)

$$z^{n-1} + z^{n-2} + \cdots + 1 = (z - z_2) \cdots (z - z_n)$$

Let $z = 1$, and consider the absolute value of the two sides of the above equation.

- Closed disc centered at i with radius 1; not a region.
 - The imaginary axis; not a region.
 - The open half-plane: $\operatorname{Re} z > 5/2$; a region.
 - The upper half of the unit disc, centered at the origin; a region.
 - The unit circle centered at the origin; not a region.
 - The circle centered at $\frac{1}{2}i$ with radius $\frac{1}{2}$; not a region.

g. The set of points satisfying $r^2 < 2 \cos 2\theta$, $r \neq 0$; not connected and, therefore, not a region.

17. $\operatorname{Arg} \left(\frac{z-1}{z+1} \right) = \operatorname{Arg}(z-1) - \operatorname{Arg}(z+1)$. Consider the diagram below for $\operatorname{Re} z > 0$ and an analogous argument for $\operatorname{Re} z < 0$.

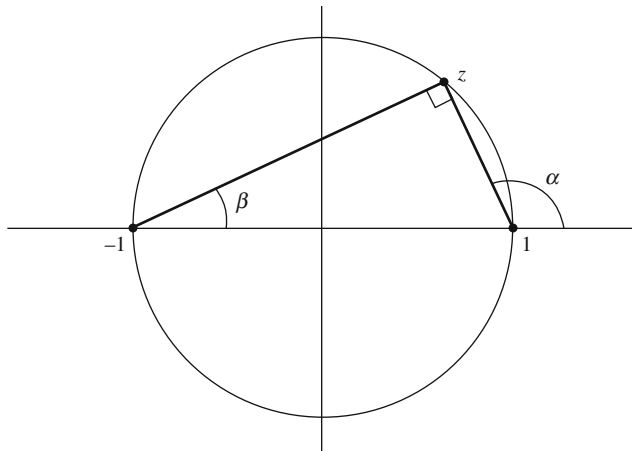

21. a. For $|z| \leq r < 1$, $\sum |kz^k| < \sum kr^k < \infty$. Apply Theorem 1.9.
 b. For $\operatorname{Re} z \geq 0$, $\sum \left| \frac{1}{k^2+z} \right| \leq \sum \frac{1}{k^2}$. Apply Theorem 1.9.
22. Assume S is polygonally connected, and S is “disconnected” by open sets A and B with $a \in A$, $b \in B$. Consider the polygonal line $L(t)$, $0 \leq t \leq 1$, connecting a and b , and let $c = L(t_0)$, $t_0 = \sup\{t_1 : L(t) \in A, 0 \leq t \leq t_1\}$. Then, $c \in A$, but, because A is open, so is $L(t_0 + \delta)$, unless $c = b$.
23. Note that no curve in S (of finite length) can connect a point of S , not on the y axis, with a point on the y axis. Nevertheless, S cannot be “disconnected” because any open set which contains a point of the form $(0, t)$, $-1 < t < 1$, would also have to contain points of the form $y = \sin \frac{1}{x}$, $x > 0$.
24. $\zeta \geq \zeta_0 \Rightarrow x^2 + y^2 \geq \frac{\zeta_0}{1-\zeta_0}$
25. $A(x^2 + y^2) + Bx + Cy + D = 0$ is equivalent to $A \left(\frac{\zeta}{1-\zeta} \right) + B\zeta \left(\frac{1}{1-\zeta} \right) + C\eta \left(\frac{1}{1-\zeta} \right) + D = 0$ or $A\zeta + B\zeta + C\eta + D(1-\zeta) = 0$, $\zeta \neq 1$. Consider $A = 0$ and $A \neq 0$.
26. If $P(z) = a_n z^n + a_{n-1} z^{n-1} + \cdots + a_0$, $a_n \neq 0$, then $P(z) = z^n \left(a_n + \frac{a_{n-1}}{z} + \cdots + \frac{a_0}{z^n} \right)$, etc.
27. a. Use formulas (3) for (ζ, η, ζ') and the fact that $\frac{1}{z} = \frac{1}{x+iy} = \frac{x}{x^2+y^2} - \frac{iy}{x^2+y^2}$ to show that $(\zeta', \eta', \zeta') = (\zeta, -\eta, 1-\zeta)$.
 b. Consider the corresponding points on \sum and apply 27 (a).
28. Note that according to (27), $A\zeta + B\eta + C\zeta = D$ is equivalent to $A\zeta' - B\eta' - C\zeta' = D - C$.

Chapter 2

- For $P(x, y) = (x + iy)^n$, $P_x = n(x + iy)^{n-1}$ and $P_y = in(x + iy)^{n-1}$.
- a. Analytic: $P(z) = z^3 - z$.
b. Not analytic.
c. Analytic: $P(z) = -iz^2$.
- $P_y = iP_x$ would imply $P_y \equiv P_x \equiv 0$ because both P_y and P_x would be imaginary.
- In (3a), $P'(z) = 3z^2 - 1 = 3x^2 - 3y^2 - 1 + i6xy$. In (3c), $P'(z) = -2iz = 2y - 2ixy$.
- Use the usual properties of limits, etc.
- $\lim_{h \rightarrow 0} \frac{(z+h)^n - z^n}{h} = \lim_{h \rightarrow 0} [(z+h)^{n-1} + (z+h)^{n-2}z + \cdots + z^{n-1}] = nz^{n-1}$
- $\log S_n = \frac{\log n}{n} \rightarrow 0$ as $n \rightarrow \infty$, so $S_n = e^{\log S_n} \rightarrow 1$.
- a. 1. b. $1/2$.
- a. R . b. R . c. R^2 .
- The radius of convergence must be greater than or equal to $\min(R_1, R_2)$. It may exceed both if, e.g., $b_n = -a_n$ for all n and $R_1, R_2 < \infty$.
- Use the facts that $\sum \frac{\sin n\theta}{n}$ converges for all θ and $\sum \frac{\cos n\theta}{n}$ converges for $\theta: 0 < \theta < 2\pi$ (both can be proven by Dirichlet's Test).
- a. Write $a_n = a_1 \left(\frac{a_2}{a_1}\right) \cdots \left(\frac{a_n}{a_{n-1}}\right)$ and note that, according to the hypothesis, for any $\epsilon > 0$, there is some k such that $j > k \Rightarrow \left| \frac{a_j}{a_{j-1}} - L \right| < \epsilon$. Thus, $M_k(L - \epsilon)^{n-k} < a_n < M_k(L + \epsilon)^{n-k}$, etc.
b. Note that, for $a_n = \frac{1}{n!}$, $\frac{a_{n+1}}{a_n} = \frac{1}{n+1}$ and apply (13a).
- a. ∞ . b. ∞ . c. e . d. ∞ .
- If $\sum |a_k|$ and $\sum |b_k|$ converge and if $d_k = \sum_{j=0}^k |a_j||b_{k-j}|$, then, clearly, $\sum_{k=0}^n d_k \leq \sum_{k=0}^n |a_k| \cdot \sum_{k=0}^{\infty} |b_k| \leq \sum_{k=0}^{\infty} |a_k| \sum_{k=0}^{\infty} |b_k|$ so that $\sum d_k$ converges. Moreover $A_n B_n = C_n + R_n$ where $|R_n| = \sum_{n < k+j \leq 2n} a_k b_j \leq d_{n+1} + d_{n+2} + \cdots + d_{2n}$, etc.
- Use the fact that $\sum a_n z^n$ and $\sum b_n z^n$ converge absolutely within their circles of convergence and apply Exercise (17).
- a. Let $N \rightarrow \infty$ in the identity

$$(1 - z)(1 + z + z^2 + \cdots + z^N) = 1 - z^{N+1}$$
- $(\sum_{n=0}^{\infty} z^n) (\sum_{n=0}^{\infty} z^n) = \sum_{n=0}^{\infty} (n+1)z^n = \frac{1}{(1-z)^2}$ so that

$$\sum_{n=0}^{\infty} n z^n = \frac{1}{(1-z)^2} - \frac{1}{(1-z)} = \frac{z}{(1-z)^2}.$$
- If S has an accumulation point at 0, we can find $z_1 \in S$ with $|z_1| < 1$, $z_2 \in S$ with $|z_2| \leq \frac{1}{2}|z_1|$, etc.
- If $f(z) = 1$ for $z = \frac{1}{2}, \frac{1}{3}, \frac{1}{4}, \dots$, by (2.13), $f \equiv 1$ and $f' \equiv 0$.
- Let $g(z) = f(z + \alpha) = \sum C_n z^n$. Then, $C_n = \frac{g^{(n)}(0)}{n!} = \frac{f^{(n)}(\alpha)}{n!}$.

23. a. $|z - i| < 1$.
 b. all z .
 c. $\left|z - \frac{1}{2}\right| < \frac{1}{2}$.

Chapter 3

- $$f_x = \lim_{\substack{h \rightarrow 0 \\ h \text{ real}}} \frac{f(x+h, y) - f(x, y)}{h} = \lim_{\substack{h \rightarrow 0 \\ h \text{ real}}} \frac{f(z+h) - f(z)}{h}$$

$$f_y = \lim_{\substack{h \rightarrow 0 \\ h \text{ real}}} \frac{f(x, y+h) - f(x, y)}{h} = \lim_{\substack{h \rightarrow 0 \\ h \text{ real}}} \frac{f(z+ih) - f(z)}{h}$$
- $f_y = 2iy = if_x = 2ix$ if, and only if, $y = x$.
- The equality in the hint follows from the differentiability of g at $f(z)$. Divide both sides by h to complete the argument.
- Because $\frac{g^2(z) - g^2(z_0)}{z - z_0} = 1$, $\frac{g(z) - g(z_0)}{z - z_0} = \frac{1}{g(z) + g(z_0)}$, so that $\lim_{z \rightarrow z_0} \frac{g(z) - g(z_0)}{z - z_0} = \frac{1}{2g(z_0)}$ by the continuity of g at z_0 .
- Note that $f_x \equiv f_y \equiv 0$, and apply Theorem 1.10.
- Note that $[f^2(z)]' = 2f(z)f'(z) \equiv 0$.
- If f maps a region into a straight line or into a circular arc, then there are constants A, B so that $g(z) = Af(z) + B$ maps the region into the imaginary axis or into a circle centered at the origin, respectively. But, then, according to Propositions 3.6 and 3.7, g is constant, and so is f .
- $f(x, y) = x^2 - y^2 + 2ixy + iC = z^2 + iC$, where C is a real constant.
- Note that the Cauchy-Riemann equations cannot be satisfied.
- The Cauchy-Riemann equation $u_x = v_y$ implies, in this case, that $u'(x) = v'(y)$. Because $u'(x)$ is a function of x alone and $v'(y)$ is a function of y alone, both $u'(x)$ and $v'(y)$ are constants; in fact, $u'(x) = v'(y) = a$ and $f(z) = u + iv = az + b$.
- Because $u = e^x \cos y$ and $v = e^x \sin y$, $u_x = v_y = e^x \cos y$ and $u_y = -v_x = -e^x \sin y$.
 - With $z_1 = x_1 + iy_1$, $z_2 = x_2 + iy_2$

$$e^{z_1 + z_2} = e^{x_1 + x_2} [\cos(y_1 + y_2) + i \sin(y_1 + y_2)] = e^{x_1} (\cos y_1 + i \sin y_1) \cdot e^{x_2} (\cos y_2 + i \sin y_2) = e^{z_1} e^{z_2}.$$
- $|e^z| = \sqrt{e^{2x} \cos^2 y + e^{2x} \sin^2 y} = e^x$
- $e^z = e^x e^{iy} \rightarrow \infty$ if $x \rightarrow +\infty$ (i.e., along rays in the right half-plane). $e^z \rightarrow 0$ if $x \rightarrow -\infty$ (i.e., along rays in the left half-plane). On the imaginary axis, $e^z = e^{iy}$ traverses the unit circle infinitely often.
- $2\pi ki$; k any integer.
 - $(\frac{\pi}{2} + 2\pi k)i$.
 - $\ln 3 + (2k + 1)\pi i$.
 - $\frac{1}{2} \ln 2 + (\pi/4 + 2\pi k)i$.

15. a. $2 \sin z \cos z = 2 \left[\frac{1}{2i} (e^{iz} - e^{-iz}) \frac{1}{2} (e^{iz} + e^{-iz}) \right] = \frac{1}{2i} (e^{2iz} - e^{-2iz}) = \sin 2z$.
- b. $\cos^2 z + \sin^2 z = \frac{1}{4} (e^{iz} + e^{-iz})^2 - \frac{1}{4} (e^{iz} - e^{-iz})^2 = 1$
- c. $(\sin z)' = \frac{1}{2i} (ie^{iz} + ie^{-iz}) = \cos z$.
17. $-\sin z$.
18. $z = \left(\frac{\pi}{2} + 2\pi k\right) - i \ln(2 \pm \sqrt{3})$, k any integer.
20. $\sin(x + iy) = \frac{1}{2i} (e^{-y+ix} - e^{y-ix}) = \frac{1}{2i} [e^{-y}(\cos x + i \sin x) - e^y(\cos x - i \sin x)] = \frac{1}{2} (e^{-y} \sin x + e^y \sin x) + \frac{i}{2} (e^y \cos x - e^{-y} \cos x) = \sin x \cosh y + i \cos x \sinh y$.
21. $f(z)f(w) = \sum_{n=0}^{\infty} \frac{z^n}{n!} \sum_{n=0}^{\infty} \frac{w^n}{n!} = \sum_{n=0}^{\infty} \left(\sum_{k=0}^n \frac{z^k w^{n-k}}{k!(n-k)!} \right) = \sum_{n=0}^{\infty} \frac{(z+w)^n}{n!} = f(z+w)$.
22. Because $e^{iz} = 1 + iz - \frac{z^2}{2!} - \frac{iz^3}{3!} + \dots$ and $e^{-iz} = 1 - iz - \frac{z^2}{2!} + \frac{iz^3}{3!} + \dots$, $\frac{e^{iz} - e^{-iz}}{2i} = z - \frac{z^3}{3!} + \frac{z^5}{5!} - \dots$.
23. $\cos z = 1 - \frac{z^2}{2!} + \frac{z^4}{4!} - \dots = \sum_{n=0}^{\infty} (-1)^n \frac{z^{2n}}{(2n)!}$

Chapter 4

- Use the facts that a 1-1 C^1 mapping $\lambda(t) : [c, d] \rightarrow [a, b]$ with $\lambda' > 0$ has a 1-1 C^1 inverse $\lambda^{-1} : [a, b] \rightarrow [c, d]$ with $(\lambda^{-1})' > 0$ and, if $\lambda : [c, d] \rightarrow [a, b]$ and $\lambda_2 : [e, f] \rightarrow [c, d]$, then $\lambda_1 \circ \lambda_2 : [e, f] \rightarrow [a, b]$ with all the desired properties of λ_1 and λ_2 .
- $\int_C f(z) dz = \int_0^1 (t^4 + it^4)(2t + i2t) dt = \frac{2}{3} i$. The result is the same as in Example 1, because the curves are equivalent.
- $\int_C f(z) dz = \int_0^{2\pi} \frac{1}{(\sin t + i \cos t)} (\cos t - i \sin t) dt = \int_0^{2\pi} -i dt = -2\pi i$. Note that the curve in this case is in the opposite direction of the curve in Example 2.
- Let $f = u_1 + iv_1$, $g = u_2 + iv_2$, $C : z(t) = x(t) + iy(t)$ and $\alpha = a + bi$, etc.
- $F(b) - F(a) = \int_\gamma F'(z) dz$ where γ is any curve with initial point a and terminal point b .
- As in Lemma 4.9, let $\int_{|z|=1} f(z) dz = \operatorname{Re} i^\theta$ so that $R = \left| \int_{|z|=1} f(z) dz \right| = \int_{|z|=1} e^{-i\theta} f(z) dz$. Note, then, that

$$R = \int_{|z|=1} e^{-i\theta} f(z) dz = \int_0^{2\pi} f(e^{it}) i e^{i(t-\theta)} dt = \int_0^{2\pi} g(t) i e^{i(t-\theta)} dt$$

where $g(t) = f(e^{it})$ is a real-valued function of t

$$= \operatorname{Re} \int_0^{2\pi} g(t) i e^{i(t-\theta)} dt = \int_0^{2\pi} g(t) \sin(\theta - t) dt$$

and because $|g(t)| \leq 1$, $R \leq \int_0^{2\pi} |\sin(\theta - t)| dt = \int_0^{2\pi} |\sin t| dt = 4$.

7. Note that, on any line segment from z_0 to z_1 , i.e., if $\gamma(t) = z_0 + t(z_1 - z_0)$, $0 \leq t \leq 1$, $\int_\gamma 1 dz = z_1 - z_0$ and $\int_\gamma z dz = \frac{z_1^2}{2} - \frac{z_0^2}{2}$, etc.
8. a. Because $z^k = \left(\frac{z^{k+1}}{k+1}\right)'$ and because $\frac{z^{k+1}}{k+1}$ is analytic on C (as long as k is an integer other than -1), by Proposition 4.12, $\int_C z^k dz = 0$.
- b. $\int_C z^k dz = \int_0^{2\pi} R^k e^{ik\theta} i R e^{i\theta} d\theta = i R^{k+1} \int_0^{2\pi} e^{(k+1)i\theta} d\theta = \frac{R^{k+1}}{k+1} e^{(k+1)i\theta} \Big|_{\theta=0}^{2\pi} = 0$.
9. a. $\int_C (z-i) dz = \frac{z^2}{2} - iz \Big|_{-1+i}^{1+i} = 0$.
- b. Let $z(t) = t + i$, $-1 \leq t \leq 1$. $\int_C (z-i) dz = \int_{-1}^1 t dt = 0$.

Chapter 5

1. $z^2 = 4 + 4(z-2) + (z-2)^2$
2. Because all the derivatives of e^z are e^z , $e^z = \sum_{k=0}^{\infty} e^a \frac{(z-a)^k}{k!} = e^a e^{z-a}$
3. a. $f(z) = -f(-z) \Rightarrow f'(z) = f'(-z)$. Hence, the derivative of an odd function is even. Similarly, the derivative of an even function is odd. Furthermore, if f is odd, i.e., if $f(z) = -f(-z)$, it follows that $f(0) = 0$. So, if f is odd,
- $$f(z) = \sum_{\substack{k=1 \\ k \text{ odd}}}^{\infty} \frac{f^{(k)}(0)}{k!} z^k.$$
- b. By analogous reasoning, an even function has only even powers in its power series expansion about 0.
4. According to Theorem 5.5, $C_k = \frac{1}{2\pi i} \int_C \frac{f(w)}{w^{k+1}} dw$ while, according to Corollary 2.11, $C_k = \frac{f^{(k)}(0)}{k!}$.
5. Let $g(z) = f(z+a)$, so that $g^{(k)}(0) = f^{(k)}(a)$, etc., and apply the result of Exercise 4.
6. a. Using Exercise 4 and the $M-L$ formula, $|C_k| \leq \frac{M}{R^k}$.
- b. Apply (6a) with $R = 1$ and $M = 1$ to conclude that $|C_k| \leq 1$ for all k .
7. According to Exercise (6a) $|C_j| \leq \frac{A+BR^k}{R^j}$. Because $j > k$, we conclude that $C_j = 0$ by letting $R \rightarrow \infty$.
8. As in the previous exercise, note that $C_k = 0$ for $k \geq 2$.
9. By Liouville's Theorem, $f'(z)$ is a linear function. Moreover, $|f'(z)| \leq |z| \Rightarrow f'(0) = 0$ so that $f(z) = f(0) + f'(0)z + \frac{f''(0)}{2}z^2 = a + bz^2$ with $|b| = \left| \frac{f''(0)}{2} \right| \leq \frac{1}{2}$ because $f''(0) = \frac{1}{2\pi i} \int_{|w|=1} \frac{f'(w)}{w^2} dw \ll 1$.
10. f is bounded in the compact domain: $0 \leq x \leq 1, 0 \leq y \leq 1$. Moreover, by the two equations of periodicity, for any $z = x + iy$, $f(z) = f(x, y) =$

$f(x - \text{Int}x, y - \text{Int}y)$, where $\text{Int} w$, the integer part of w , is the greatest integer less than or equal to w . Hence, f is bounded throughout the complex plane and must be constant.

11. By the remarks following the Fundamental Theorem of Algebra, a polynomial of odd degree must have an odd number of zeroes (counting multiplicity). According to Exercise 5 of Chapter 1, a *real* polynomial has a zero at the conjugate of any nonreal zero, so that the complex zeroes come in conjugate pairs. Thus, there must be at least one *real* zero.
12. Let $P(z) = a_n z^n + \cdots + a_0 = a_n(z - z_1)(z - z_2) \cdots (z - z_n)$ and note that, if $z_k = a + bi$ and $z_j = a - bi$ are complex conjugates, $(z - z_k)(z - z_j) = z^2 - 2az + (a^2 + b^2)$ is a *real* quadratic polynomial.
13. a. If $v > 0$ for $y > 0$, then we must have $v < 0$ for $y < 0$. (By the Fundamental Theorem of Algebra, $v \geq 0$ for all z is impossible!) Hence $v_y \geq 0$ throughout the real axis. Similarly, if $v < 0$ for $y > 0$, $v_y \leq 0$ throughout the real axis.
 b. Follows from the Cauchy-Riemann equations.
 c. Because $u_x(x, 0)$ is a polynomial in x which is either consistently ≥ 0 or consistently ≤ 0 for all x , $u(x, 0) = \alpha$ cannot have more than one solution. Hence $P(z) = \alpha$ has, at most, one solution for real α and, by the Fundamental Theorem of Algebra, P is a linear polynomial.
14. If $P(z) = (z - \alpha)^k Q(z)$ with $Q(\alpha) \neq 0$, $P'(z) = (z - \alpha)^{k-1} [(z - \alpha)Q'(z) + kQ(z)] = (z - \alpha)^{k-1} R(z)$ with $R(\alpha) \neq 0$. Proceed by induction.
15. Let $f(z) = f(z_0) + \int_{z_0}^z f'(w)dw$ where the path of integration is along the ray from 0 to z , beginning at z_0 , with $z_0 = t_0 z$, where $t_0 = \sup\{t_1 : |f(tz)| \leq 1, 0 \leq t \leq t_1\}$. Clearly, then $|f(z_0)| \leq \max\{1, |f(0)|\}$ and the integral is bounded by $|z|$.

Chapter 6

1. For any complex α ,

$$\begin{aligned} \frac{1}{z} &= \frac{1}{\alpha + (z - \alpha)} = \frac{1}{\alpha \left[1 + \frac{z - \alpha}{\alpha}\right]} \\ &= \frac{1}{\alpha} \left[1 - \frac{(z - \alpha)}{\alpha} + \frac{(z - \alpha)^2}{\alpha^2} - + \cdots \right] \\ &= \sum_{k=0}^{\infty} \frac{(-1)^k (z - \alpha)^k}{\alpha^{k+1}}. \end{aligned}$$

Take $\alpha = 1 + i$.

3. Because $1 + z + z^2 + \cdots = \frac{1}{1-z}$, $1 + 2z + 3z^2 + \cdots = \sum_{n=1}^{\infty} n z^{n-1} = \frac{1}{(1-z)^2}$ and $\sum_{n=1}^{\infty} n z^n = \frac{z}{(1-z)^2}$. Similarly, $\sum_{n=1}^{\infty} n^2 z^{n-1} = \frac{1+z}{(1-z)^3}$ and $\sum_{n=1}^{\infty} n^2 z^n = \frac{z(1+z)}{(1-z)^3}$.

4. If $f(\frac{1}{n}) = \frac{1}{n+1}$, then for all points $z_n = \frac{1}{n}$, $f(z_n) = \frac{1}{\frac{1}{z_n}+1}$ or $f(z_n) = \frac{z_n}{1+z_n}$. Because $\{z_n\}$ has an accumulation point at 0, this implies that $f(z) = \frac{z}{1+z}$ throughout its domain of analyticity which yields a contradiction since f was assumed analytic at $z = -1$.
5. Let z_2 be a fixed real number. Then, $f(z) = \sin(z + z_2)$ and $g(z) = \sin z \cos z_2 + \cos z \sin z_2$ are two entire functions (of z) which agree for all real values $z = z_1$ and, hence, for all complex values $z = z_1$, as well. Let $z = z_1$ be any such complex number. Then, $f(z) = \sin(z_1 + z)$ and $g(z) = \sin z_1 \cos z + \cos z_1 \sin z$ agree for all real values $z = z_2$ and, hence, for all complex values $z = z_2$ as well.
6. If $f(x) = \tan x$, $0 \leq x \leq 1$, $f(z)$ must equal the analytic function $\frac{\sin z}{\cos z}$ throughout the domain of analyticity of $f(z)$. Thus, $f(z) = i \Rightarrow \frac{\sin z}{\cos z} = i \Rightarrow \frac{e^{iz} - e^{-iz}}{2i} = \frac{i(e^{iz} + e^{-iz})}{2} \Rightarrow e^{iz} = 0$, which is impossible.
7. Because $|f(z)| > |z|^N$ for large z , $f(z) \rightarrow \infty$ as $z \rightarrow \infty$ and, hence, f is a polynomial (Theorem 6.11). Moreover, $|f(z)| \geq |z|^N$ for large z implies that the degree of $f(z)$ must be at least N .
8. $g(z) = f(z)f(-z)$ is bounded in modulus by 6 throughout $|z| = 1$. Thus $|g(0)| \leq 6$ and $|f(0)| \leq \sqrt{6}$.
9. $|e^z| = e^x$ so that $\max |e^z|$ occurs at a point in the domain with maximal x and $\min |e^z|$ occurs at a point in the domain with minimal x (i.e., at points farthest to the right and to the left, respectively).
10. Because $z^2 - z = z(z - 1)$, the minimum modulus occurs at $z = 0$ and the maximum modulus (which occurs on the boundary) is assumed at $z = -1$, i.e., $\max_{|z| \leq 1} |z^2 - z| = 2$; $\min_{|z| \leq 1} |z^2 - z| = 0$.
12. Suppose $|f(z)| + |g(z)|$ assumed its maximum at the interior point z_0 (and not on the boundary). Let $f(z_0) = Ae^{-i\alpha}$ and $g(z_0) = Be^{-i\beta}$. Then $h(z) = f(z)e^{i\alpha} + g(z)e^{i\beta}$ would satisfy $h(z_0) = |f(z_0)| + |g(z_0)|$ while $|h(z)| \leq |f(z)| + |g(z)| < |h(z_0)|$ throughout the boundary. Thus, the analytic function $h(z)$ would assume its maximum at the interior point z_0 (and not on the boundary) which is impossible.
13. If $P(z) \neq 0$, then, the minimum modulus of $P(z)$ in $|z| \leq R$ would have to occur on the boundary. However, because $P(z) \rightarrow \infty$ as $z \rightarrow \infty$, we could choose R so that $|P(z)| > |P(0)|$ for all $|z| = R$, yielding a contradiction.
14. According to Exercise (6b) of Chapter 5 $P(z) = a_0 + a_1z + \cdots + a_nz^n$ with $|a_k| \leq 1$ for $k = 0, 1, \dots, n$. Consider $Q(z) = \frac{P(z)}{z^n}$ in the annulus $1 \leq |z| \leq R$. Throughout $|z| = 1$, $|Q(z)| = |P(z)| \leq 1$ and, if $|z| = R$, $|Q(z)| = |a_n + \frac{a_{n-1}}{z} + \cdots + \frac{a_0}{z^n}| \leq |a_n| + \epsilon_R \leq 1 + \epsilon_R$ where $\epsilon_R \rightarrow 0$ as $R \rightarrow \infty$. Hence, $|Q(z)| = |\frac{P(z)}{z^n}| \leq 1$ for all $z : |z| \geq 1 \Rightarrow |P(z)| \leq |z|^n$.

[NOTE: The related question: What is the maximum value of $P_n(x)$ for real x , given $|P_n(x)| \leq 1$ for $-1 \leq x \leq 1$, can be answered in terms of Chebychev polynomials and is considerably more complicated.]

Chapter 7

1. According to the Open Mapping Theorem, the image under f of any open set D containing z_0 in its interior is an open set containing $f(z_0)$ in its interior. Hence, both $\operatorname{Re} f$ and $\operatorname{Im} f$ assume larger and smaller values in D than the values $\operatorname{Re} f(z_0)$ and $\operatorname{Im} f(z_0)$.
2. Note that continuous functions map connected sets into connected sets and apply the Open Mapping Theorem to complete the argument.
3. a. By the Open Mapping Theorem, if $f(z)$ is a boundary point of T , z cannot be an interior point of S .
 b. Note that $T = f(S)$ is $\overline{D(0; 4)}$ so that f maps the boundary points: $\{z: |z| = 1, \operatorname{Re} z \geq 0\}$ and $\{iy: 1 < y < 2 \text{ or } -2 < y < -1\}$ into the interior of T .
4. Because $|f| = 1$ on $C(0; 1)$, by the Maximum Modulus Theorem $|f| \leq 1$ throughout $D(0; 1)$. Because $D(0; 1)$ is compact so is its image under the continuous function f . To show that f maps $D(0; 1)$ onto $D(0; 1)$, consider $f(0)$ and let T be the points on any chord of $C(0; 1)$ passing through $f(0)$. If T were not contained in the range of f , there would have to be some point $w \in T$, $|w| < 1$ which is a boundary point of the range of f . By the previous exercise, however, this is impossible.
5. Let $f(z)$ have zeroes at $\alpha_1, \dots, \alpha_N$. Then $g(z) = f(z)/(\prod_{i=1}^N \frac{z-\alpha_i}{1-\bar{\alpha}_i z})$ would have modulus 1 throughout the circle: $|z| = 1$, and $g(z) \neq 0$ at any points $z: |z| < 1$. Thus, both the maximum and modulus theorems can be applied to conclude that $|g| \equiv 1$ throughout $D(0; 1)$ and, hence, g is constant i.e., $f(z) = C \prod_{i=1}^N \frac{z-\alpha_i}{1-\bar{\alpha}_i z}$. Because f is entire, it follows that $\alpha_i = 0$ for all i and, thus, $f(z) = Cz^N$.
8. Note that $\frac{f(z)}{z^2}$ has modulus 1 throughout the boundary of the annulus and apply the Maximum Modulus Theorem.
9. Let $g(z) = \frac{1}{10} f(2z)$. Then $|g| < 1$ for $|z| < 1$ and $g(1/2) = 0$ so that $|g(z)| \leq \left| \frac{z-\frac{1}{2}}{1-\frac{1}{2}z} \right|$. In particular, $|g(1/4)| \leq 2/7$ and $|f(1/2)| \leq 20/7$.
10. Let $g(z) = \frac{f(z)-f(\alpha)}{1-f(\alpha)f(z)}$. Then g is also analytic and bounded by 1 in the unit disc and a direct calculation shows that $g'(\alpha) = \frac{f'(\alpha)}{1-|f(\alpha)|^2}$. Thus, $g'(\alpha) \gg f'(\alpha)$.
11. Because $f(\alpha) = 0$, $f'(\alpha) = \lim_{z \rightarrow \alpha} \frac{f(z)}{z-\alpha} \ll \lim_{z \rightarrow \alpha} \frac{B_\alpha(z)}{z-\alpha}$ (because $|f(z)| \leq |B_\alpha(z)|$ for all $|z| \leq 1 \Rightarrow f'(\alpha) \ll B'_\alpha(\alpha)$. [NOTE: $B'_\alpha(\alpha) = \frac{1}{1-|\alpha|^2}$].
12. Consider $g(z) = (z-iR)^2(z+iR)^2 f(z) = (z^2+R^2)^2 f(z)$. As in Proposition 7.3, it can be shown that $|g(z)| \leq 8R^2$ throughout $|z| = R$, and, hence, $|g(z)| = |(z^2+R^2)^2 f(z)| \leq 8R^2$ as long as $|z| < R$. Thus $|f(z)| \leq \left| \frac{8R^2}{(z^2+R^2)^2} \right|$, and letting $R \rightarrow \infty$, we conclude that $f \equiv 0$.
13. a. $\int_\Gamma f(z) dt = \int_\Gamma \int_0^1 \frac{\sin zt}{t} dt dz = \int_0^1 \int_\Gamma \frac{\sin zt}{t} dz dt = \int_0^1 0 dt = 0$.
 b. $f(z) = \int_0^1 \frac{\sin zt}{t} dt = \int_0^1 \left(z - \frac{z^3 t^2}{3!} + \frac{z^5 t^4}{5!} - \dots \right) dt = z - \frac{z^3}{3(3!)} + \frac{z^5}{5(5!)} - \dots$
14. a. $f(z) = \int_0^1 \frac{\sin zt}{t} dt = \int_0^1 \int_0^z \cos zt dz dt = \int_0^z \int_0^1 \cos zt dt dz$ so that $f'(z) = \int_0^1 \cos zt dt$.

b. According to (13b) $f'(z) = 1 - \frac{z^2}{3!} + \frac{z^4}{5!} - + \dots$ and

$$\begin{aligned} \int_0^1 \cos zt \, dt &= \int_0^1 \left(1 - \frac{z^2 t^2}{2!} + \frac{z^4 t^4}{4!} - + \dots \right) dt \\ &= 1 - \frac{z^2}{3(2!)} + \frac{z^4}{5(4!)} - + \dots = 1 - \frac{z^2}{3!} + \frac{z^4}{5!} - + \dots \end{aligned}$$

15. Note that g is a linear function of z with $g(0) = z_0$; $g(|z_1 - z_0|) = z_0 + e^{i\theta}|z_1 - z_0| = z_0 + (z_1 - z_0) = z_1$.
16. By the Schwarz Reflection Principle, f can be extended to the entire plane and would then be a bounded entire function. Hence, f is constant.
17. By the Schwarz Reflection Principle, if $f(z) = f(x+iy) = u(x+iy) + iv(x+iy)$, then $f(\bar{z}) = f(x-iy) = u(x-iy) + iv(x-iy) = u(x+iy) - iv(x+iy)$ and $f(-z) = f(-x-iy) = -u(x-iy) + iv(x-iy) = -u(x+iy) - iv(x+iy) = -f(z)$.
19. Note that g is differentiable for $|z| < 1$, and for $|z| > 1$ because $g'(z) = \overline{h'(\bar{z})}$ where $h(z) = f(1/z)$ for $|z| > 1$. Moreover, g is continuous on the upper semicircle so that g is analytic throughout the upper half-plane.
20. Arguing as in Exercise (19), such an analytic function could be extended to a bounded entire function.
21. If $f(x) = |x|$, by the Schwarz Reflection Principle, f can be extended to be analytic in the unit disc. However, $f'(0)$ cannot exist because $\lim_{h \rightarrow 0} \frac{f(h) - f(0)}{h}$ yields different values as $h \rightarrow 0$ along the positive real axis and along the negative real axis.

Chapter 8

1. γ represents the portion of the ray from α through z to ∞ , starting at z . Thus, if z is in the complement of S , so is all of γ . For, if any $z_1 \in \gamma$ belonged to S , so would the entire segment connecting α and z_1 , including z .
3. As suggested in the hint, let $C = \{z : |z - \alpha| = r\}$ and consider $\delta_z = \max\{t : D(z; t) \subseteq S\}$. δ_z is a continuous function of $z \in C$ and $\delta = \min_{z \in C} \delta_z$ exists. Hence, the annulus $B = \{z : r - \delta \leq |z - \alpha| \leq r + \delta\}$ is contained in S . It follows that any $z_0 \in D(\alpha; r)$ must belong to S . For any path γ connecting z_0 to ∞ must intersect C , and, at that point, $d(\gamma, \tilde{S}) \geq \delta$.
4. \tilde{S} is closed because it contains all its accumulation points. Moreover, any point $(x_0, \sin \frac{1}{x_0})$ can be connected by the curve $y = \sin \frac{1}{x}$ to $(\frac{1}{k\pi}, 0)$ which is within ϵ of $(0, 0)$ as long as $k > \frac{1}{\pi\epsilon}$. The positive y axis, contained in S , then, connects the origin to ∞ .
6. As in Lemma 8.3, we can view a simple closed curve Γ with k levels as a union of rectangles and one or more closed curves Γ' with $k - 1$ levels. We can then

define the inside of Γ as the points in the rectangles together with the inside of the closed curves Γ' . As in the proof of Lemma 8.3, it follows by induction that points inside Γ belong to any simply connected domain containing Γ .

7. Suppose $\gamma(t): a \leq t \leq b$ has $\gamma(t_2) = \gamma(t_1)$. Then γ can be written as a union of γ_1 and γ_2 where $\gamma_1 = \gamma(t); t \in [a, t_1] \cup [t_2, b]$ and $\gamma_2 = \gamma(t); t \in [t_1, t_2]$.
8. Note that, for points z on the negative axis, $\pi i + \int_{-1}^z \frac{d\zeta}{\zeta} = \pi i + \int_{-1}^{-|z|} \frac{d\zeta}{\zeta} = \pi i + \ln|z|$. Hence, $\text{Im}(\log z) = \pi i$ for all points on the negative axis. For any z , we can, then, choose the path of integration from -1 to $-|z|$, followed by the circular arc from $-|z|$ to z .

Chapter 9

1. Note that z_0 cannot be a removable singularity nor can it be an essential singularity.
2. No. According to Exercise 1, $|f(z)| \sim \exp\left(\frac{1}{|z|}\right) \Rightarrow f$ has a pole at $z = 0$, but then $|f(z)| \sim \frac{A}{|z|^k}$ near $z = 0$.
4. By Riemann's Principle, the singularity is removable; hence f is (can be considered) entire! But then $|f(z)| \leq A|z|$ for large z implies that f is a linear polynomial, and $|f(z)| \leq A\sqrt{|z|}$ for large z implies that f is constant.
6. $e^{1/z} \neq 0$. To solve $e^{(1/z)} = w$ for any $w \neq 0$, take $(1/z)$ equal to any of the infinitely many values of $\log w$. Note that infinitely many of these values for $1/z$ correspond to values of z in the unit disc.
7. $f + g$ will have a pole of order $\max(m, n)$ if $m \neq n$ and a (possible) pole of order $\leq m$ if $m = n$; $f \cdot g$ will have a pole of order $m + n$; f/g will have a pole of order $m - n$ if $m > n$, a zero of order $n - m$ if $n > m$, and a removable singularity if $m = n$.
9. a. Double pole at $z = 0$; simple pole at $\pm i$.
 b. Simple pole at $z = k\pi, k$ any integer.
 c. Same as (b).
 d. Essential singularity at $z = 0$; simple pole at $z = 1$.
11. a. $\sum_{k=-1}^{\infty} (-1)^{k+1} z^{2k}$
 b. $\sum_{k=-\infty}^{\infty} a_k z^k$ with

$$a_k = \begin{cases} -e & \text{if } k \geq 0, \\ -e + 1 + \frac{1}{1!} + \frac{1}{2!} + \cdots + \frac{1}{(j-1)!} & \text{if } k = -2j \text{ or } k = -2j + 1, \\ & j = 1, 2, \dots \end{cases}$$

c. $\sum_{k=-1}^{\infty} \frac{(-1)^{k+1} (z-2)^k}{4^{k+2}}$

14. Use $f(z) = \frac{f(z) - f(-z)}{2}$.
15. a. $\frac{1}{z^2} - \frac{1}{2i(z-i)} + \frac{1}{2i(z+i)}$

- b. $\frac{1}{2i(z-i)} - \frac{1}{2i(z+i)}$
16. If $|f(z) - w| > \delta$, $g(z) = \frac{1}{f(z)-w}$ would be analytic in D with zeroes at all the points of $\{z_n\}$ which would imply that g is identically zero.
17. a. Because the range of $\sin \frac{1}{z}$ is dense in the plane, so is the range of $\csc \frac{1}{z} = \frac{1}{\sin \frac{1}{z}}$
- b. Note that $\csc \frac{1}{z}$ has a pole at all the points $z = \frac{1}{k\pi}$, k an integer.
18. If f is a polynomial, according to the Fundamental Theorem of Algebra, the range of f is the full complex plane. Otherwise, note that $f(1/z)$ has an essential singularity at 0.

Chapter 10

1. a. $\frac{1}{z^4+z^2} = \frac{1}{z^2(z^2+1)} = \frac{1}{z^2}(1-z^2+z^4-\dots)$ around $z = 0$. Hence $\text{Res}\left(\frac{1}{z^4+z^2}; 0\right) = 0$; 0 is a double pole.
- $\frac{1}{z^4+z^2} = \frac{1}{z^2(z+i)(z-i)}$. Hence, $\frac{1}{z^4+z^2}$ has a simple pole at i , with $\text{Res} = \frac{i}{2}$, and a simple pole at $z = -i$, with $\text{Res} = \frac{-i}{2}$ (see Chapter 9, Exercise (15a)).
- b. $\cot z = \frac{\cos z}{\sin z}$ has a simple pole at every integral multiple of π with $\text{Res}(\cot z; \pi k) = 1$ for all k .
- c. $\csc z = \frac{1}{\sin z}$ has a simple pole at every integral multiple of π with $\text{Res}(\csc z; \pi k) = \frac{1}{\cos(\pi k)} = (-1)^k$.
- d. $\frac{\exp \frac{1}{z}}{z-1}$ has a simple pole at $z = 1$ with $\text{Res} = e$. Around $z = 0$,

$$\frac{e^{1/z^2}}{z-1} = \left(1 + \frac{1}{z^2} + \frac{1}{2!z^4} + \frac{1}{3!z^6} \dots\right) (-1 - z - z^2 \dots).$$

Hence, $\text{Res}\left(\frac{e^{1/z^2}}{z-1}; 0\right) = -e + 1$ (see Chapter 9, Exercise (11b); 0 is an essential singularity!).

- e. $\frac{1}{z^2+3z+2} = \frac{1}{(z+1)(z+2)}$. Hence $\frac{1}{z^2+3z+2}$ has simple poles at -1 and -2 with $\text{Res}\left(\frac{1}{z^2+3z+2}; -1\right) = 1$; $\text{Res}\left(\frac{1}{z^2+3z+2}; -2\right) = -1$.
- f. Essential singularity at $z = 0$ with $\text{Res} = 1$.
- g. Essential singularity at $z = 0$ with $\text{Res} = 9/2$.
- h. If $b^2 - 4ac \neq 0$, there are simple poles at $\frac{-b \pm \sqrt{b^2 - 4ac}}{2a}$ with residues of $\frac{1}{\pm \sqrt{b^2 - 4ac}}$. If $b^2 - 4ac = 0$, $\frac{1}{az^2+bz+c} = \frac{1}{a\left(z + \frac{b}{2a}\right)^2}$, so that there is a double pole at $z = \frac{-b}{2a}$ with residue zero.

2. a. $2\pi i$ (see (1b)).
 b.

$$2\pi i \sum_{k=1}^3 \frac{1}{(z_k - 4) \cdot 3z_k^2} = \frac{2\pi i}{3} \sum_{k=1}^3 \frac{z_k}{z_k - 4} \text{ where } z_k = e^{2k\pi i/3}, \quad k = 1, 2, 3,$$

$$= \frac{-2\pi i}{63}$$

- c. $2\pi i$ (see Exercise (1f)).
 d. $9\pi i$ (see Exercise (1g)).
 3. Let C be any regular closed curve surrounding $z = 0$ and *not* surrounding any of the other singularities: $z = 2\pi ki, k = \pm 1, \pm 2, \dots$. Then $\text{Res} \left(\frac{1}{(1-e^{-z})^n}; 0 \right) = \frac{1}{2\pi i} \int_C \frac{dz}{(1-e^{-z})^n}$. Letting

$$w = 1 - e^{-z},$$

$$e^{-z} = 1 - w$$

$$-e^{-z} dz = -dw$$

$$dz = \frac{dw}{e^{-z}} = \frac{dw}{1-w}$$

and

$$\frac{1}{2\pi i} \int_C \frac{dz}{(1-e^{-z})^n} = \frac{1}{2\pi i} \int_{C^*} \frac{dw}{w^n(1-w)}$$

where C^* is the image under $w = 1 - e^{-z}$ of C . [To see that C^* surrounds 0 and not 1 in the w -plane, we can consider C to be the boundary of the rectangle $-1 \leq x \leq 1; \frac{-\pi}{2} \leq y \leq \frac{\pi}{2}$ in which case C^* can be seen to be the left half of the annulus centered at 1 with inner radius $1/e$ and outer radius e .] Thus, $\text{Res} \left(\frac{1}{(1-e^{-z})^n}; 0 \right) = \text{Res} \left(\frac{1}{(w^n(1-w)); 0} \right) = 1$ because $\frac{1}{(w^n(1-w))} = \frac{1}{w^n} (1 + w + w^2 + \dots)$ has $\text{Res} = 1$ at $w = 0$ for all n .

6. $\frac{f(z+h)-f(z)}{h} = \int_{\gamma} \varphi(w) \left[\frac{\frac{1}{w-(z+h)} - \frac{1}{w-z}}{h} \right] dw$. Because $z \notin \gamma$, we can take $\lim_{h \rightarrow 0}$ inside the integral and $\lim_{h \rightarrow 0} \frac{f(z+h)-f(z)}{h} = \int_{\gamma} \frac{\varphi(w)}{(w-z)^2} dw$. In particular, because $f(z) = \frac{1}{2\pi i} \int_C \frac{f(w)}{w-z} dw$ where C is a regular curve surrounding z , it follows that $f'(z) = \frac{1}{2\pi i} \int_C \frac{f(w)}{(w-z)^2} dw$ and continuing inductively we can prove Theorem 10.11.

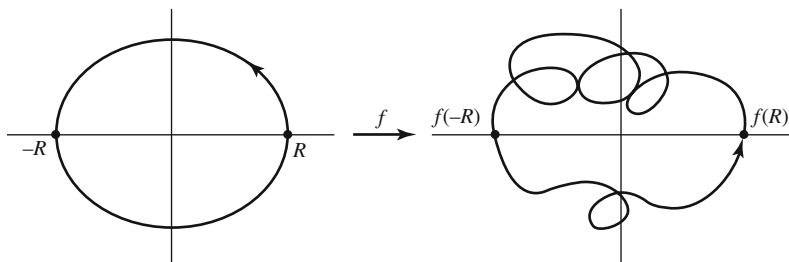

7. Consider the image of the circle $|z| = R$ under the mapping $w = f(z)$. Because $f(z)$ is real if, and only if, z is real, f maps the entire upper semicircle $|z| = R$; $y > 0$ into either the upper half-plane or the lower half-plane, and, likewise, f maps the entire lower semicircle $|z| = R$, $y < 0$ into either the upper or the lower half-plane. Because $\Delta \text{Arg } w$ is at most π in either the upper or lower half-plane, it follows that $\Delta \text{Arg } f(z)$, as z traverses $|z| = R$, is, at most, 2π and $\mathbb{Z}(f)$ in $|z| \leq R$, $= \frac{1}{2\pi} \Delta \text{Arg } f(z) \leq 1$.
9. a. 0 because $|3e^{-z}| \geq \frac{3}{e} > |z|$ on $|z| = 1$
 b. 1 because $|z| > \left| \frac{1}{3}e^z \right|$
 c. On $|z| = 2$, $|z^4| > |5z - 1|$. On $|z| = 1$, $|5z| > |z^4 + 1|$. Hence, there are 3 zeroes in the annulus.
 d. Note that, on $|z| = 1$, $|5z^4| = 5 \geq |z^6 + 3z^2 - 1|$ with equality possible only at $z = \pm i$. Because $z^6 - 5z^4 + 3z^2 - 1 \neq 0$ at $z = \pm i$, it follows that there are 4 zeroes in $|z| \leq 1$.
11. $\text{Res} \left(\frac{z^m f'(z)}{f(z)}; z_k \right) = p \cdot z_k^m$ where p is the order of the zero at z_k .
12. Note that $1 + z + \frac{z^2}{2!} + \cdots + \frac{z^n}{n!} \rightarrow e^z$ which has no zeroes anywhere. Because the convergence is *uniform* in $|z| \leq R$, the result follows.
14. Use the fact that $|a_n z^n| > |a_{n-1} z^{n-1} + \cdots + a_0|$ on the circle $|z| = R$ for sufficiently large R .
15. To show that $J(\lambda)$ is defined and continuous, note that $|f| > |g|$ throughout γ implies that $f + \lambda g$ is nonzero throughout γ for all $\lambda : 0 \leq \lambda \leq 1$.
16. Let $f(z) = \sqrt{z^2 - 1} = \exp \left(\frac{1}{2} \int_{\sqrt{2}}^z \frac{2\zeta d\zeta}{\zeta^2 - 1} \right)$. Without loss of generality, we can assume that the path of integration is in the upper half-plane, if $\text{Im } z > 0$, and in the lower half-plane, if $\text{Im } z < 0$. To show that $\lim_{z \rightarrow x} f(z)$ exists for $-\infty < x < -1$, we must establish that the same limit exists as we approach x through the upper half-plane or the lower half-plane. The difference between the limits equals $\int_C \frac{2\zeta}{\zeta^2 - 1} d\zeta$ where C is a regular closed curve surrounding $\zeta = \pm 1$. By the argument principle,

$$\int_C \frac{2\zeta}{\zeta^2 - 1} d\zeta = 2\pi i \sum \text{Res} \left(\frac{2\zeta}{\zeta^2 - 1}; \pm 1 \right) = 4\pi i$$

Hence, $\lim_{z \rightarrow x} \sqrt{z^2 - 1}$ exists because $e^{w/2} = e^{(w+4\pi i)/2}$. By Theorem 7.7, then f is analytic in the plane minus $[-1, 1]$.

17. Define $f(z) = \sqrt[3]{(z-1)(z-2)(z-3)}$ as $\exp\left(\frac{1}{3}\log[(z-1)(z-2)(z-3)]\right)$ where

$$\log[(z-1)(z-2)(z-3)] = \int_4^z \frac{[(z-1)(z-2)(z-3)]'}{(z-1)(z-2)(z-3)} dz + \log 6$$

for z in the plane minus the interval $(-\infty, 3]$. Show then that $f(z)$ defines a function which is continuous at all points x on the real axis with $x < 1$.

Chapter 11

1. a. $\int_{-\infty}^{\infty} \frac{x^2}{(1+x^2)^2} dx = 2\pi i \operatorname{Res}\left(\frac{z^2}{(z+i)^2(z-i)^2}; i\right) = 2\pi i f'(i)$ (where $f(z) = \frac{z^2}{(z+i)^2}$) $= \frac{\pi}{2}$.
- b. $\int_0^{\infty} \frac{x^2}{(x^2+4)^2(x^2+9)} dx = \frac{1}{2} \cdot 2\pi i \sum \operatorname{Res}\left(\frac{z^2}{(z^2+4)^2(z^2+9)}; 2i, 3i\right)$. Note that $\operatorname{Res}\left(\frac{z^2}{(z^2+4)^2(z^2+9)}; 3i\right) = \frac{(3i)^2}{((3i)^2+4)^2 6i} = \frac{3}{50}i$ and $\operatorname{Res}\left(\frac{z^2}{(z^2+4)^2(z^2+9)}; 2i\right) = f'(2i)$, with $f(z) = \frac{z^2}{(z+2i)^2(z^2+9)}$, and equals $-\frac{13}{200}i$. Thus, $\int_0^{\infty} \frac{x^2}{(x^2+4)^2(x^2+9)} dx = \pi i \left(-\frac{1}{200}i\right) = \frac{\pi}{200}$.
- c. Use the fact that $z^4 + z^2 + 1 = 0$ when $z^2 = -\frac{1}{2} \pm \frac{\sqrt{3}}{2}i$ or when $z^2 = e^{i\frac{2}{3}\pi}$ or $e^{i\frac{4}{3}\pi}$. Thus, $z^4 + z^2 + 1$ has zeroes in the upper half-plane at $z_1 = e^{i\pi/3}$ and at $z_2 = e^{i\frac{2}{3}\pi}$.

$$\operatorname{Res}\left(\frac{1}{z^4 + z^2 + 1}; z_1\right) = \frac{1}{4z^3 + 2z} \Big|_{z=e^{i\pi/3}} = \frac{1}{-3 + \sqrt{3}i},$$

$$\operatorname{Res}\left(\frac{1}{z^4 + z^2 + 1}; z_2\right) = \frac{1}{4z^3 + 2z} \Big|_{z=e^{i\frac{2}{3}\pi}} = \frac{1}{3 + \sqrt{3}i}$$

so that

$$\int_0^{\infty} \frac{dx}{x^4 + x^2 + 1} = \frac{1}{2} 2\pi i \left(\frac{1}{-3 + \sqrt{3}i} + \frac{1}{3 + \sqrt{3}i}\right) = \frac{\sqrt{3}\pi}{6}.$$

- d. $\int_0^{\infty} \frac{\sin x}{x(1+x^2)} dx = \frac{1}{2} \operatorname{Im} \int_{-\infty}^{\infty} \frac{e^{ix}-1}{x(1+x^2)} dx = \frac{1}{2} \operatorname{Im} \left(2\pi i \operatorname{Res}\left(\frac{e^{iz}-1}{z(1+z^2)}; i\right)\right) = \frac{1}{2} \operatorname{Im} \left(\frac{\pi(e-1)i}{e}\right) = \frac{\pi(e-1)}{2e}$.
- e. $\int_0^{\infty} \frac{\cos x}{1+x^2} dx = \frac{1}{2} \int_{-\infty}^{\infty} \frac{\cos x}{1+x^2} dx = \frac{1}{2} \operatorname{Re} \int_{-\infty}^{\infty} \frac{e^{ix}}{1+x^2} dx = \frac{1}{2} \cdot 2\pi i \operatorname{Res}\left(\frac{e^{iz}}{1+z^2}; i\right) = \pi/2e$.

f. $\int_0^\infty \frac{dx}{x^3+8} = -\sum_{k=1}^3 \operatorname{Res} \left(\frac{\log z}{z^3+8}; z_k \right)$ where $z_1 = 2e^{i\pi/3}$, $z_2 = 2e^{i\pi} = -2$; $z_3 = 2e^{i5\pi/3}$. Note then that $\operatorname{Res} \left(\frac{\log z}{z^3+8}; z_k \right) = \frac{-z_k \log z_k}{24}$ and $\sum_{k=1}^3 \operatorname{Res} \left(\frac{\log z}{z^3+8}; z_k \right) = -\frac{\sqrt{3}\pi}{18}$.

g. $(1 - e^{(\alpha-1)2\pi i}) \int_0^\infty \frac{x^{\alpha-1}}{1+x} dx = 2\pi i \operatorname{Res} \left(\frac{z^{\alpha-1}}{1+z}; -1 \right) = 2\pi i e^{(\alpha-1)\pi i}$. Since $e^{\pi i} = -1$; $e^{2\pi i} = 1$, $\int_0^\infty \frac{x^{\alpha-1}}{1+x} dx = \frac{-2\pi i e^{\alpha\pi i}}{1 - e^{2\alpha\pi i}} = \frac{-2\pi i}{e^{-\alpha\pi i} - e^{\alpha\pi i}} = \frac{\pi}{\sin(\pi\alpha)}$.

h.

$$\begin{aligned} \int_0^{2\pi} \frac{dx}{(2 + \cos x)^2} &= \frac{4}{i} \int_{|z|=1} \frac{z}{(z^2 + 4z + 1)^2} dz \\ &= 8\pi \operatorname{Res} \left(\frac{z}{(z^2 + 4z + 1)^2}; -2 + \sqrt{3} \right) \\ &= 8\pi f'(-2 + \sqrt{3}), \quad \text{with } f(z) = \frac{z}{(z + 2 + \sqrt{3})^2} \\ &= 8\pi \frac{\sqrt{3}}{18} = \frac{4}{9}\sqrt{3}\pi \end{aligned}$$

i.

$$\begin{aligned} \int_0^{2\pi} \frac{\sin^2 x}{5 + 3 \cos x} dx &= \frac{i}{2} \int_{|z|=1} \frac{(z^2 - 1)^2}{z^2(3z^2 + 10z + 3)} dz \\ &= -\pi \sum \operatorname{Res} \left(\frac{(z^2 - 1)^2}{z^2(3z^2 + 10z + 3)}; -\frac{1}{3}, 0 \right). \end{aligned}$$

The result follows by noting that the Res at $-1/3$ is $8/9$ and the Res at 0 , which equals $f'(0)$ with $f(z) = \frac{(z^2-1)^2}{3z^2+10z+3}$, is equal to $-\frac{10}{9}$.

j. $\int_0^{2\pi} \frac{dx}{a + \cos x} = \frac{2}{i} \int_{|z|=1} \frac{dz}{z^2 + 2az + 1} = 4\pi \operatorname{Res} \left(\frac{1}{z^2 + 2az + 1}; z_0 \right)$ where z_0 is the zero of $z^2 + 2az + 1$ with $|z_0| < 1$. Thus $z_0 = \begin{cases} -a + \sqrt{a^2 - 1} & \text{if } a > 1 \\ -a - \sqrt{a^2 - 1} & \text{if } a < -1 \end{cases}$

$$\int_0^{2\pi} \frac{dx}{a + \cos x} = \frac{4\pi}{2z_0 + 2a} = \frac{2\pi}{z_0 + a} = \begin{cases} 2\pi/\sqrt{a^2 - 1} & \text{if } a > 1 \\ -2\pi/\sqrt{a^2 - 1} & \text{if } a < -1 \end{cases}$$

2. Let C_R , Γ_R be as in 11.1 (I). $\int_{C_R} \frac{e^{2iz} - 1 - 2iz}{z^2} dz = 0$ because the integrand is entire.

Thus, $-2 \int_{-R}^R \frac{\sin^2 x}{x^2} dx - 2i \int_{\Gamma_R} \frac{dz}{z} + \int_{\Gamma_R} \frac{e^{2iz} - 1}{z^2} dz = 0$, and letting $R \rightarrow \infty$, we find $\int_{-\infty}^{\infty} \frac{\sin^2 x}{x^2} dx = \pi$.

3. Let C_n be the indicated contour; Γ_n the circular segment. Then, $\int_{C_n} \frac{1}{1+z^n} dz = 2\pi i \operatorname{Res} \left(\frac{1}{1+z^n}; e^{i\pi/n} \right) = \frac{-2\pi i}{n} e^{i\pi/n}$. Note that $\int_{\Gamma_n} \frac{dz}{1+z^n} \rightarrow 0$ as the radius of $\Gamma_n \rightarrow \infty$. Hence, letting $R \rightarrow \infty$, we find

$$\lim_{R \rightarrow \infty} \int_{C_n} \frac{1}{1+z^n} dz = \int_0^\infty \frac{1}{1+x^n} dx - e^{2\pi i/n} \int_0^\infty \frac{1}{1+x^n} dx,$$

and

$$(1 - e^{2\pi i/n}) \int_0^\infty \frac{1}{1+x^n} dx = -2\pi i e^{i\pi/n}.$$

Thus,

$$\int_0^\infty \frac{1}{1+x^n} dx = \frac{2\pi i e^{i\pi/n}}{e^{2\pi i/n} - 1} = \frac{2\pi i}{e^{\pi i/n} - e^{-\pi i/n}} = \frac{\pi/n}{\sin(\pi/n)}.$$

7. a. Note that on Γ_R , $|e^{iz^2}| = e^{-2xy}$ where $z = x + iy$. Because $x \geq \frac{R}{\sqrt{2}}$, $|e^{iz^2}| \leq e^{-Ry}$. Dividing Γ_R into the lower part $L = \{z \in \Gamma_R : y \leq h\}$ and an upper part $U = \{z \in \Gamma_R : y \geq h\}$, $\int_{\Gamma_R} e^{iz^2} dz = \int_L e^{iz^2} dz + \int_U e^{iz^2} dz \ll 2h + e^{-Rh} \left(\frac{\pi}{4}\right) R$ by the usual M - L formula. Choosing $h = \frac{1}{\sqrt{R}}$, e.g., we see that

$$\int_{\Gamma_R} e^{iz^2} dz \rightarrow 0 \text{ as } R \rightarrow \infty.$$

- b. $\int_{C_R} e^{iz^2} dz = 0$ where C_R is the boundary of the indicated sector. Parametrizing and letting $R \rightarrow \infty$, we see by (a) that $\int_0^\infty e^{ix^2} dx - e^{i\pi/4} \int_0^\infty e^{-x^2} dx = 0 \Rightarrow \int_0^\infty \cos x^2 dx + i \int_0^\infty \sin x^2 dx = e^{i\pi/4} \int_0^\infty e^{-x^2} dx$. Using the fact that $\int_0^\infty e^{-x^2} dx = \sqrt{\pi}/2$ and equating real and imaginary parts shows that $\int_0^\infty \cos x^2 dx = \int_0^\infty \sin x^2 dx = \frac{\sqrt{2\pi}}{4}$.
8. [Note that $\int_{|z|=R} \frac{P(z)}{Q(z)} dz = 2\pi i \sum_k \operatorname{Res} \left(\frac{P}{Q}; z_k \right)$ where $\{z_k\}$ represent the zeroes of Q in $|z| < R$ (assuming that $Q \neq 0$ on $|z| = R$.)] If we choose R large enough to encompass all the zeroes of Q , $\int_{|z|=R} \frac{P(z)}{Q(z)} dz = 2\pi i \sum \operatorname{Res} \left(\frac{P}{Q} \right)$. On the other hand, letting $R \rightarrow \infty$ and applying the usual $M - L$ estimates, $\int_{|z|=R} \frac{P(z)}{Q(z)} dz \rightarrow 0$. Hence, $\sum \operatorname{Res} \left(\frac{P}{Q} \right) = 0$.
9. a. $2 \sum_{n=1}^\infty \frac{1}{n^2+1} = -\sum_{k=1}^3 \operatorname{Res} \left(\frac{\pi \cot(\pi z)}{1+z^2}; z_k \right)$ where $z_1 = 0; z_2 = i; z_3 = -i = -\left(1 + \frac{\pi \cot(\pi i)}{i}\right) = -1 + \pi \left(\frac{e^{2\pi}+1}{e^{2\pi}-1}\right)$.
 $\sum_{n=1}^\infty \frac{1}{n^2+1} = -\frac{1}{2} + \frac{\pi}{2} \left(\frac{e^{2\pi}+1}{e^{2\pi}-1}\right)$.
- b. $\sum_{n=1}^\infty \frac{1}{n^4} = -\frac{1}{2} \operatorname{Res} \left(\frac{\pi \cot(\pi z)}{z^4}; 0 \right) = \frac{\pi^4}{90}$
- c. $1+2 \sum_{n=1}^\infty \frac{(-1)^n}{n^2+1} = -\sum_{z_k = \pm i} \operatorname{Res} \left(\frac{\pi}{(\sin \pi z)(z^2+1)}; z_k \right) = -\frac{\pi}{i \sin(\pi i)} = \frac{2\pi}{e^\pi - e^{-\pi}}$.
 $\sum_{n=1}^\infty \frac{(-1)^n}{n^2+1} = \frac{\pi e^\pi}{e^{2\pi}-1} - \frac{1}{2}$.

13. Because $\binom{3n}{n} = \frac{1}{2\pi i} \int_{|z|=R} \frac{(1+z)^{3n}}{z^{n+1}} dz$ for any $R > 0$, $\sum_{n=0}^{\infty} \binom{3n}{n} \frac{1}{8^n} = -\frac{8}{2\pi i} \times \int_{|z|=1/2} \frac{dz}{(z+1)^3 - 8z} = -\frac{8}{2\pi i} \int_{|z|=1/2} \frac{dz}{z^3 + 3z^2 - 5z + 1}$ (since $\left| \frac{(1+z)^3}{8z} \right| < \frac{27}{32}$ for $|z| = 1/2$). Because $z^3 + 3z^2 - 5z + 1 = (z-1)(z^2 + 4z - 1)$, the only zero of $z^3 + 3z^2 - 5z + 1$ inside $|z| = \frac{1}{2}$ is at $z = -2 + \sqrt{5}$, and $\sum_{n=0}^{\infty} \binom{2n}{n} \frac{1}{8^n} = -8 \operatorname{Res} \left(\frac{1}{z^3 + 3z^2 - 5z + 1}; -2 + \sqrt{5} \right) = \frac{5+3\sqrt{5}}{5}$.
14. Because $\binom{2n}{n} x^n = \frac{1}{2\pi i} \int_{|z|=R} \left(\frac{(1+z)^2 x}{z} \right)^n \frac{dz}{z}$ and because $\left| \frac{(1+z)^2 x}{z} \right| \leq |4x| < 1$ throughout $|z| = 1$, $\sum_{n=0}^{\infty} \binom{2n}{n} x^n = \frac{1}{2\pi i} \int_{|z|=1} \frac{-1}{(1+z)^2 x - z} dz$. Note that $(1+z)^2 x - z = xz^2 + (2x-1)z + x$ has zeroes at $(1-2x \pm \sqrt{1-4x})/2x$ and $(1-2x - \sqrt{1-4x})/2x$ is inside the unit circle. Thus, $\sum_{n=0}^{\infty} \binom{2n}{n} x^n = -\operatorname{Res} \left(-\frac{1}{(1+z)^2 x - z}; \frac{1-2x-\sqrt{1-4x}}{2x} \right) = \frac{1}{\sqrt{1-4x}}$.
15. Note that $\max_{a^2+b^2=4} a^2 b = \max_{0 \leq b \leq 2} (4b - b^3) = \frac{16}{9}\sqrt{3}$.
16. a. To maximize $\frac{a^2 b}{R^2}$ as in the diagram below, note that $(2R)^2 + 2^2 = 2(a^2 + b^2)$, so that $a^2 + b^2 = 2(R^2 + 1)$ and $\frac{a^2 b}{R^2} = \frac{b(6-b^2)}{2}$ because $R^2 = 2$. Hence, $\max \left| \frac{(z-1)^2(z+1)}{z^2} \right| = \frac{1}{2} \max(6b - b^3)$ occurs when $b = \sqrt{2}$ and $\max \left| \frac{(z-1)^2(z+1)}{z^2} \right| = 2\sqrt{2}$.

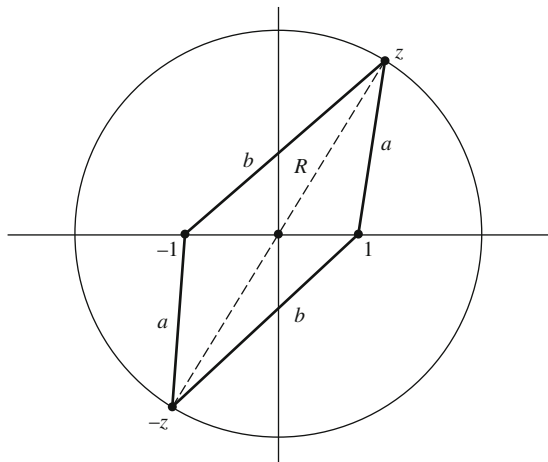

b. As in the diagram above

$$\max_{|z|=R} \left| \frac{(z-1)^2(z+1)}{z^2} \right| = \max \frac{a^2 b}{R^2} = \max \frac{b(2R^2 + 2 - b^2)}{R^2},$$

which occurs when $b^2 = \frac{1}{3}(2R^2 + 2)$, and is equal to $\frac{4\sqrt{6}(R^2+1)^{3/2}}{9R^2}$.
 But $\min_{0 < R < \infty} \frac{4\sqrt{6}(R^2+1)^{3/2}}{9R^2}$ occurs when $R = \sqrt{2}$ and equals $2\sqrt{2}$ as we saw in Exercise (16a).

Chapter 12

3. Note that $\int_{\Gamma_R} e^z \ln z dz = 0$ where Γ_R is the closed curve indicated below,

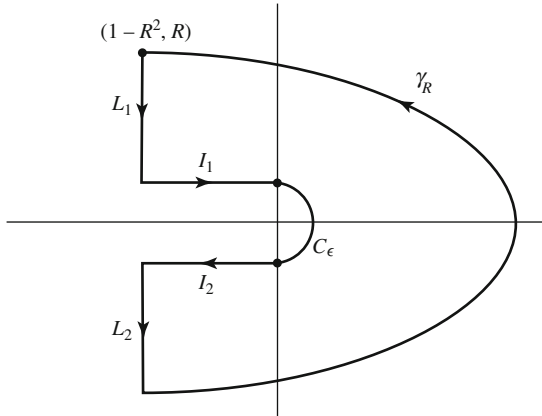

i.e., $\Gamma_R = \gamma_R \cup L_1 \cup I_1 \cup C_\epsilon \cup I_2 \cup L_2$. Because $|e^z \ln z| \leq e^{1-R^2} (\ln R + \pi)$ for $\text{Re } z = 1 - R^2$, $\int_{L_1 \cup L_2} e^z \ln z dz \rightarrow 0$ as $R \rightarrow \infty$. Similarly, $\int_{C_\epsilon} e^z \ln z dz \rightarrow 0$ as $\epsilon \rightarrow 0$. Hence $\int_{\gamma} e^z \ln z dz = \int_0^\infty e^{-x} (\ln x + \pi i) dx - \int_0^\infty e^{-x} (\ln x - \pi i) dx = 2\pi i$.

4.

$$\begin{aligned} \sum (-1)^k \binom{n}{k}^{1/3} &= \frac{1}{2\pi i} \int_C [f(z)]^{1/3} \frac{\pi}{\sin(\pi z)} dz \\ &\ll \frac{1}{\pi} \int_{-\frac{1}{2}-i\infty}^{-\frac{1}{2}+i\infty} \frac{\pi^{2/3}}{|\sin(\pi z)|^{2/3} \sqrt[3]{|z(1-z) \cdots (1-\frac{z}{n})|}} dz \\ &\ll \frac{A}{\sqrt[3]{\sqrt{n+1}}} = \frac{A}{(n+1)^{1/6}} \end{aligned}$$

5. a. On $\text{Re } z = -\frac{3}{4}$,

$$\frac{1}{\sqrt{|(1-z) \cdots (1-\frac{z}{n})|}} \leq \frac{1}{\sqrt{(1+\frac{3}{4})(1+\frac{3/4}{2}) \cdots (1+\frac{3/4}{n})}}$$

$$\begin{aligned}
 &= \frac{1}{\sqrt{\prod_{k=1}^n \left(1 + \frac{3}{4k}\right)}} \\
 &\leq \frac{1}{\sqrt{\left[\prod_{k=1}^n \left(1 + \frac{1}{k}\right)\right]^{3/4}}} \\
 &= \frac{1}{(n+1)^{3/8}}.
 \end{aligned}$$

Hence $\sum_{k=0}^n (-1)^k \sqrt{\binom{n}{k}} \ll \frac{A}{n^{3/8}}$.

- b. Let $\operatorname{Re} z = -1 + \delta = -t$. Then $|(1-z)\cdots(1-\frac{z}{n})| \geq \prod_{k=1}^n (1 + \frac{t}{k}) \geq \left[\prod_{k=1}^n \left(1 + \frac{1}{k}\right)\right]^t = (n+1)^{1-\delta}$. Also, because $|\sin(x+iy)| \geq |\sin x|$, $|\sin(\pi z)| \geq |\sin(\pi \delta)| \geq 2\delta$. Thus, $\left|\sum_{k=1}^n (-1)^k \sqrt{\binom{n}{k}}\right| \leq 2 \int_{-1+\delta-i\infty}^{-1+\delta+i\infty} \frac{dz}{\sqrt{\sin(\pi z)(1-z)\cdots(1-\frac{z}{n})}} \leq \frac{A}{\sqrt{\delta(n+1)^{1-\delta}}}$ and, taking $\delta = \frac{1}{\log n}$, $\left|\sum_{k=1}^n (-1)^k \sqrt{\binom{n}{k}}\right| \leq \frac{B\sqrt{\log n}}{\sqrt{n}}$.

Chapter 13

- Note that the solutions of $z^k = \alpha$ are uniformly distributed around the circle of radius $|\alpha|^{1/k}$. Hence z^k is 1-1 in any set of the form $S_{\alpha,\beta} = \{z : \alpha < \operatorname{Arg} z < \beta; \beta - \alpha < \frac{2\pi}{k}\}$.
- $x = x_0$ is mapped into a circle centered at 0 with radius e^{x_0} .
 $y = y_0$ is mapped into the ray re^{iy_0} ; $r > 0$.
- i. $f_3 \circ f_2 \circ f_1$ where $f_1(z) = \frac{\pi}{3}(z+2)$; $f_2(z) = e^{iz}$; $f_3(z) = \frac{z-i}{z+i}$.
ii. $f(z) = \frac{4z}{6-z}$ (see Theorem 13.23).
iii. $f(z) = \frac{4}{\pi} \log z$
iv. $f_3 \circ f_2 \circ f_1$ with $f_1(z) = \sqrt{z}$, $f_2(z) = -\frac{(z-1)^2}{4(z+1)^2}$ and $f_3(z) = \frac{z-i}{z+i}$.
- a. Note that lines are mapped into lines.
b. By considering $g(z) = \alpha f(\beta z + \gamma) + \delta$, we can assume without loss of generality that f maps a rectangle R of the form: $0 \leq x \leq a$, $0 \leq y \leq b$ onto a rectangle S of the form: $0 \leq x \leq c$, $0 \leq y \leq d$. If we assume, in addition that f maps the boundary curves of R onto the boundary curves of S , it will follow from the Schwarz Reflection Principle that $\operatorname{Re} f(z)$ and $\operatorname{Im} f(z)$ both grow (at most) linearly. Thus $|f(z)| \leq A|z| + B$ and, by the Extended Liouville Theorem, f is linear. See Example 2 in Section 7.2 and exercise 23 of Chapter 7. The fact that the boundary lines are, in fact, mapped onto the boundary lines, is proven in 14.9.

9. If $f_1(z) = \frac{a_1z+b_1}{c_1z+d_1}$, $f_2(z) = \frac{a_2z+b_2}{c_2z+d_2}$, then $f_2 \circ f_1(z) = \frac{Az+B}{Cz+D}$ with $A = a_2a_1 + b_2c_1$, $B = a_2b_1 + b_2d_1$, $C = a_1c_2 + c_1d_2$, $D = b_1c_2 + d_1d_2$ and $AD - BC = (a_1d_1 - b_1c_1)(a_2d_2 - b_2c_2)$. Also, as in the text, if $f(z) = \frac{az+b}{cz+d}$, $f^{-1}(z) = \frac{dz-b}{-cz+a}$. The other group properties are easily established.
10. a. $|z| = 1$.
 b. The line $x = -\frac{1}{2}$.
 c. $C(-\frac{2}{3}, \frac{1}{3})$. Note that $\frac{1}{z-2} = f_2 \circ f_1$ with $f_1(z) = z - 2$, $f_2(z) = \frac{1}{z}$ and use Lemma 13.10.
11. By Theorem 13.15, $f(z) = e^{i\theta}z$ and $e^{i\theta} = f'(0) > 0$.
12. Let $f(z) = f_1 \circ f_2^{-1}(z)$. Then $f(0) = 0$, and $f'(0) = f'_1(f_2^{-1}(0)) \cdot \frac{1}{f'_2(f_2^{-1}(0))} = \frac{f'_1(z_0)}{f'_2(z_0)} > 0$ so that, by Exercise 11, $f(z) \equiv z$ and $f_2 \equiv f_1$.
13. Use Theorems 13.15–13.17 and the fact that any disc or half-plane can be mapped onto the unit disc or upper half-plane, respectively, by a linear mapping.
14. The lower half-plane.
15. $\sqrt{\frac{az^2+b}{cz^2+d}}$; a, b, c, d real; $ad - bc > 0$.
16. Use the hint given with the exercise and the fact that $h_1 \circ h_2$ is of the form $\frac{az+b}{cz+d}$; a, b, c, d real as in the proof of Exercise 9.
17. (a) $i, -i$. (b) 0 .
18. $T(z) = \frac{(z-z_2)(z_3-z_1)}{(z-z_1)(z_3-z_2)}$ maps $z_1, z_2, z_3 \rightarrow \infty, 0, 1$, respectively, and because it is bilinear, it maps the circle (or line) containing z_1, z_2, z_3 onto the real line. Moreover, T is 1-1 so that $(z_1, z_2, z_3, z_4) = T(z_4)$ is real-valued if, and only if, z_4 lies on the circle (or line) containing z_1, z_2, z_3 .
19. (a) $w = -\frac{1}{z}$. (b) $w = z + i$. (c) $w = \frac{z-i}{z+i}$.
20. Note that $\frac{z-a}{1-\bar{a}z}$ maps $|z| < 1$ onto $|z| < 1$ and $g(z) = a \left(\frac{4z-1-\beta}{1-\beta(4z-1)} \right)$ maps $|z - \frac{1}{4}| < \frac{1}{4}$ onto $|z| < a$. Equating coefficients leads to $\alpha = 2 - \sqrt{3}$.

Chapter 14

1. Since g is locally irrotational and source-free, F is well defined and analytic. As z moves along a curve C from z_1 to z_2

$$\begin{aligned} F(z_2) - F(z_1) &= \int_{t_1}^{t_2} (u - iv)(dx + idy) \\ &= \int_{t_1}^{t_2} udx + vdy + i(udy - vdx) \end{aligned}$$

where $C: z(t)$; $z_k = z(t_k)$. If $\operatorname{Re} F(z)$ is constant throughout C , $\int_{t_1}^{t_2} u dx + v dy \equiv 0$, which implies that $g = u + iv$ is orthogonal to the (tangent) direction vector $\left(\frac{dx}{dt}, \frac{dy}{dt} \right)$.

2. Note that curves satisfying $\operatorname{Im} F(z) = \text{constant}$ are orthogonal to curves satisfying $\operatorname{Re} F(z) = \text{constant}$ since the two families of curves are the preimages under F of the orthogonal curves: $x = \text{constant}$ and $y = \text{constant}$. Alternatively, argue as in Exercise 1, that $\int_C u dy - v dx = 0$ implies that the vector (u, v) is orthogonal to the direction $\left(\frac{dy}{dt}, -\frac{dx}{dt}\right)$.
3. a. The hyperbolas $xy = c$.
b. Rays from the origin.
4. Note that, if $F(z) = z + A_0 + \frac{A_1}{z} + \frac{A_2}{z^2} + \cdots$, with $A_k = a_k + ib_k$; a_k, b_k real, then $\operatorname{Im} F(e^{i\theta}) = \sin \theta + b_0 - \sum_{k=1}^{\infty} a_k \sin(k\theta) + \sum_{k=1}^{\infty} b_k \cos(k\theta)$. Hence, by the uniqueness of the Fourier series, $a_1 = 1$; $a_k = 0$ for $k > 1$ and $b_k = 0$ for $k \geq 1$, i.e., $F(z) = z + A_0 + \frac{1}{z}$.
5. a. For $f(z) = 2z + \frac{1}{z}$, $f(e^{i\theta}) = 3 \cos \theta + i \sin \theta = u + iv$ with $\frac{u^2}{9} + v^2 = 1$.
b. Take $f(z) = f_2 \circ f_1$ where f_1 is the inverse of $2z + \frac{1}{z}$, i.e., $f_1(z) = \frac{z + \sqrt{z^2 - 8}}{4}$ and $f_2(z) = z + \frac{1}{z}$.
6. Let $g(z) = e^{i\theta} \left[\frac{f(z) - f(z_0)}{1 - \overline{f(z_0)}f(z)} \right]$. Because $g'(z_0) = \frac{e^{i\theta} f'(z_0)}{1 - |f(z_0)|^2}$, choose $\theta = -\operatorname{Arg} f'(z_0)$.
9. If $R \neq \mathbb{C}$, let $f_1 : R \rightarrow U$ and $f_2 : R \rightarrow U$ be such that $f_1(z_1) = f_2(z_2) = 0$. Then, $f = f_2^{-1} \circ f_1$ is the desired mapping. If $R = \mathbb{C}$, let $f(z) = z - z_1 + z_2$.
10. If $f_1 : \mathbb{C} \rightarrow R$ were conformal, then $f = f_2 \circ f_1$, where $f_2 : R \rightarrow U$ would be a conformal mapping of \mathbb{C} onto U which is impossible by Liouville's Theorem.
11. a. Note, as in the proof of the Riemann Mapping Theorem, part B, that $|g'(z_0)| < \frac{1}{\delta}$ where δ is such that $\bar{D}(z_0; \delta) \subset R$.
b. Let $\varphi_1(z)$ be the Riemann mapping function $\varphi_1 : R \rightarrow U$ with $\varphi_1(z_0) = 0$, $\varphi_1'(z_0) = M > 0$ and let $\varphi_2 : R \rightarrow U$ with $\varphi_2(z_0) = 0$, $\varphi_2'(z_0) = M^* \geq M$. Let $f(z) = \varphi_2 \circ \varphi_1^{-1}(z)$. Then f is analytic in the unit disc; $|f| < 1$ there, $f(0) = 0$ and $f'(0) = \frac{\varphi_2'(z_0)}{\varphi_1'(z_0)} = \frac{M^*}{M} \geq 1$. Hence, by Schwarz' lemma, $M^* = M$ and $f(z) = z$, i.e., $\varphi_2 = \varphi_1$.

Chapter 15

2. $e^{\epsilon iz^2}$
3. e^z maps the lines $y = \pm \frac{\pi}{2}$ onto the imaginary axis; hence, $e^{e^z} \ll 1$ on the boundary of D . If $f(z) \ll A_\epsilon e^{\epsilon e^z}$ in D , then $g(z) = f(\log z) \ll A_\epsilon e^{\epsilon |z|}$ in the right half-plane.

Chapter 16

1. $u + v = \operatorname{Re}[(1 - i)f]$; $uv = \operatorname{Re}\left(\frac{-if^2}{2}\right)$.
2. If $g = f_x$, then $g_{xx} + g_{yy} = (f_{xx} + f_{yy})_x = 0$. Similarly, f_y is harmonic.
3. If $g = u^2$, $g_{xx} + g_{yy} = 2u(u_{xx} + u_{yy}) + 2(u_x^2 + u_y^2) = 2(u_x^2 + u_y^2)$ which cannot be identically zero unless u is constant.
4. A direct calculation shows that, if $u = \log(x^2 + y^2)$, $u_{xx} + u_{yy} = 0$. If u were the real part of an analytic $f(z)$, $z \neq 0$, f would have to agree up to an additive constant with the analytic function $\log z$ in the simply connected domain $0 < \operatorname{Arg} z < 2\pi$. But then, $f(z)$, like $\log z$, would not be continuous on the positive real axis.
5. Note that, if $v(r, \theta) = u(r \cos \theta, r \sin \theta)$, then, $r^2 v_{rr} + r v_r + v_{\theta\theta} = r^2(u_{xx} + u_{yy})$. Hence, Laplace's equation becomes

$$r^2 v_{rr} + r v_r + v_{\theta\theta} = 0 \text{ or } r \frac{\partial}{\partial r}(r v_r) + v_{\theta\theta} = 0.$$

i.e., $\frac{\partial}{\partial r}(r v_r) + \frac{1}{r} v_{\theta\theta} = 0$. If v depends on r alone, $v_{\theta\theta} = 0$, and the above differential equation implies

$$v = a \ln r + b.$$

Note also that, if $v_r = 0$ and v is harmonic, then $v_{\theta\theta} = 0$, or $v(\theta) = a\theta + b$.

6. $2\pi i f(z) = \int_{C_R} \frac{f(\zeta)}{\zeta - z} d\zeta - \int_{C_R} \frac{f(\zeta)}{\zeta - z} d\zeta = \int_{C_R} \frac{(z - \bar{z})f(\zeta)}{(\zeta - z)(\bar{\zeta} - \bar{z})} d\zeta$. Let Γ_R be the semi-circular arc $|z| = R$, $\operatorname{Im} z \geq 0$. Then, as $R \rightarrow \infty$, $\int_{\Gamma_R} \frac{(z - \bar{z})f(\zeta)}{(\zeta - z)(\bar{\zeta} - \bar{z})} d\zeta \rightarrow 0$ by the M - L formula, so that

$$2\pi i f(z) = 2i \int_{-\infty}^{\infty} \frac{y f(t)}{(t - x)^2 + y^2} dt,$$

and, dividing by $2\pi i$ and equating real parts,

$$u(x + iy) = \frac{1}{\pi} \int_{-\infty}^{\infty} \frac{y u(t)}{(t - x)^2 + y^2} dt$$

7. Note that $\operatorname{Re}(z^3) = x^3 - 3xy^2 = 4x^3 - 3x$ on the unit circle. Hence

$$u(x, y) = \frac{1}{4}(x^3 - 3xy^2 + 3x).$$

8. $u(z) = \frac{3}{2} - \frac{1}{\pi} \operatorname{Arg}\left(\frac{z-1}{z+1}\right)$ where the Arg takes values between $\frac{\pi}{2}$ and $\frac{3\pi}{2}$.

$$u(z) = k \Rightarrow \operatorname{Arg}\left(\frac{z-1}{z+1}\right) = \theta = \pi\left(\frac{3}{2} - k\right).$$

Thus, for $\frac{1}{2} < k < 1$, z lies on the upper arc of a circle for which $[-1, 1]$ is a chord and for which the lower arc has 2θ degrees. For $0 < k < \frac{1}{2}$, z lies on congruent arcs in the lower half-plane. The chord $[-1, 1]$ is the level curve for $k = \frac{1}{2}$.

9. $\frac{1}{\pi} \operatorname{Arg} z = \frac{1}{\pi} \theta$ (see the note following Exercise 5).
 10. $\sin z$ maps the strip onto the upper half-plane with the boundary of the strip being mapped onto the real line segments $(-\infty, -1)$, $[-1, 1]$, $(1, \infty)$.

In the upper half-plane: $w > 0$, $\operatorname{Arg}(w^2 - 1)$ has the values 2π , π , 0 on the intervals $(-\infty, -1)$, $(-1, 1)$ and $(1, \infty)$, respectively, and $\operatorname{Arg}(w^2 - 1) = \operatorname{Im}[\log(w^2 - 1)]$ is the imaginary part of a function analytic in the upper half-plane. Thus, the desired solution is

$$u(x, y) = \frac{1}{\pi} \operatorname{Arg}(\sin^2 z - 1) = \frac{1}{\pi} \operatorname{Arg}(-\cos^2 z)$$

Note, for example, that on the y axis, $u(0, y) = \frac{1}{\pi} \operatorname{Arg}(-\cosh^2 y) = 1$.

11. By Theorem 16.3, if $e^z - P(z)$ does not have infinitely many zeroes,

$$e^z - P(z) = Q(z)e^{R(z)}$$

where Q , R are polynomials. Considering the growth at infinity, it follows that $R(z) = z$, $Q(z) = 1$, and $P(z) = 0$. Similarly, for $\sin z - P(z)$.

12. If a function f of order j does not have infinitely many zeroes,

$$f(z) = Q(z)e^{P(z)}.$$

But if $f \neq 0$, Q is a constant and f can be written in the form $f(z) = e^{P(z)}$. Finally, because f is of order j , P is a polynomial of degree j .

Chapter 17

1. $\prod_{k=2}^N \left(1 - \frac{1}{k^2}\right) = \prod_{k=2}^N \frac{(k-1)(k+1)}{k^2} = \frac{N+1}{2N}$. Hence $P_N \rightarrow \frac{1}{2}$ as $N \rightarrow \infty$.
 2. $\prod_{k=2}^N \left[1 + \frac{(-1)^k}{k}\right] = \left(\frac{3}{2}\right) \left(\frac{2}{3}\right) \left(\frac{5}{4}\right) \left(\frac{4}{5}\right) \cdots \left[1 + \frac{(-1)^N}{N}\right]$. Hence,

$$P_N = \begin{cases} 1 & \text{if } N \text{ is odd} \\ 1 + \frac{1}{N} & \text{if } N \text{ is even} \end{cases}$$

and $P_N \rightarrow 1$ as $N \rightarrow \infty$.

4. $\log(1 + z_k) - z_k = -\frac{z_k^2}{2} + \frac{z_k^3}{3} - \cdots \ll z_k^2$ if $|z_k| \leq \frac{1}{2}$. Hence, if $\sum |z_k|^2$ converges, so does $\sum [\log(1 + z_k) - z_k]$ and, because $\sum z_k$ converges, it follows that $\sum \log(1 + z_k)$ converges. By Proposition 17.2, then, $\prod(1 + z_k)$ converges.

5. Because $\sum z_k = \sum \frac{(-1)^k}{\sqrt{k}}$ converges, the convergence of $\sum \log(1 + z_k)$ is equivalent to the convergence of $\sum [\log(1 + z_k) - z_k]$. But the latter is $\sum_k \left(-\frac{z_k^2}{2} + \frac{z_k^3}{3} - \dots \right)$ and, for $k \geq 4$, $\log(1 + z_k) - z_k \leq \frac{-1}{6k}$ so that $\sum \log(1 + z_k)$ diverges.
6. $(1 + z)(1 + z^2) \cdots (1 + z^{2^{N-1}}) = 1 + z + z^2 + \cdots + z^{2^N - 1} \rightarrow \sum_{k=0}^{\infty} z^k = \frac{1}{1-z}$ uniformly for $|z| \leq r < 1$.

7. $\prod_{k=1}^{\infty} \left(1 - \frac{z}{k^2} \right)$

8. Using the power series expansion for $\sin z$, it can be seen that $\frac{\sin \pi \sqrt{z}}{\pi \sqrt{z}}$ is entire and equal to zero if $z = k^2$; $k = 1, 2, \dots$. Note, also, that, according to Proposition 17.8, the solutions in (7) and (8) are identical.

9. $f(z) = \prod_{k=1}^{\infty} \left(1 - \frac{4z^2}{(2k+1)^2} \right) / \cos \pi z$ is entire and zero-free. As in Proposition 17.8, it can be shown (considering the magnitude of f on a square of side $2N$ centered at the origin) that $|f(z)| \leq A \exp(|z|^{3/2})$ and that f is, in fact, constant, so that $f(z) = f(0) = 1$. The product form also be derived from the identity:

$$\cos \pi z = \frac{\sin 2\pi z}{2 \sin \pi z}.$$

10. a. $\prod_{k=1}^{\infty} \left[1 - \frac{1}{k(1-z)} \right] \exp \left(\frac{1}{k(1-z)} \right)$.

- b. Let $\{z_k\}$ be a sequence of distinct points with $\lim_{k \rightarrow \infty} z_k = z_0$. Then, an entire function can be defined with zeroes at the points $\lambda_k = \frac{1}{z_0 - z_k}$. Setting $g(z) = f \left(\frac{1}{z_0 - z} \right)$, g will be analytic for $z \neq z_0$ and equal to zero at the points of the original sequence $\{z_k\}$.

11. $F'(z) = \frac{1}{2\pi i} \int_C \int_a^b \frac{\varphi(\zeta, t)}{(\zeta - z)^2} dt d\zeta = \int_a^b \frac{1}{2\pi i} \int_C \frac{\varphi(\zeta, t)}{(\zeta - z)^2} d\zeta dt = \int_a^b \frac{\partial}{\partial z} (\varphi(z, t)) dt$.

12. Because h is continuous, $|h| \leq M$ on $[\alpha, \beta]$. For any $\epsilon > 0$, $\int_a^{x-\epsilon} \frac{h(u)y}{(u-x)^2 + y^2} du$ and $\int_{x+\epsilon}^{\beta} \frac{h(u)y}{(u-x)^2 + y^2} du$ are each bounded in absolute value by $\frac{My(\beta-\alpha)}{\epsilon^2}$ whereas $\int_{x-\epsilon}^{x+\epsilon} \frac{h(u)y}{(u-x)^2 + y^2} du = h(\bar{x}) \cdot 2 \tan^{-1} \left(\frac{\epsilon}{y} \right)$ where $x - \epsilon < \bar{x} < x + \epsilon$. Hence, as $y \rightarrow 0$, $\int_a^{\beta} \frac{h(u)y}{(u-x)^2 + y^2} du$ can be made arbitrarily close to $\pi h(x)$.

13. $f(z) = \int_0^1 \frac{dt}{1-zt} = -\frac{\log(1-z)}{z}$ which is analytic in $\mathbb{C} - [1, \infty)$. By the argument principle, $\Delta \text{Arg}(1 - z) = 2\pi i$ as z circles the point $z = 1$; hence, f has a jump discontinuity of $\frac{2\pi i}{x}$ as z crosses from the upper half-plane to the lower half-plane at $z = x > 1$. Note also that, if we consider $g(z) = \int_0^{\infty} \frac{dt}{e^t - z}$ (Example 2 following 17.9), setting $u = e^{-t}$, it can be shown that $g(z) = \int_0^1 \frac{dt}{1-zt}$.

Chapter 18

- Assuming $\log z$ is the principle branch, i.e., $\text{Im } \log z = 0$ on the positive axis, it follows that $\text{Im } g_1(z)$ will be between $-\pi$ and $-\frac{\pi}{2}$ in the third quadrant, whereas $\text{Im } g_2(z)$ will be between π and $\frac{3\pi}{2}$.
- Note that $f(-z) = \sum a_n z^n$; $a_n \geq 0$, and apply Theorem 18.3.
- a. Because $\frac{1}{n^{1/3}} = \frac{1}{\Gamma(1/3)} \int_0^\infty e^{-nt} t^{-2/3} dt$,

$$\begin{aligned} \sum \frac{z^n}{n^{1/3}} &= \frac{1}{\Gamma(1/3)} \int_0^\infty \sum (ze^{-t})^n t^{-2/3} dt \\ &= \frac{1}{\Gamma(1/3)} \int_0^\infty \frac{z}{t^{2/3}(e^t - z)} dt \end{aligned}$$

which is analytic outside of the interval $[1, \infty)$

- Since $\frac{1}{n^2+1} = \int_0^\infty e^{-nt} \sin t dt$,

$$\begin{aligned} \sum \frac{z^n}{n^2+1} &= \sum \int_0^\infty (ze^{-t})^n \sin t dt \\ &= \int_0^\infty \sum (ze^{-t})^n \sin t dt = \int_0^\infty \frac{e^t \sin t}{e^t - z} dt \end{aligned}$$

which is analytic outside of the interval $[1, \infty)$

- Make the change-of-variables $u = nt$.
- Setting $u = t^2$ yields

$$\int_0^\infty e^{-t^2} dt = \frac{1}{2} \Gamma\left(\frac{1}{2}\right) = \frac{\sqrt{\pi}}{2}.$$

- Because $e^{-t/n} = 1 - \frac{t}{n} + \frac{t^2}{2n^2} - + \dots$, $0 \leq e^{-t/n} - (1 - \frac{t}{n}) \leq \frac{t^2}{2n^2}$, if $t \leq n$, so that $e^{-t} - (1 - \frac{t}{n})^n \leq e \cdot \frac{e^{-t} t^2}{2n}$ and

$$\begin{aligned} \int_0^n t^{z-1} \left(1 - \frac{t}{n}\right)^n dt - \int_0^n t^{z-1} e^{-t} dt &\ll \frac{e}{2n} \int_0^n t^{z-1} e^{-t} t^2 dt \\ &\leq \frac{e}{2n} \Gamma(\text{Re } z + 2) \end{aligned}$$

which approaches 0 as $n \rightarrow \infty$.

- $f(z) = 1 - \frac{1}{2^z} + \frac{1}{3^z} - + \dots = \left(1 - \frac{2}{2^z}\right) \zeta(z)$ so that f is certainly analytic, like $\zeta(z)$, for $z \neq 1$. Moreover, $\lim_{z \rightarrow 1} f(z) = \lim_{z \rightarrow 1} \frac{2^z - 2}{2^z(z-1)} = \ln 2$ so that f is analytic at $z = 1$ as well.
- Because $\zeta(z) \rightarrow \infty$ as $z \rightarrow 1$, $\Pi\left(1 - \frac{1}{p}\right)$ diverges to 0. Because $\sum \frac{1}{p^2}$ converges, this implies that $\sum \frac{1}{p}$ diverges (see Chapter 17, Exercise 4).

Chapter 19

1. Consider $f(z) = \tan z - z$ inside the square centered at the origin and with sides of length $2\pi N$, whose boundary is denoted C_N . Then, the number of poles of $f(z)$ inside $C_N =$ the number of zeros of $\cos z$ inside $C_N = 2N$. The number of *real* zeros of f inside C_N is $2N + 1$ since f has a triple zero at the origin and $\tan x = x$ has exactly one solution in each of the intervals $[(2k - 1)\frac{\pi}{2}, (2k + 1)\frac{\pi}{2}]$; $k = \pm 1, \pm 2, \dots, \pm(N - 1)$.

Let $c =$ the number of complex, *nonreal* zeros of $\tan z - z$ inside C_N . Then

$$\frac{1}{2\pi i} \int_{C_N} \frac{\tan^2 z}{\tan z - z} dz = \mathbb{Z} - \mathbb{P} = 1 + c$$

by the calculations above.

By the usual $M - L$ estimates and the fact that $|\tan z| < 1 + \epsilon$ throughout C_N (where $\epsilon \rightarrow 0$ as $N \rightarrow \infty$), it follows that

$$\mathbb{Z} - \mathbb{P} = 1 + c < 2.$$

Hence $c = 0$.

2. With $f_2(z) = \frac{z^2}{(1+z^2)(\tan z - z)}$, note that $\int_{C_N} f_2(z) dz \rightarrow -2\pi i$ whereas

$$\int_{C_N} f_2(z) dz \rightarrow 2\pi i \left[\sum_{\substack{k=1 \\ x_k \neq 0}}^{\infty} \frac{\sin^2 x_k}{x_k^2} + \text{Res}(f_2; i) + \text{Res}(f_2; -i) + \text{Res}(f_2; 0) \right].$$

Note, then, that $\text{Res}(f_2; i) = \text{Res}(f_2; -i) = -\left(\frac{e^2+1}{4}\right)$ whereas $\text{Res}(f_2; 0) = 3$ because $\frac{z^2}{\tan z - z}$ has a simple pole at $z = 0$ and $\lim_{z \rightarrow 0} \frac{z^3}{\tan z - z} = 3$. Hence, $\sum_{\substack{k=0 \\ x_k \neq 0}}^{\infty} \frac{\sin^2 x_k}{x_k^2} = \frac{e^2-7}{2}$ and $\text{Var} \left(\frac{\sin^2 x}{x} \right) = 2 \sum_{\substack{k=1 \\ x_k \neq 0}}^{\infty} \frac{\sin^2 x_k}{x_k^2} + 2 = e^2 - 5$.

3. Let $f(z) = \frac{e^z - 1}{z^2(e^z - z)}$. Then $\int_{C_N} f(z) dz \rightarrow 0$ as $N \rightarrow \infty$ if C_N is a square centered at the origin with sides of length $2\pi N$. At the same time, $\int_{C_N} f(z) dz \rightarrow 2\pi i \left(\sum \frac{1}{z_k} + \text{Res}(f; 0) \right)$ where the sum is taken over the zeros of $e^z - z$. Because $\text{Res}(f; 0) = +1$ it follows that $\sum \frac{1}{z_k} = -1$.
4. As in Section 19.3, a solution $\{a_k\}, \{b_k\}$, would imply

$$1 + a_1 z + \frac{a_2 z^2}{2!} + \dots = e^{az} = 1 + az + \frac{a^2 z^2}{2!} + \dots$$

$$1 + b_1 z + \frac{b_2 z^2}{2!} + \dots = e^{\beta z} = 1 + \beta z + \frac{\beta^2 z^2}{2!} + \dots$$

so that $\alpha = a_1$ and $a_k = a_1^k$, $k = 2, 3, \dots$, and $\beta = b_1$, $b_k = b_1^k$; $k = 2, 3, \dots$. Thus, there would be infinitely many solutions of the form $\{a_k\}$, $\{b_k\}$ with $a_1, b_1 \geq 0$; $a_1 + b_1 = 2$ and $a_k = a_1^k$; $b_k = b_1^k$ for $k = 2, 3, \dots$.

5. Suppose d_1 is relatively prime to all d_j , $j \neq 1$, and assume that the desired partition is possible. Then, as in Section 19.5,

$$\frac{z}{1-z} = \frac{z^{a_1}}{1-z^{d_1}} + \frac{z_2^a}{1-z^{d_2}} + \cdots + \frac{z^{a_k}}{1-z^{d_k}}$$

for $|z| < 1$. Then, if we let $z \rightarrow e^{2\pi i/d_1}$, the first term on the right side of the equality would approach infinity whereas all the others would approach a finite limit. Thus, the partition is impossible. (In fact, according to this argument, the partition would be impossible as long as one of the differences is not a divisor of any of the others.)

9. $\sum_{n=2}^{\infty} \left| \frac{1}{np^{nz}} \right| = \sum_{n=2}^{\infty} \frac{1}{np^{nx}} \leq \frac{1}{2} \sum_{n=2}^{\infty} \frac{1}{p^{nx}} = \frac{1}{2p^{2x}} \frac{p^x}{(p^x-1)} \leq \frac{2}{p^{2x}}$ for $x > \frac{1}{2}$.

In fact, for $x \geq \frac{1}{2} + \delta$, $\sum_{n=2}^{\infty} \left| \frac{1}{np^{nz}} \right| \leq \sum_{p \text{ prime}} \frac{2}{p^{1+2\delta}} \leq \sum_{n=1}^{\infty} \frac{2}{n^{1+2\delta}} < \infty$.

Thus, $\sum_{p \text{ prime}} \frac{1}{np^{nz}}$ is uniformly convergent on compacta and is analytic in the half-plane $\text{Re } z > \frac{1}{2}$.

References

1. Ahlfors, L. *Complex Analysis*, third edition, McGraw-Hill, NY, 1979
2. Apostol, T. *Introduction to Analytic Number Theory*, Springer-Verlag, NY, 1976
3. Bak, J., Ding, P. and Newman, D.J. *Extremal Points, Critical Points, and Saddle Points of Analytic Functions*, American Mathematical Monthly **114** (2007), 540–546
4. Bak, J. and Ding, P. *Shape Distortion by Analytic Functions*, American Mathematical Monthly **116** (2009), 143–150
5. Conway, J. *Functions of One Complex Variable*, 2nd edition, Springer-Verlag, 1978
6. Carathéodory, C. *Theory of Functions of a Complex Variable*, Chelsea Publishing Company, NY, 1954
7. Davis, P. *The Schwarz Function and Its Applications*, The Mathematical Association of America, 1974
8. Henrici, P. *Applied and Computational Complex Analysis*, Wiley, 1986
9. Lang, S. *Complex Analysis*, 2nd edition, Springer-Verlag, NY 1985
10. Markushevich, A.I. *Theory of Functions of a Complex Variable*, (English Edition) Prentice-Hall, Englewood Cliffs, NJ, 1965.
11. Milne-Thomson, L.M. *Theoretical Hydrodynamics*, Macmillan, NY, 1968
12. Nahin, P. *An Imaginary Tale: The Story of $\sqrt{-1}$* , Princeton University Press, Princeton, NJ 1998
13. Needham, T. *Visual Complex Analysis*, Oxford University Press, 1997
14. Nehari, Z. *Conformal Mapping*, McGraw-Hill, 1952
15. Newman, M.H.A. *Elements of the Topology of Plane Sets of Points*, Cambridge University Press, 1964
16. Newman, D.J. *Simple Analytic Proof of the Prime Number Theorem*, American Mathematical Monthly 87 (1980), pp. 693–696
17. Pólya G. and G. Szegő, G. *Problems and Theorems in Analysis I*, Springer-Verlag, 1972
18. Stillwell, J.C. *Mathematics and Its History*, Springer-Verlag, 1989
19. Titchmarsh, E.C. *The Theory of Functions*, 2nd edition, Oxford University Press, London, 1939.
20. Wilf, H. *Generatingfunctionology*, Academic Press, 1994
21. Zagier, D. *Newman's Short Proof of the Prime Number Theorem*, American Mathematical Monthly 104 (1993), 705–708.
22. Zalcman, L. *Picard's Theorem without Tears*, American Mathematical Monthly, **85** (1978), 265–268

Appendices

I A Note on Simply Connected Regions

The definition of simple connectedness (8.1) led to a relatively easy proof of the General Closed Curve Theorem (8.6). At the same time, while Definition 8.1 was somewhat complicated, we were able to establish the very intuitive result that a simply connected region contains, along with any closed polygonal path, all of the points which are “inside” the path. (See Lemma 8.3 and Exercise 6 of Chapter 8). This property of a simply connected region can be generalized. That is, a simply connected region contains, along with *any* closed curve, all the points inside the curve. The difficulty in proving the general result lies in defining the “inside” of a general closed curve. If we limit ourselves to smooth closed curves, however, we can use complex integrals to define the “inside” of the curve and we can prove the above property of simply connected regions.

Definition

If Γ is a smooth closed curve, we say that a point $z_0 \notin \Gamma$ is *inside* Γ if $\int_{\Gamma} \frac{dz}{z-z_0} \neq 0$. The totality of such points is called the *inside of* Γ . Note that a similar definition (10.4), under more limited circumstances, is given in Chapter 10.

Lemma

If D is a simply connected region, Γ is a closed curve contained in D and $z_0 \in \tilde{D}$, then there exists a differentiable curve $\gamma(t)$ which connects z_0 to ∞ and which does not intersect Γ .

Proof

According to Definition 8.1, there exists a continuous curve γ , connecting z_0 to ∞ with $d(\gamma, \tilde{D}) < \epsilon$. If we take $\epsilon = \frac{1}{2}d(\Gamma, \tilde{D})$, γ will not intersect Γ . Moreover, since $\gamma \rightarrow \infty$, for some N , $t \geq N \Rightarrow |\gamma(t)| \geq \max\{|z| : z \in \Gamma\}$. We can, then, redefine $\gamma(t) = \frac{t}{N}\gamma(N)$ for $t \geq N$ so that γ will be differentiable (γ' will actually be constant) for $t \geq N$. Finally, because $\gamma(t)$, $0 \leq t \leq N$, can be uniformly approximated by a differentiable curve, there exists a curve γ with all of the desired properties. \square

Theorem

If D is a simply connected region and Γ is a smooth closed curve contained in D , then the inside of Γ is contained in D .

Proof

If not, there would be $z_0 \in \tilde{D}$ for which $\int_{\Gamma} \frac{dz}{z-z_0} \neq 0$. Let γ be a differentiable curve, connecting z_0 to ∞ and not intersecting Γ (as in the above lemma), and define

$$I(t) = \int_{\Gamma} \frac{dz}{z - \gamma(t)}, \quad t \geq 0.$$

$I(t)$ can be differentiated with respect to t and

$$I'(t) = \gamma'(t) \int_{\Gamma} \frac{dz}{[z - \gamma(t)]^2}.$$

The above integral is clearly 0 (for all t) since the integrand has, as a primitive, the function $\frac{-1}{z-\gamma(t)}$. Thus we can conclude that $I(t)$ is constant. On the other hand, $I(0) \neq 0$ (since $\gamma(0) = z_0$) and $I(t) \rightarrow 0$ as $t \rightarrow \infty$ since the integrand approaches 0 uniformly, which yields the desired contradiction. \square

II Circulation and Flux as Contour Integrals

Let C be a closed curve given by $z(t) = x(t) + iy(t)$. Then a vector tangent to C is given by

$$\dot{z}(t) = \frac{dx}{dt} + i \frac{dy}{dt}$$

and a normal vector to C is given by

$$\frac{dy}{dt} - i \frac{dx}{dt}.$$

(If C is parametrized so that the tangent points in the counter-clockwise direction, the above normal vector points “outward.”) Suppose $g = u + iv$ represents a flow function throughout C . Then the circulation around C is found by integrating the tangential component of g against the arclength, and the flux across C is given by the corresponding integral of the normal component of g . Let σ, τ represent the circulation and flux, respectively, and recall that the component of a vector \vec{a} in the direction of $\vec{\beta}$ is given by $(\vec{a} \circ \vec{\beta})/|\vec{\beta}|$. Then

$$\sigma = \int_C \left(u \frac{dx}{dt} + v \frac{dy}{dt} \right) dt = \int_C u dx + v dy$$

and

$$\tau = \int_C \left(u \frac{dy}{dt} - v \frac{dx}{dt} \right) dt = \int_C u dy - v dx.$$

Note, finally, that if $f = \bar{g} = u - iv$,

$$\int_C f(z)dz = \int_C (u - iv)(dx + i dy) = \sigma + i\tau.$$

III Steady-State Temperatures; The Heat Equation

Let the function u denote the temperature at the points of a region D and assume that u is independent of time. Then $u = u(x, y)$ is a real-valued function of the position (x, y) , and we wish to show that it is harmonic. To this end, we note two basic facts:

1. Heat flows in the direction of cooler temperatures, and the amount of heat crossing a curve per unit of time is proportional to the length of the curve and the difference in temperature across the two sides. Thus the amount of heat crossing a horizontal line of length Δx is equal to $Ku_y \Delta x$, while the amount of heat crossing a vertical line of length Δy is given by $Ku_x \Delta y$.
2. The total increase in heat (the amount of heat entering minus the amount of heat leaving) in any square $S \subset D$ must be zero. Otherwise, the temperature at points of S would change, contrary to our assumption that u is independent of time.

Using these two facts, we can obtain the following proof that u is harmonic, assuming $u \in C^2$.

Suppose that S is any square in D with horizontal and vertical sides of length h and assume without loss of generality that the lower left vertex is $(0,0)$. Note that for any function $f(x, y)$ with continuous partial derivatives at the origin,

$$\begin{aligned} f(x, y) - f(0, 0) &= f(x, y) - f(x, 0) + f(x, 0) - f(0, 0) \\ &= yf_y(x, \zeta) + xf_x(\eta, 0) \end{aligned}$$

so that

$$(3) \quad f(x, y) - f(0, 0) = y(f_y(0, 0) + \epsilon_1) + x(f_x(0, 0) + \epsilon_2)$$

where ϵ_1 and $\epsilon_2 \rightarrow 0$ as $(x, y) \rightarrow (0, 0)$. To obtain a formula for the change in the amount of heat in S per unit time, we first calculate the loss of heat through the top side minus the increase through the bottom side. According to (1), over any subinterval Δx , this is given by

$$[Ku_y(x, h) - Ku_y(x, 0)]\Delta x.$$

But according to (3),

$$\begin{aligned} u_y(x, h) &= u_y(0, 0) + xu_{yx}(0, 0) + hu_{yy}(0, 0) + \epsilon_1x + \epsilon_2h \\ u_y(x, 0) &= u_y(0, 0) + xu_{yx}(0, 0) + \epsilon_3x \end{aligned}$$

so that

$$u_y(x, h) - u_y(x, 0) = hu_{yy}(0, 0) + \epsilon_4h$$

where $\epsilon_4 \rightarrow 0$ as $h \rightarrow 0$. The net decrease in heat from the (two) subintervals thus equals $K [hu_{yy}(0, 0) + \epsilon_4 h] \Delta x$, and the net loss through the top and bottom sides is given by

$$K [h^2 u_{yy}(0, 0) + \epsilon_4 h^2].$$

Similarly, the net loss through the vertical sides is given by

$$K [h^2 u_{xx}(0, 0) + \epsilon_5 h^2].$$

and since the overall decrease must be zero,

$$u_{xx}(0, 0) + u_{yy}(0, 0) + \epsilon_4 + \epsilon_5 = 0.$$

Since, finally, h could have been chosen as small as possible, we conclude

$$u_{xx}(0, 0) + u_{yy}(0, 0) = 0$$

and since the origin is in no way special, it follows that u is harmonic throughout D .

Index

- Absolute value, 5
- Absolutely convergent
 - product, 245
 - sum, 13
- Analytic
 - arc, 102, 206
 - branch of $\log z$, 113
 - continuation, 257, 263
 - function, 38
 - part, 124
 - polynomial, 21, 23
- Angle between curves, 169
- Annulus, 120, 232
- Arc length, 50
- Argand, J., 4
- Argument, 6
 - Principle, 136
- Associative law, 2
- Automorphism, 182
- Axis
 - imaginary, 4
 - real, 4

- Barrier, 197
- Bilinear transformation, 177
- Binomial coefficients, 154
- Boundary, 13
 - natural, 259
- Bounded set, 13

- C-analytic, 86
- C-harmonic, 229
- Canonical regions, 200
- Carathéodory
 - proof of open mapping theorem, 93
 - proof of Rouché's theorem, 142
- Carathéodory-Osgood Theorem, 205

- Cardan, J., 1, 11
- Casorati-Weierstrass Theorem, 119
- Cauchy
 - product, 28, 33
 - Residue Theorem, 133
 - sequence, 12
- Cauchy Integral Formula
 - for analytic functions, 79
 - for entire functions, 61, 74
 - general, 138
- Cauchy-Riemann Equations, 24, 35, 36
- Chebychev, 286, 287
- Circle of convergence, 27, 257
- Circulation, 322
- Closed curve, 52
- Closed Curve Theorem
 - for analytic functions, 78
 - for entire functions, 56
 - general, 112
- Closed set, 13
- Closure, 13
- Commutative law, 2
- Compact, 14
- Complement, 13
- Complex
 - integral, 45
 - number, 1
 - plane, 4
- Conformal
 - equivalence, 169, 172, 175
 - mapping, 169, 175
- Conjugate, 5
- Connected set, 14
- Continuous function, 14
- Convergence
 - absolute, 13, 243
 - circle of, 27, 257

- of Newton's method, 71
- quadratic, 72
- radius of, 26
- uniform, 15, 99
- Convergent
 - integral, 143, 144, 147
 - product, 241
 - sequence, 12
- Convex, 67
- Critical point, 87
- Cross-ratio, 185
- Cubic equation, 9
- Curve
 - closed, 52
 - Jordan, 132
 - level, 238
 - piecewise differentiable, 45
 - regular closed, 133
 - simple closed, 52
 - smooth, 45
- Curves
 - smoothly equivalent, 46
- Cyclotomic equation, 19

- Define Integral
 - complex, 45
 - real, 143
- Deleted neighborhood, 117
- Dense set, 119
- Derivative
 - complex, 24, 35
 - partial, 23
- Descartes, R., 1
- Differentiable function, 24
- Differential equation, 222
- Dirichlet Problem, 229
- Dirichlet series, 251
- Disconnected, 14
- Distributive law, 2

- Entire function, 38
- Equicontinuous set of functions, 202
- Essential singularity, 118
- Euler
 - constant, 268
 - theorem, 282
- Euler, L., 1
- Exponential function, 40
- Extended plane, 18

- Field of complex numbers, 1
- Fixed point, 70, 184
- Fluid flow
 - locally irrotational and source-free, 195
 - totally irrotational and source-free, 197
- Flux, 195, 322
- Fourier Uniqueness Theorem, 275
- Fraction, partial, 125
- Function
 - analytic, 38
 - complex continuous, 14
 - differentiable, 24
 - entire, 38
 - even, 74
 - exponential, 40
 - Gamma, 265
 - harmonic, 225
 - inverse, 38, 174
 - locally 1-1, 170
 - logarithm, 113
 - meromorphic, 135
 - of z , 21
 - rational, 125
 - trigonometric, 41
 - Zeta, 257, 268
- Functions, equicontinuous, 202
- Fundamental Theorem of Algebra, 66, 91
- Fundamental Theorem of Calculus, 51

- Gamma Function, 265
- Gauss, C., 1
- Gauss-Lucas theorem, 67
- Generating functions, 273, 277, 278

- Hadamard, viii
- Hamilton, W., 1
- Harmonic function, 225
- Heat Equation, 322, 323
- Hurwitz's Theorem, 139

- Imaginary
 - axis, 4
 - part, 5
- Infinite product, 241
- Infinity, point at, 17
- Integral, 147
 - complex definite, 45
 - line, 46
 - real definite, 143
- Integral Theorem
 - for analytic functions, 78, 111
 - for entire functions, 54
- Inverse function, 38
- Isolated singularity, 117
- Isomorphism, 2

- Jordan Curve Theorem, 132
- Jordan region, 205

- Kelvin's Theorem, 199
- Kernel function
 - Poisson, 228
- Landau
 - proof of the maximum modulus theorem, 91
 - theorem, 263
- Laplace
 - Equation, 232
 - transform, 262
- Laurent expansion, 120
 - analytic part, 124
 - principal part, 124
- Laurent series, 120
- Level curve, 238
- Levels of polygonal path, 109
- Lim sup, 26
- Liouville's Theorem, 65, 96
 - Extended, 66
 - for $\operatorname{Re} f$, 234
- Locally 1-1, 170
- Logarithm function, 113

- M-L Formula, 49
- M-Test, 15
- Mapping
 - bilinear, 177
 - conformal, 169
 - Theorem, 200
- Maximum Modulus Theorem
 - for analytic functions, 86
 - for harmonic functions, 227
 - generalized, 215
- Mean-Value Theorem
 - for analytic functions, 85
 - for harmonic functions, 226
- Meromorphic function, 135
- Minimum Modulus Theorem, 87
- Modulus, 5
- Moments, 261
- Morera's Theorem, 98

- Neighborhood, 13
 - deleted, 117
- Newton basins, 73
- Newton's method, 68

- Open Mapping Theorem, 93
- Order
 - in the complex plane, 4
 - of a pole, 118
 - of a zero, 67
 - Order of an entire function, 236, 239
- Partial derivative, 23
- Partial fraction decomposition, 125
- Partition problem, 278
- Phragmén-Lindelöf Theorem, 218
- Picard's Theorem, 120
- Piecewise differentiable curve, 45
- Plane
 - complex, 4
 - extended, 18
- Point
 - at infinity, 16
 - fixed, 70, 184
 - regular, 258
 - saddle, 89
- Poisson Integral Formula
 - for a disc, 229
 - for a half-plane, 229
- Poisson Kernel, 228
- Polar coordinates, 8
- Pole, 118
- Polygonal line, 14
- Polygonal path, 16
 - levels of, 109
- Polygonally connected, 14
- Polynomial
 - analytic, 21
 - real, 18, 74
- Power series, 25, 28, 80
- Prime number theorem, 285
- Principal parts, 124

- Quadratic equation, 3

- Radius of convergence, 26
- Rational function, 125
- Real
 - axis, 4
 - part, 5, 225, 226
 - polynomial, 18, 74
- Rectangle Theorem
 - for analytic functions, 77
 - for entire functions, 52, 59
- Reflection Principle, 101
- Region, 14
 - convex, 116
 - simply connected, 107
- Regular closed curve, 133
- Regular point, 258
- Removable singularity, 117
- Residue, 129
- Residue Theorem, 133
- Riemann
 - Mapping Theorem, 200
 - Principle of Removable Singularities, 118

- sphere, 17
- Rotation, 175
- Rouché's Theorem, 137, 142

- Saddle point, 89
- Schwarz
 - Lemma, 94
 - Reflection Principle, 101
- Schwarz-Christoffel transformation, 187
- Sequence
 - Cauchy, 12
 - Convergent, 12
- Series, 12
 - Dirichlet, 251
 - power, 26, 28, 80
- Simply connected, 107, 321
- Singularity, 258
 - essential, 118
 - isolated, 117
 - removable, 117
- Sphere
 - Riemann, 16
- Square root, 3
- Stereographic projection, 16
- Streamlines, 213

- Tangent to a curve, 169, 322
- Taylor Expansion
 - for an analytic function, 80
 - for an entire function, 63
- Triangle inequality, 5, 19

- Uniform convergence
 - on compacta, 99
- Uniqueness Theorem
 - for analytic functions, 83
 - for power series, 31

- Value
 - absolute, 5
- Variation, 273
- Vector sum, 4
- Velocity vector, 196

- Wallis, J. , 4
- Weierstrass Product Theorem, 244
- Winding number, 130

- Zero of multiplicity k , 67, 75
- Zeroes of a real polynomial, 18
- Zeroes of entire functions, 236, 244
- Zeta function, 257, 268