



# Standard Practice for Establishing Shipbuilding Quality Requirements for Hull Structure, Outfitting, and Coatings<sup>1</sup>

This standard is issued under the fixed designation F 2016; the number immediately following the designation indicates the year of original adoption or, in the case of revision, the year of last revision. A number in parentheses indicates the year of last reapproval. A superscript epsilon (ε) indicates an editorial change since the last revision or reapproval.

## 1. Scope

1.1 This practice consists of three annexes: hull structure, outfitting, and coating. The subject of these annexes was selected for several reasons. Other commercial shipbuilding nations already have in place widely recognized standards of expectations in these areas. These constitute the most significant areas where workmanship is a critical factor in customer satisfaction. The cost associated with the labor involved in these three areas is a significant factor in construction man-hours and overall schedules.

1.2 The standard criteria provided in this practice are intended to apply to conventional, commercial ship construction. In many cases, specialized, nonconventional vessels using nonstandard materials or built-to-serve sole requirements may require unique acceptance criteria that are beyond those provided in this practice.

## 2. Referenced Documents

### 2.1 ASTM Standards:

D 4417 Test Methods for Field Measurement of Surface Profile of Blast-Cleaned Steel<sup>2</sup>

E 337 Test Method for Measuring Humidity with a Psychrometer (the Measurement of Wet-Bulb and Dry-Bulb Temperatures)<sup>3</sup>

### 2.2 ISO Standards:<sup>4</sup>

ISO 8502-3 Assessment of Dust on Steel Surfaces Prepared for Painting (Pressure-Sensitive Tape Method)

ISO 8502-6 Extraction of Soluble Contaminants for Analysis—The Bresle Method

### 2.3 NACE Standards:<sup>5</sup>

NACE No. 5 Surface Preparation and Cleaning of Steel and

Other Hard Materials by High-and Ultrahigh-Pressure Water Jetting Prior to Re-coating (SSPC-SP 12)

NACE No. 7 Interim Guide and Visual Reference Photographs for Steel Cleaned by Water Jetting (SSPC-VIS 4(1))

### 2.4 SSPC Standards:<sup>6</sup>

SSPC-AB 1 Mineral and Slag Abrasives

SSPC-AB 2 Specification for Cleanliness of Recycled Ferrous Metallic Abrasives

SSPC-PA 2 Measurement of Dry Coating Thickness With Magnetic Gages

SSPC-SP 1 Solvent Cleaning

SSPC-SP 2 Hand Tool Cleaning

SSPC-SP 3 Power Tool Cleaning

SSPC-SP 7 Brush-Off Blast Cleaning

SSPC-SP 10 Near-White Blast Cleaning

SSPC-SP 11 Power Tool Cleaning to Bare Metal

SSPC-SP 12 Surface Preparation and Cleaning of Steel and Other Hard Materials by High-and Ultrahigh-Pressure Water Jetting Prior to Re-coating (NACE No. 5)

SSPC-VIS 1-89 Visual Standard for Abrasive Blast Cleaned Steel

SSPC-VIS 3 Visual Standard for Power- and Hand-Tool Cleaned Steel

SSPC-VIS 4(1) Interim Guide and Visual Reference Photographs for Steel Cleaned by Water Jetting (NACE No. 7)

### 2.5 NSRP Documents:<sup>7</sup>

National Shipbuilding Research Project 6-97-1 “American Shipbuilding Quality Standards,” dated May 28, 1999

## 3. Summary of Practice

3.1 This practice provides workmanship criteria to be applied to commercial shipbuilding or ship repair, or both. The criteria covers three primary phases of ship construction, that is, hull structure, outfitting, and coatings. Specific criteria to be

<sup>1</sup> This practice is under the jurisdiction of ASTM Committee F-25 on Ships and Marine Technology and is the direct responsibility of Subcommittee F25.07 on General Requirements.

Current edition approved May 10, 2000. Published October 2000.

<sup>2</sup> *Annual Book of ASTM Standards*, Vol 06.02.

<sup>3</sup> *Annual Book of ASTM Standards*, Vol 11.03.

<sup>4</sup> Available from American National Standards Institute, 11 W. 42nd St., 13th Floor, New York, NY 10036.

<sup>5</sup> Available from National Association of Corrosion Engineers, PO Box 218340, Houston, TX 77218.

<sup>6</sup> Available from Society for Protective Coatings, 40 24th St., 6th Floor, Pittsburgh, PA 15222-4656.

<sup>7</sup> Available from The Librarian, Documentation Center, Marine Systems Division, University of Michigan Transportation Research Institute, 2901 Baxter Rd., Ann Arbor, MI 48109-2150.

selected from this standard should be as contractually agreed between the ship owner and shipbuilder.

#### **4. Significance and Use**

4.1 To achieve success in ship construction, it is necessary for the ship owner and the ship builder to agree on the level of quality in the final product. Classification rules, regulatory requirements, and ship specifications all help to define an acceptable level of construction quality; however, this guidance alone is not sufficient. It is up to the shipbuilder, therefore, to describe the level of workmanship sufficiently that will be reflected in the delivered ship, and for the ship owner to communicate his expectations effectively for the final product.

4.2 It is the intent of this document to contribute to these objectives in the following ways:

4.2.1 To describe a reasonable acceptable level of workmanship for commercial vessels built in the United States.

4.2.2 To provide a baseline from which individual shipyards can begin to develop their own product and process standards in accordance with generally accepted practice in the commercial marine industry.

4.2.3 To provide a foundation for negotiations between the shipbuilder and the ship owner in reaching a common expectation of construction quality.

4.3 The acceptance criteria herein are based on currently practiced levels of quality generally achieved by leading international commercial shipbuilders. These criteria are not intended to be a hard standard with which all U.S. shipyards must comply. Rather, they are intended to provide guidance and recommendations in the key areas that play a major role in customer satisfaction and cost-effective ship construction.

#### **5. Keywords**

5.1 coatings; hull structure; outfitting; quality; shipbuilding; workmanship

## **ANNEXES**

### **(Mandatory Information)**

#### **A1. HULL STRUCTURE**

I. HULL STRUCTURE		SHIPBUILDING QUALITY STANDARDS			
Division		Marking		UNIT:mm	
Section	Sub-section	Item	Standard Range	Tolerance Limits	Remarks
Cutting line and fitting line compared with correct ones	General members	Size and shape compared with correct ones.	± 2	± 3	
			± 1.5	± 2.5	Especially for the depth of floors and girders of double bottom.
		Corner angle compared with correct ones	± 1.5	± 2	
		Curvature	± 1	± 1.5	
		Location of member & mark for fitting compared with correct ones.	± 2	± 3	
		Block marking(Panel block) compared with correct ones.	± 2.5	± 3.5	
		Location of member for fitting compared with correct ones.	± 2.5	± 3.5	

FIG. A1.1 Hull Structure

I. HULL STRUCTURE					SHIPBUILDING QUALITY STANDARDS		
Division		Gas Cutting			UNIT:mm		
Section	Sub-section	Item	Standard Range	Tolerance Limits	Standard Range	Tolerance Limits	Remarks
Roughness	Free edge	Strength Shop member Field	100μ (2nd cl) 150μ (3rd cl)	200μ (3rd cl) 300μ (Out cl)			The class denoted in parentheses is in accordance with following definition. Less Than 50μ 1st class 50μ~100μ 2nd class 100μ~200μ 3rd class More than 200μ out of class - Special precautions are required in case where grinding or other treatments are requested. - For angle cutting the same as the case in field.
		Other Shop Field	100μ (2nd cl) 500μ (Out cl)	200μ (3rd cl) 150μ (Out cl)			
	Weld groove	Strength Shop member Field	100μ (2nd cl) 400μ (Out cl)	200μ (3rd cl) 800μ (Out cl)			
		Other Shop Field	100μ (2nd cl) 800μ (Out cl)	1500μ (Out cl) 1500μ (Out cl)			

FIG. A1.2 Hull Structure

I. HULL STRUCTURE		SHIPBUILDING QUALITY STANDARDS	
Division		Material	
Section	Sub-section	Item	Remarks
Surface flaw	Pitting	<p>Grade of pitting</p>	<p>1. Grade A pitting is minor and no repair is necessary. Grade B pitting is moderate and is to be repaired as necessary. Grade C pitting is severe and requires repair.</p> <p>2. Pitting that occurs on the boundary line between Grade A and Grade B can be considered minor and treated as Grade A pitting.</p> <p>3. Repairs shall be made as follows:            Depth of pitting : d            Plate Thickness : t            Where <math>0.07t &gt; d</math> Grind Smooth            (Note: Regardless of plate thickness, at no time should pitting that is 3mm deep or greater be repaired by grinding only)            Where <math>0.2t \geq d \geq 0.07t</math> Grind and Weld</p> <p>Note: The area ratio is the estimated percentage of the plate surface that is pitted to the point where the surface appearance is unsatisfactory.</p>
	Flaking	<p>Grade of surface flaking</p>	<p>1. Grade A pitting is minor and no repair is necessary. Grade B pitting is moderate and is to be repaired as necessary. Grade C pitting is severe and requires repair.</p> <p>2. Pitting that occurs on the boundary line between Grade A and Grade B can be considered minor and treated as Grade A pitting.</p> <p>3. Repairs shall be made as follows:            Depth of pitting : d            Plate Thickness : t            Where <math>0.07t &gt; d</math> Grind Smooth            (Note: Regardless of plate thickness, at no time should pitting that is 3mm deep or greater be repaired by grinding only)            Where <math>0.2t \geq d \geq 0.07t</math> Grind and Weld</p> <p>Note: The area ratio is the estimated percentage of the plate surface that is pitted to the point where the surface appearance is unsatisfactory.</p>
Casting Steel	Details of Casting Steel	Applicable to cases where defects are over 20% of thickness, or over 25mm deep and 150mm long.	When the removal of a surface defect exposes other significant defects such as cavities, cracks or inclusions, the casting is to be checked using dye penetrant inspection, magnetic particle inspection or ultrasonic inspection and repaired accordingly, using an appropriate method of repair.
Delamination	Local delamination	<p>(a)</p> <p>(b)</p>	<p>Where delamination is minor it can be chipped or ground out and built-up with weld metal as shown in Figure (a).</p> <p>Where minor delamination occurs close to the plate surface grinding or chipping and weld metal build-up should be as shown in Figure (b).</p> <p>Repair of moderate delamination should be considered on a case by case basis.</p>
	Severe delamination, requiring a local exchange of plate		<p>Where delamination is fairly extensive, plating should be cropped out locally and replaced.</p> <p>The minimum width of plating to be cropped out is to be as follows:            Highly Stressed Primary Longitudinal Strength Members: 1600mm            Moderately Stressed Primary Longitudinal Strength Members: 800mm            All Other Structural Members: 300mm</p> <p>Where severe delamination that affects the whole plate occurs, the whole plate must be replaced.</p>

FIG. A1.3 Hull Structure

I. HULL STRUCTURE			SHIPBUILDING QUALITY STANDARDS			
Division		Gas Cutting		UNIT: mm		
Section	Sub-section	Item	Standard Range	Tolerance Limits	Remarks	
Notches & indentations Note: A notch is defined as a highly localized indent that is three times deeper than the tolerance limits for normal roughness.	Free edge	1) Upper edge of sheer strake. 2) Strength deck between 0.6l $\phi$ and free edge of opening of shell plate. 3) Main long strength members.		Notch 0	Notches are to be welded up prior to grinding in areas where a smooth finish is required. Sufficient weld metal should be laid such that after grinding there are no residual voids or cracks between the weld metal and the parent metal.	
		Longitudinal & Transverse Strength members		Indentation S1	Indentations greater than the stated tolerance limit are to be treated as notches.	
		Others		Indentation S3	Indentations greater than the stated tolerance limit are to be treated as notches.	
	Weld groove	Butt Weld	Shell plate & Upperdeck between 0.6l $\phi$		Indentation S2	Indentations greater than the stated tolerance limit are to be treated as notches.
			Others		Indentation S3	Indentations greater than the stated tolerance limit are to be treated as notches.
		Filllet Weld		Indentation S3	Indentations greater than the stated tolerance limit are to be treated as notches.	
Dimension	Straightness of plate edge	Both side submerged arc welding	$\pm 0.4$	$\pm 0.5$		
		Manual welding; semi automatic welding	$\pm 1.0$	$\pm 2.5$		
	Depth of edge preparation		$\pm 1.5$	$\pm 2.0$		
	Angle of edge preparation		$\pm 2^\circ$	$\pm 4^\circ$		
	Length of taper	 (l compared with correct sizes)	$\pm 0.5d$	$\pm 1.0d$		
	Size of member	Structural members other than double bottom floors and girders.	$\pm 3.5$	$\pm 5.0$		
		Depth of double bottom floors and girders.	$\pm 2.5$	$\pm 4.0$		
		Breadth of face bar.	$\pm 2.0$	-3.0 ~ +4.0		
	Edge preparation	Automatic welding	$\pm 2^\circ$	$\pm 4^\circ$		
Semi-automatic & manual welding.		$\pm 2^\circ$	$\pm 4^\circ$			

FIG. A1.4 Hull Structure

I. HULL STRUCTURE			SHIPBUILDING QUALITY STANDARDS		
Division		Fabrication		UNIT: mm	
Section	Sub-section	Item	Standard Range	Tolerance Limits	Remarks
Flanged Longitudinal	Breadth of flange	 Compared with correct size	±3.0	±5.0	
	Depth of web	 Compared with correct size	±3.0	±5.0	Low and moderately stressed members.
			±2.0	±3.0	Highly stressed members.
	Angle between flange and web	 Compared with template per 100 mm in breadth of flange	±2.5	±4.5	
	Curvature or straightness in the plane of flange	 Per 10m in length	±10	±25	
	Curvature or straightness in the plane of web	 Per 10m in length	±10	±25	

FIG. A1.5 Hull Structure

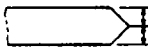
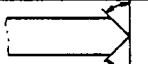
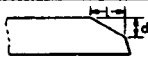

I. HULL STRUCTURE		SHIPBUILDING QUALITY STANDARDS				
Division		Fabrication		UNIT: mm		
Section	Sub-section	Item	Standard Range	Tolerance Limits	Remarks	
Angle & Built up plate	Stringer angle	 Compared with template	±1.5	±2.0		
		 Compared with template	±1.0	±1.5	Maximum permitted curvature per 100mm length of member.	
	Frame & Long	Curvature compared with template or check line. Per 10m in length.	±2.0	±4.0		
		Deviation from.  Inscribed curve Correct from inscribed.	±3.0	±5.0		
		 Deviation in flange angle Compared with template	±1.5	±3.0		
		Deviation of face plate		±1.5 per 100mm	±3.0 per 100mm	

FIG. A1.6 Hull Structure

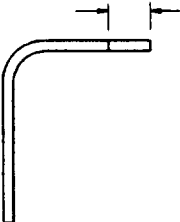
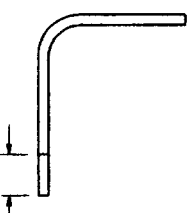
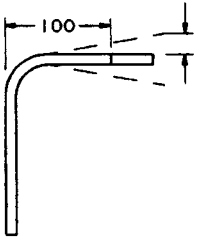
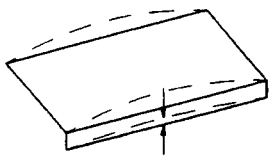
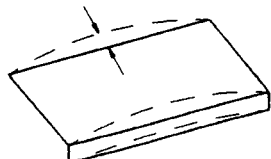

I. HULL STRUCTURE		SHIPBUILDING QUALITY STANDARDS			
Division		Fabrication		UNIT: mm	
Section	Sub-section	Item	Standard Range	Tolerance Limits	Remarks
Flanged Bracket	Breadth of flange	 <p>Compared with correct size</p>	±3.0	±5.0	
	Angle between flange and web	 <p>Compared with template per 100 mm in breadth of flange</p>	±3.0	±5.0	
Bending templates (plane or box shape).	Templates for box shapes	Actual line of plate edge, compared with template.	±2.0	±4.0	
		Actual curved surface, compared with template.	±2.0	±4.0	For dimensions greater than 1M, ±5.0.
	Section templates	Location of check line for leveling by sight, compared with template. (for transverse)	±1.5	±3.0	
		Location of check line for leveling by sight, compared with template. (for longitudinal)	±1.5	±3.0	
		Shape, compared with template.	±1.5	±3.0	
Other templates	Shape, compared with template.	±1.5	±3.0		

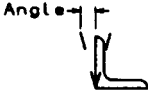
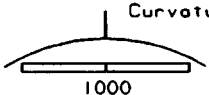
FIG. A1.7 Hull Structure

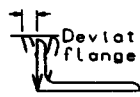
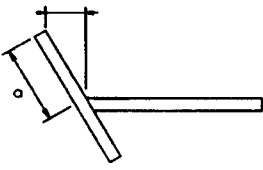
I. HULL STRUCTURE		SHIPBUILDING QUALITY STANDARDS				
Division		Fabrication			UNIT: mm	
Section	Sub-section	Item	Standard Range	Tolerance Limits	Remarks	
Plate	Corrugated bulkhead	Depth of corrugation	±3.0	±6.0		
		Breadth of corrugation. 	A	±3.0	±6.0	
			B	±3.0	±6.0	
	Corrugated wall 	Pitch (p)		±6.0	±9.0	
				±2.0	±3.0	
		Depth (h)	±2.5	±5.0		
	Cylindrical structure (most, post etc) 	Diameters		$\frac{\pm D}{200}$ But, Max. ±5.0	$\frac{\pm D}{150}$ But, Max. ±7.5	
	Curved shell (ate)	In regard to the check line (for longitudinal)		±2.5	±5.0	
		(for transverse)		±2.5	±5.0	
		Gap between shell plate and section template		±2.5	±5.0	

FIG. A1.8 Hull Structure

I. HULL STRUCTURE			SHIPBUILDING QUALITY STANDARDS		
Division		Sub-assembly		UNIT: mm	
Section	Sub-section	Item	Standard Range	Tolerance Limits	Remarks
Accuracy of Dimensions	Block Sub-assembling including Stern frame	Distance between aft edge of boss and aft peak bulkhead (b)	±5	±10	
		Twist of Sub-assembly (c)	±5	±10	
		Deviation of rudder from shaft & (d)	±4	±8	
	Rudder	Twist of Rudder plate over its length	±6	±10	Correct or re-assemble partially
	Main engine bed	Flatness of top plate of main engine bed	±5	±10	
		Breadth and length of top plate of main engine bed	±4	±6	
		Others	The same as for flat plate block Sub-assembly		

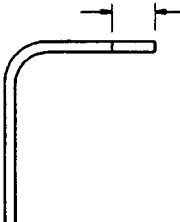
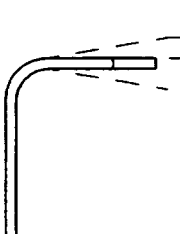
FIG. A1.9 Hull Structure

I. HULL STRUCTURE		SHIPBUILDING QUALITY STANDARDS				
Division		Sub-assembly		UNIT: mm		
Section	Sub-section	Item	Standard Range	Tolerance Limits	Remarks	
Accuracy of Dimensions	Flat plate Sub-assembly	Breadth of Sub-assembly	±4.0	±6.0	Cut, when too long	
		Length of Sub-assembly	±4.0	±6.0	Cut, when too long	
		Squareness of Sub-assembly	±4	±8	Measured difference of diagonal length of final marking lines. When the difference is over the limits, correct the final marking line.	
		Distortion of Sub-assembly	±10	±20	Measured on the face of web or girder.	
		Deviation of Interior members from shell plating	±5.0	±10.0	Excluding the case when interior members are connected by lapped joint.  Accuracy of this dimension	
	Curved plate Sub-assembly	Breadth of Sub-assembly	±4.0	±8.0	Measured along the girth. Cut, when too long.	
		Length of Sub-assembly	±4.0	±8.0	Cut, when too long.	
		Distortion of Sub-assembly	±10	±20	Measured on face of web or girder. Correct the final marking line, when the distortion exceeds the limits.	
		Squareness of Sub-assembly	±10	±15	Difference of base line to marking or difference of diagonal lengths along marking  $d =  e1 - e2 $ adjust marking where practicable.	
		Deviation of Interior members from shell plating	The same as for the flat plate Sub-assembly above.			
	Plate Block Sub-assembly	Breadth of each panel	The same as for the flat plate Sub-assembly above.			
		Length of each panel				
		Squareness of each panel				
		Distortion of each panel				
		Distortion of Interior members from skin plating				

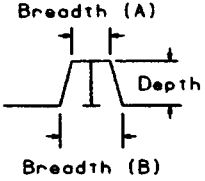
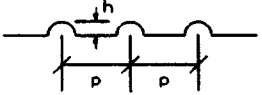
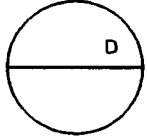
FIG. A1.10 Hull Structure

I. HULL STRUCTURE		SHIPBUILDING QUALITY STANDARDS				
Division		Sub-assembly		UNIT:mm		
Section	Sub-section	Item	Standard Range	Tolerance Limits	Remarks	
Accuracy of Dimensions	Plate Block Sub-assembly	Twist of Sub-assembly	±10	±20	Measured as follows:  The points A, B and C are established in the same plane. Measure the deviation of point D from that plane. May re-assemble partially when the deviation exceeds the limits.	
		B.L. = baseline				
		Deviation of upper/lower panel from $\epsilon$ or B.L.	±5	±10	 Accuracy of this dimension	
	Deviation of upper/lower panel from $\epsilon$ or FR.L.	±5	±10			
	Plate Block Sub-assembly	Breadth of each panel				The same as for the flat plate Sub-assembly (previous page)
		Length of each panel				
		Distortion of each panel				
		Deviation of interior members from skin plating				
		Twist of Sub-assembly	±15	±25	The same as for the flat plate Sub-assembly (previous page)	
	Block Sub-assembly including stern frame	Plate Block Sub-assembly	Deviation of upper/lower panel from $\epsilon$ or B.L.	±7	±15	Re-assemble partially when the deviation exceeds the limits
Deviation of upper/lower panel from $\epsilon$ or FR.L.			±7	±15		
Block Sub-assembly including stern frame		Distance between upper/lower gudgeon (a)	±5.0	±10.0		

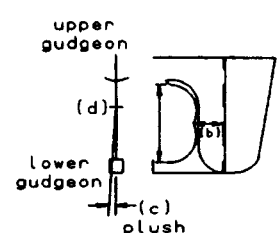
FIG. A1.11 Hull Structure

I. HULL STRUCTURE		SHIPBUILDING QUALITY STANDARDS			
Division		accuracy		UNIT: mm	
Section	Sub-section	Item	Standard Range	Tolerance Limits	Remarks
Principal Dimensions	Length	Length between Perpendiculars	±50.0 Per 100M	Not defined	Applied to ships of 100 meters length and below. For the convenience of the measurement the point where the keel is connected to the curve of the stem may be substituted for the fore perpendicular in the measurement of the length.
		Length between aft edge of boss and main engine	±25.0	Not defined	
	Breadth	Molded breadth Amidships	±15.0	Not defined	Applied to ships of 15 meters breadth and above. Measured on the upper deck.
	Depth	Molded depth Amidships	±10.0	Not defined	Applied to ships of 10 meters depth and above.
Deformation of hull form	Flatness of Keel	Deformation for the whole length	±25.0	Not defined	Ups(-) and Downs(+) against the check line of keel sighting.
		Deformation for the distance between two adjacent bulkheads	±15.0	Not defined	Sighting by the transit or using slits.
	Forebody Alignment	Alignment of fore-body to baseline. 	±30.0	Not defined	Ups(-) and Downs(+) against the baseline of the keel at the foremost frame on the flat part of the keel.
		Alignment of aft-body to baseline. 	±20.0	Not defined	Ups(-) and Downs(+) against the baseline of the keel at the aft-perpendicular.
Rise of Floor	Rise of floor amidships 	±15.0	Not defined	The height of the lower turn of the bilge, compared with the planned height. Measured from the plane passing through the outer surface of the keel plate.	

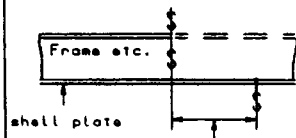
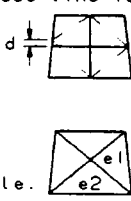
FIG. A1.12 Hull Structure

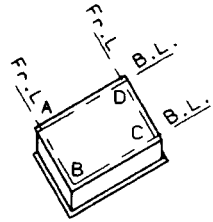
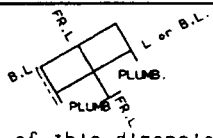

I. HULL STRUCTURE		SHIPBUILDING QUALITY STANDARDS		
Division		Welding		UNIT: mm
Section	Sub-section	Item	Tolerance Limits	Remarks
Shape of bead	Height of reinforcement Breadth of bead Flank angle		 h: not defined B: not defined $e \leq 90^\circ$	 In case where e is over $90^\circ$ it is to be repaired by grinding or welding to make $e \leq 90^\circ$
	Under cut (butt weld)	Shell plate and face plate between 0.6l	over 90mm continuous $d \leq 0.5$ 	Repair using fine electrode. (Avoid short beads for higher tensile steel)
		Other	$d \leq 0.8$	
	Under cut (fillet weld)			
Leg length	Compared with Correct ones (l, d)		 l: Leg length d: Throat depth $\geq 0.9l$ $\geq 0.9d$	When over tolerance limits, weld up. (Avoid short beads for higher tensile steels)
Distortion of welding joint	Angular distortion of welding joint	Shell plate between 0.6L <sub>ox</sub>	 span of frame or beam WS6	When over tolerance limits, repair by line heating or re-weld after cutting and re-fitting.
		Fore and Aft shell plating and Transverse strength member	WS7	
		Others	WS8	
Short bead	Tack welding Repairing of bead Repairing of scar	.50HT .Cast steel TMCP type 50HT (ceq. >0.36%)	$\geq 50$	In case where short bead is unavoidable, preheat to $\pm 25^\circ\text{C}$ . If short bead is made inadvertently, remove the bead by grinding, and weld over length of visible crack.
		Grade E of mild steel	$\geq 30$	
		TMCP type 50HT (ceq. $\leq 0.36\%$ )	$\geq 10$	
	Repairing of welding bead	.50HT .Cast steel TMCP type 50HT (ceq. >0.36%)	$\geq 50$	
		Grade E of mild steel	$\geq 30$	
		TMCP type 50HT (ceq. $\leq 0.36\%$ )	$\geq 30$	

FIG. A1.13 Hull Structure

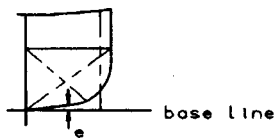
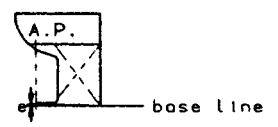
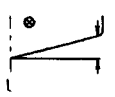
I. HULL STRUCTURE			SHIPBUILDING QUALITY STANDARDS	
Division		Welding		UNIT:mm
Section	Sub-section	Item	Tolerance Limits	Remarks
Arc strike		.50HT .Cast steel .Grade E of mild steel .TMCP type 50HT	not allowed	In case where arc-strike is made inadvertently, remove the hardened zone by grinding or weld over length of short bead on the arc-strike.
Pre-heating	Temperature required pre-heating	TMCP type 50HT (Ceq. ≤0.36%)	T ≤ 0°C	In case where Ceq. of each plate are different in joint, tolerance of higher Ceq. to be applied.
		.50HT Cast steel TMCP type 50HT (Ceq. >0.36%)	T ≤ 5°C	
		Mild steel	T ≤ 5°C	

FIG. A1.14 Hull Structure

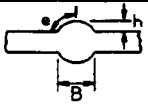
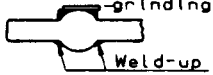

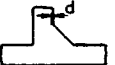
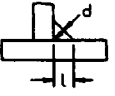
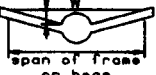





I. HULL STRUCTURE		SHIPBUILDING QUALITY STANDARDS			
Division		Alignment and Finishing		UNIT:mm	
Section	Sub-section	Item	Tolerance Limits	Remarks	
Minimum distance of weld to adjacent weld	Butt weld to butt weld	 	$a \geq 30$		
	Butt weld to fillet weld	 	Main structure	$a \geq 10$	Where beads are parallel.
			Other structure	$a \geq 0$	
			Main structure	$a \geq 5$	
Other structure	$a \geq 0$				
Gap between members	Gap between plate and stiffening member	Stiffening member located perpendicular to plate.  when $C > 3$ , any following treatment can taken. 1)  2)  3) 	$C \leq 3$	Gap between members is to be less than 3mm.	
		Stiffening member located obliquely to plate. (without edge preparation) 			$B \leq 3$
	Through piece and tight plate	 $C1 > C2$	$C1 \leq 3$		

FIG. A1.15 Hull Structure

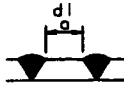
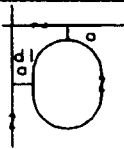

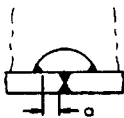
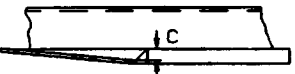

I. HULL STRUCTURE		SHIPBUILDING QUALITY STANDARDS			
Division		Alignment and Finishing		UNIT: mm	
Section	Sub-section	Item	Standard Range	Tolerance Limits	Remarks
Fitting Accuracy	Alignment of fillet joint   a: Difference t: thickness $t \geq t_2$	Strength member		$a \leq 1/3t_2$	$1/3t_2 \leq a \leq 1/2t_2$  to increase leg length by 10% $a > 1/2t_2$ re-fitting
		Others	$a \leq 1/3t_2$	$a \leq 1/2t_2$	$a > 1/2t_2$ re-fitting
	Differences between the beam and the frame   a: Difference	Beam Beamknee Frame	$a \leq 3$	$a \leq 5$	The figure indicates the tolerance that the members can be welded by pulling without taking apart.
Gap before welding	Fillet weld 		$a \leq 2$	$a \leq 3$	① $3 < a \leq 5$ Increased leg length Rule leg + (a-2) ② $5 < a \leq 16$ Welding with bevel preparation or Liner treatment  <u>Welding with bevel preparation</u>   To make bevel edge of web to $30^\circ \sim 45^\circ$ , attach the backing material, and after welding, remove it. Then weld the opposite side. Liner treatment  <u>Liner treatment</u>   ③ $a > 16$ Liner treatment or partial renew   <u>Partial Renew</u>

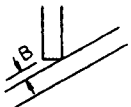
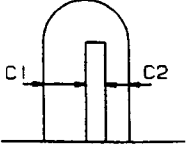
FIG. A1.16 Hull Structure

I. HULL STRUCTURE		SHIPBUILDING QUALITY STANDARDS			
Division		Fabrication		UNIT:mm	
Section	Sub-section	Item	Standard Range	Tolerance Limits	Remarks
Fitting Accuracy	Gap before Welding	<p>Butt weld (manual welding)</p>  <p>a: Gap</p>	$2 \leq a < 3.5$	$a \leq 5$	<p>① <math>5 &lt; a \leq 16</math> After welding, remove backing material, chip and finish weld.</p>  <p>Backing material</p> <p>② <math>16 &lt; a &lt; 25</math> Welding up with edge preparation or partial renew.</p> <p>③ <math>a &gt; 25</math> Partial renew.</p> 
		<p>Butt weld (automatic welding)</p> <p>1. Two side submerged arc welding</p> 	$0 \leq a \leq 0.8$	$a \leq 5$	Where predicted to burn through, weld sealing bead.
		<p>2. Manual or CO<sub>2</sub> submerged arc welding</p> 	$0 \leq a \leq 3.5$	$a \leq 5$	Where a is over 5mm, see manual welding.
		<p>3. One side submerged arc welding with flux copper backing or flux backing</p> 	$0 \leq a \leq 1.0$	$a \leq 3$	Where predicted to burn through, weld sealing bead.
		<p>4. One side submerged arc welding with fiber backing</p> 	$0 \leq a \leq 4$	$a \leq 7$	Where predicted to burn through, adjust by scattering of metal powder or weld sealing bead.

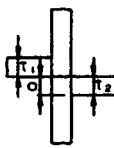
FIG. A1.17 Hull Structure

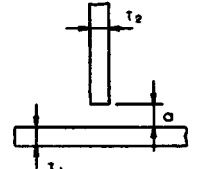
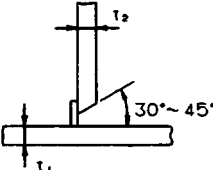
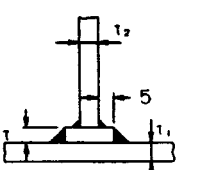
I. HULL STRUCTURE			SHIPBUILDING QUALITY STANDARDS		
Division		Alignment and Finishing		UNIT: mm	
Section	Sub-section	Scope of staging sockets and lifting lugs	Standard Range	Tolerance Limits	Remarks
Staging sockets	In tank	Not to be removed.			<ul style="list-style-type: none"> <li>• Lifting lugs subjected to fatigue to be removed.</li> <li>① Parts ruining appearance and passage to be removed flush to base plate.</li> <li>② Others to be removed by gas cutting at the bond zone.</li> </ul> <div style="text-align: center;">  </div>
	In engine room	Parts of ruining appearance and interfering with clear passage.			
	In hold	Under side of hold and hatch coaming.			
	exposed parts of shell upp DK etc..	To be removed.			
Lifting lugs	In tank	Not to be removed except disturbance of passage.			
	In engine room	Part of ruining appearance and passages.			
	In hold	To be removed except back of deck.			
	exposed parts of shell upp DK etc..	To be removed.			

FIG. A1.18 Hull Structure



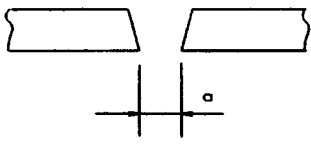
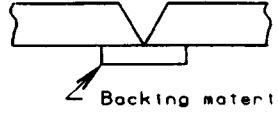
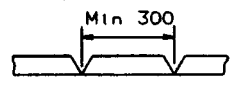
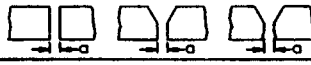
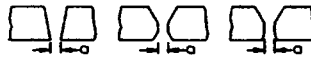
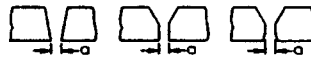
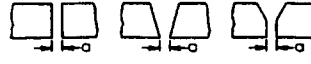

I. HULL STRUCTURE			SHIPBUILDING QUALITY STANDARDS		
Division		Fabrication		UNIT: mm	
Section	Sub-section	Item	Standard Range	Tolerance Limits	Remarks
Fitting Accuracy	Gap before Welding	5. CO <sub>2</sub> one side welding (with backing mat'l) 	2 ≤ a ≤ 8	a ≤ 16	
		6. Electro gas welding 	9 ≤ a ≤ 16	a ≤ 22	
		7. Simplified electric gas welding 	2 ≤ a ≤ 8	a ≤ 10	
		Lap weld 	a ≤ 2	a ≤ 3	① 3 ≤ a ≤ 5 ② a > 5 Re-fitting
	Alignment of butt joint 	Strength member		a ≤ 0.15t (max 3)	a > 0.15t or a > 3 Refitting
		Others		a ≤ 0.2t (max 3)	a > 0.2t or a > 3 Refitting
Cleaning up traces of temporary attachments	Parts requiring good appearance	Outside surface of shell plates. Exposed deck. Exposed super-structure		Grind flush	See Annex A3 for surfaces that are to be painted
	Parts not requiring good appearance	Inside of tank Inside of ceiling Deck to be shield with deck composition etc.		Grind only conspicuous parts finishing	See Annex A3 for surfaces that are to be painted
Surface defect	Scar	Depth (d) Length (e)	10 < e	d ≤ 0.8	① d < 0.07t (Max 3) Grinding or welding ② 0.07t ≤ d welding
			e ≤ 10	d ≤ 1.0	

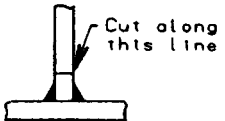
FIG. A1.19 Hull Structure

I. HULL STRUCTURE			SHIPBUILDING QUALITY STANDARDS			
Division		Deformation		UNIT:mm		
Section	Sub-section	Item	Standard Range	Tolerance Limits	Remarks	
Flatness of plate between frame	Shell plate	Parallel part side	4	6		
		Parallel part bottom	4	6		
			Fore and aft part	5		7
		Double bottom tank top plate		4		6
		Bulkhead	Longl Bulkhead Trans Bulkhead Swash Bulkhead	6		8
	Strength deck	Parallel part (Between 0.61e)		4		6
		Fore and aft part		6		9
		Covered part		7		9
	Second deck	Exposed part		6		8
		Covered part		7		9
	Fore-castle deck Poop deck	Exposed part		4		6
		Covered part		7		9
	Super Structure deck	Exposed part		4		6
		Covered part		7		9
		Cross deck		5		7
	House bulkhead	Outside bulkhead		4		6
		Inside bulkhead		4		6
		Covered part		7		9
		Interior member	Web of girder,trans	5		7
		Floor and girder of double bottom		6		8

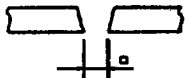
FIG. A1.20 Hull Structure

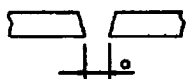
I. HULL STRUCTURE			SHIPBUILDING QUALITY STANDARDS		
Division		Alignment and Finishing		UNIT:mm	
Section	Sub-section	Item	Standard Range	Tolerance Limits	Remarks
Treatment of temporary hull cuts	D<200	Strength member in skin plate		Ⓐ or Ⓑ	Open the hole to over 75φmm  Open the hole to over 200φmm
		Others		Ⓑ, Ⓒ or Ⓓ	In case Ⓑ, open the hole to over 200φmm
	D≥200	Strength member in skin plate		Ⓑ	Method of treatment Ⓐ Spigot patch  $\alpha=30^{\circ}\sim 40^{\circ}$ $G=4\%\sim 6\%$ $t_1=1/2t\sim t$ $e=50\%$
		Others		Ⓑ or Ⓒ	
		Serration, Scallop Slot.			Ⓑ or Ⓒ

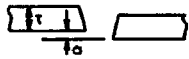
FIG. A1.21 Hull Structure

I. HULL STRUCTURE			SHIPBUILDING QUALITY STANDARDS			
Division		Deformation		UNIT: mm		
Section	Sub-section	Item	Standard Range	Tolerance Limits	Remarks	
Deviation of frame	Shell plate	Parallel part	$\pm 2e/1000$	$\pm 3e/1000$		
		Fore and aft part	$\pm 3e/1000$	$\pm 4e/1000$		
	Deck and top plate of double bottom		$\pm 3e/1000$	$\pm 4e/1000$		
	Bulkhead		$\pm 4e/1000$	$\pm 5e/1000$		
	Accommodation	Deck		$\pm 3e/1000$		$\pm 4e/1000$
		Outside bulkhead		$\pm 2e/1000$		$\pm 3e/1000$
	Others			$\pm 5e/1000$		$\pm 6e/1000$
Miscellaneous	Distortion of deep girder and transverse (at the part of upper edge and flange)	Length of span	5	8		
	Distortion of longitudinal and transverse frame, beam and stiffener (at the part of flange).	$e \leq 1000$	5	8		
		$1000 < e$	$3 + \frac{2e}{1000}$ (max 10)	$6 + \frac{2e}{1000}$ (max 13)		
	Distortion of H pillar between decks.		4	6		
	Distortion of cross tie.	Distortion of fore and aft direction. $e_1$ (cross tie only)		6	10	
		Distortion of fore and aft direction. $e_1$ (cross tie + trans web)		12	16	
	Distortion of tripping bkt and small stiffener with web plate.	Distortion at the part of free edge.			$t_1$	
	Distortion of face plate			$a = 2 + \frac{b}{100}$	$a = 5 + \frac{b}{100}$	

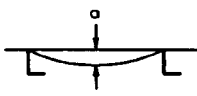
FIG. A1.22 Hull Structure

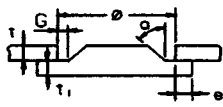

I. HULL STRUCTURE			SHIPBUILDING QUALITY STANDARDS		
Division		Miscellaneous			
		UNIT: mm			
Section	Sub-section	Item	Standard Range	Tolerance Limits	Remarks
Painting for welded joint or tightness test or construction inspection	Sub assembly and assembly welded joint		Paint after hull block inspection	Not defined	Shop primer can be applied.
	Erection welded joint		Paint after tightness test. Butts of Skin PLTS are coated after final construction inspection. Paint before tightness test, when tanks given special protective coating are hydraulically tested.	Butts of Skin PLTS are coated after final construction inspection and before leak test.	
Draft Mark	Compared to the template		±1.0	±2.0	
Freeboard Mark	Compared to the template		±0.5	±0.5	

FIG. A1.23 Hull Structure

I. HULL STRUCTURE			SHIPBUILDING QUALITY STANDARDS		
Division		Miscellaneous		UNIT:mm	
Section	Sub-section	Item	Standard Range	Tolerance Limits	Remarks
Hatch Coaming	Principal dimensions of hatch coaming	Length	±5	±10	
		Breadth	±5	±10	
		Difference of diagonal length	±10	±15	
	Deformation of horizontal stiffener	End coaming	±3	±5	
		Side coaming	±5	±8	
		Deformation per one meter (random)	±2	±3	
Opening of entrance	Opening of steel wall	Breadth and Height	±4	±7	
		Sill height	0~15	-10~+30	
		Deformation (per 1m)	±2	±3	
	Opening of deck (through type)	Breadth	±2	±3	
		Length	±3	±3	
	Opening of deck (not through type)	Breadth	-3~+2	-5~+3	
		Length	-3~+2	-5~+3	

FIG. A1.24 Hull Structure

**A2. OUTFITTING**

I. PIPING							
Division		A. PIPE FABRICATION		SHIPBUILDING QUALITY STANDARDS			
Section		1. STRAIGHT PIPE					
Sub-section	Item	Figure	Nominal Diameter (mm)	Standard Range (mm)	Tolerance Limits (mm)	Remarks	
	Indicated length of pipe on drawing	$l$					
	Length tolerance	$d$		$\pm 6$	Not Defined		
Section		2. BENT PIPE					
a. Single direction bending	Indicated lengths of pipe on drawing	$l$ & $l_1$					
	Length tolerance	$d$		$\pm 6$	Not Defined		
	Length tolerance	$d_1$		$\pm 5$	Not Defined		
	Design bending angle	$a^\circ$					
	Bend tolerance	$a_1^\circ$		$\pm 1^\circ$	Not Defined		
b. Two direction bending	Indicated lengths of pipe on drawing	$l, l_1, l_2$					
	Length tolerance	$d$		$\pm 6$	Not Defined		
	Length tolerance	$d_1$		$\pm 5$	Not Defined		
	Length tolerance	$d_2$		$\pm 6$	Not Defined		
	Design bending angles	$a^\circ, a_1^\circ, a_2^\circ$		$\pm 2^\circ$	Not Defined		
c. Three direction bending	Indicated lengths of pipe on drawing	$l, l_1, l_2$					
	Length tolerance	$d$		$\pm 5$	Not Defined		
	Length tolerance	$d_1$		$\pm 5$	Not Defined		
	Length tolerance	$d_2$		$\pm 5$	Not Defined		
	Design bending angles	$a^\circ, a_1^\circ, a_2^\circ$		$\pm 1^\circ$	Not Defined		
Bend tolerance	$a_1^\circ$						
Section		3. Branch pipe					
	Indicated lengths of pipe on drawing	$l, l_1, l_2$					
	Length tolerance	$d$		$\pm 5$	Not Defined		
	Length tolerance	$d_1$		$\pm 5$	Not Defined		
	Length tolerance	$d_2$		$\pm 5$	Not Defined		
	Design angle	$a^\circ$					
	Angle tolerance	$a_1^\circ$	$\pm 1^\circ$	Not Defined			

FIG. A2.1 Piping

I. PIPING

Division		A. PIPE FABRICATION		SHIPBUILDING QUALITY STANDARD			
Section		4. PENETRATION PIECE		Nominal Diameter (mm)	Standard Range (mm)	Tolerance Limits (mm)	Remarks
Sub-section	Item		Figure				
	Indicated lengths of pipe on drawing	$l, l_1$					
	Length tolerance	$d$		$\pm 4$	Not Defined		
	Length tolerance	$d_1$		$\pm 4$	Not Defined		
	Design penetration angle	$a^\circ$					
	Angle tolerance	$a_1^\circ$		$\pm 1^\circ$	Not Defined		
Section		5. FLANGES		Nominal Diameter (mm)	Standard Range (mm)	Tolerance Limits (mm)	Remarks
Sub-section	Item		Figure				
a.	Angle of flange to pipe	$d$		$< 150$ $\geq 150$	$a^\circ \leq 1^\circ$ $d^\circ \leq 1.5^\circ$		
	Angle deviation from normal	$a^\circ$					
b.	Distortion of flange face	$d$		$< 200$ $200-450$ $> 500$	$\leq 0.5$ $\leq 1.0$ $\leq 1.5$	$< 1.0$ $< 2.0$ $< 2.5$	
c.	Distance between fillet and butt welding bead	$d$					
d.	Attachment of flange to pipe	$d$		$t + 1.5$	Not Defined		
	Toe of weld setback from face of flange	$d_1$					
e.	Thread extension past nut	$d$				0-3 threads	
f.	Distance between pipe and bending area	$l$		$> t$	$\geq 2d$		
	Thickness of flange	$t$					
	Bend radius	$r$					
	Pipe diameter	$d$					
g.	Alignment of flanges	$a$		$a \leq 3$ $c - b \leq 3$			
	Maximum distance between flange faces	$c$					
	Minimum distance between flange faces	$b$					

FIG. A2.2 Piping

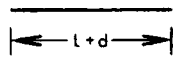
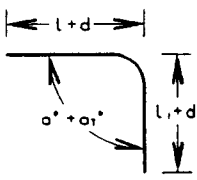
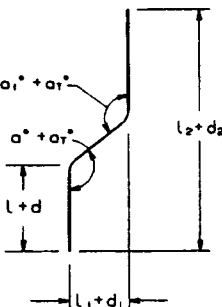
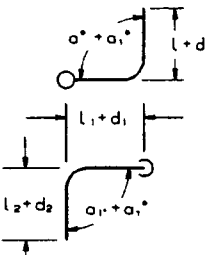
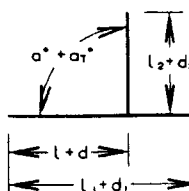
I. PIPING							
Division A. PIPE FABRICATION				SHIPBUILDING QUALITY STANDARDS			
Section 6. COUPLINGS							
Sub-section	Item		Figure	Nominal Diameter (mm)	Standard Range (mm)	Tolerance Limits (mm)	Remarks
a. Coupling (sleeve)	Length of coupling	L			≥3t	not defined	l <sub>1</sub> & a vary according to pipe diameter
	Length of pipe inside coupling	l <sub>1</sub>					
	Distance between pipes inside coupling	l <sub>2</sub>					
	Pipe thickness	t					
	Distance between inside of coupling and outside of pipe	d					
b. Coupling misalignment	Distance between inside of coupling and outside of pipe	d			≤2.0		
	Angle misalignment	a°					
c. Coupling bell & socket	Distance between inside of coupling and outside of pipe	d			≤0.2		
	Distance pipe inserted in socket	l					
	Pipe thickness	t					
d. Dresser coupling distance between pipe ends	Distance between pipe ends	d			±10	not defined	
e. Dresser coupling pipe misalignment	Amount of misalignment	d			±3	±5	
Division B. PIPE BENDING							
Section I. ELLIPTICITY (out of roundness)							
Sub-section	Item	Figure	Tolerance Limits (unit: %)				
			Bending Radius	Cold Bending	Hot Bending	Remarks	
a. Steel and non-ferrous pipe	Ellipticity = $\frac{(D_1 - D_2)}{D} \times 100$ (%) Outside dia. of pipe before manufacturing Major dia. of bent pipe Minor dia. of bent pipe Nominal dia. Bending radius		RS2A 2A<RS3A 3A<RS4A 4A<R	- 10 10 10	10 8 8 5	Tolerance limits of cold bending includes that of high frequency induction heating bending  Standard range not defined	

FIG. A2.3 Piping

I. PIPING							
Division		B. PIPE BENDING		SHIPBUILDING QUALITY STANDARDS			
Section		1. ELLIPTICITY (out of roundness)		Tolerance Limits (units: %)			
Sub-section	Item	Figure	Bending Radius	Cold Bending	Hot Bending	Remarks	
b. Al-brass & CuNi pipe	Ellipticity = $\frac{(D_1 - D_2)}{D} \times 100$ (%)		RS2A	15		Tolerance limits of cold bending includes that of high frequency induction heating bending  Standard range not defined	
	Outside dia. of pipe before manufacturing		D	2A<RS3A	10		
	Major dia. of bent pipe		D <sub>1</sub>	3A<RS4A	10		
	Minor dia. of bent pipe		D <sub>2</sub>	4A<R	8		
	Nominal dia.		A				
Bending radius	R						
Section		2. REDUCTION IN WALL THICKNESS		Tolerance Limits (units: %)			
a. Steel pipe	Reduction in wall thickness = $\frac{(t - t_1)}{t} \times 100$ (%)		RS2A	-	20	Tolerance limits of cold bending includes that of high frequency induction heating bending  Standard range not defined	
	Original wall thickness		t	2A<RS3A	25		10
	Wall thickness after bending		t <sub>1</sub>	3A<RS4A	20		5
	Nominal dia.		A	4A<R	15		5
	Bending radius		R				
b. Copper pipe			RS2A	-	20	Tolerance limits of cold bending includes that of high frequency induction heating bending  Standard range not defined	
			2A<RS3A	30	15		
			3A<RS4A	25	10		
			4A<R	20	10		
c. Al-brass & CuNi pipe			RS2A	25		Tolerance limits of cold bending includes that of high frequency induction heating bending  Standard range not defined	
			2A<RS3A	25			
			3A<RS4A	20			
			4A<R	15			
Section		3. SWELL & WRINKLE DISTORTION		Tolerance Limits (units: %)			
a. All pipe materials	Amount of swell distortion	h			h or h <sub>1</sub> $\leq \frac{1}{100}A$		Tolerance limits not defined
	Amount of wrinkle distortion	h <sub>1</sub>					
	Nominal dia.	A					

FIG. A2.4 Piping

I. PIPING						
Division C. PIPE HANGERS			SHIPBUILDING QUALITY STANDARDS			
Section 1. U-BOLT			unit: mm			
Sub-section	Item	Figure	Standard Range	Tolerance Limits	Remarks	
a. Height difference between ends of U-bolt	Diameter of u-bolt Difference between bolt ends		$Sd/2$	not defined		
b. Pitch of U-bolt	Difference between required and actual location		$\pm 2$	not defined		
c. Clearance between pipe & U-bolt or flat steel band	Clearance between top of pipe & hanger Clearance between bottom of pipe & hanger Clearance between side of pipe & hanger		$\geq 3$	not defined	Applied to necessary part only	
d. Thread extension from nut for U-bolt or flat steel band	Length of thread protusion beyond nut Diameter of bolt		0~5 threads	not defined		
Section 2. FLAT STEEL BAND						
a. Hanger height	Required height of hanger Dimensional variation		-2~0	not defined		
b. Pitch of bolt holes	Required pitch between bolt holes Dimensional variation		$\pm 2$	not defined		
Section 3. DISTANCE BETWEEN PIPE HANGERS						
			Pipe nominal diameter	Maximun hanger spacing	Pipe nominal diameter	Maximun hanger spacing
			10	1.4 m	125	4.5 m
			15	1.6 m	150	5.0 m
			20	1.8 m	200	5.0 m
			25	2.1 m	250	5.5 m
			32	2.4 m	300	6.0 m
			40	2.6 m	350	6.0 m
			50	2.8 m	400	6.0 m
			65	3.2 m	500	7.0 m
			80	3.5 m	600	7.0 m
			100	4.0 m	700	7.0 m

FIG. A2.5 Piping



I. PIPING

Division E. REACH RODS			SHIPBUILDING QUALITY STANDARDS		
Section 1. MANUFACTURING OF REACH ROD			Standard Range	Tolerance Limits	Remarks
Sub-section	Item	Figure	unit: mm		
a.	Diameter of reach rod	D	D $\geq$ 25	not defined	
	Clearance between reach rod and bearing	a	0.5 $\leq$ a $\leq$ 1.5	not defined	
b.	Clearance between reach rod & bearing	a	D $\geq$ 32	not defined	
	Deflection of rod (per 5 m length)	a	0.5 $\leq$ a $\leq$ 2.0	not defined	
b.	Deflection of rod (per 5 m length)	a	$\leq$ 10	not defined	
c.	Clearance between reach rod and joint piece	a	0.2 $\leq$ a $\leq$ 1.0	not defined	
Section 2. FITTING OF REACH ROD					
a.	Spindle end spacing	a	$\leq$ 10	not defined	
	Free end spacing of taper pin	b	5 $\leq$ b $\leq$ 8	not defined	
b.	Deflection of rod (per 5 m length)	a	$\leq$ 10	not defined	
c.	Misalignment between valve spindle and reach rod	a	$\leq$ 10	not defined	
d.	Angle deviation from vertical	a°	$\leq$ 1°	not defined	
e.	Angle deviation from normal	a°	$\leq$ 1°	not defined	

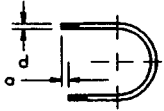
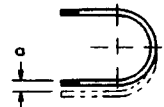
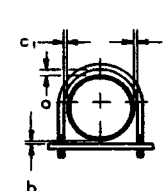
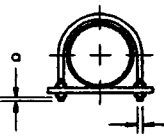
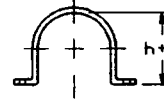
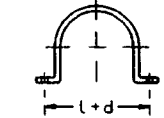
FIG. A2.6 Piping

I. PIPING							
Division F. BELLMOUTHS				SHIPBUILDING QUALITY STANDARDS			
Section 1. A-TYPE BELLMOUTH							
Sub-section	Item		Figure	Nominal Diameter (mm)	Standard Range (mm)	Tolerance Limits (mm)	Remarks
	Height of bellmouth above bottom of tank	l		80	l = 15		
	Height tolerances	d		100	l = 20		
				125	l = 20		
				150	l = 25		
				200	l = 35		
Section 2. B-TYPE BELLMOUTH							
	Height of bellmouth above bottom of tank	l		250	l = 50		
	Height tolerances	d		300	l = 50		
				350	l = 80		
				400	l = 80		
				450	l = 100		
				500	l = 100		
				550	l = 120		
Section 3. C-TYPE BELLMOUTH							
	Height of bellmouth above bottom of tank	l		40	l = 15		
				50	l = 15		
				65	l = 20		
				80	l = 25		
				100	l = 35		
				125	l = 40		
				150	l = 45		
				200	l = 65		

FIG. A2.7 Piping

I. HULL OUTFITTING						
Division I-A WATER TIGHT STEEL HATCH COVER				SHIPBUILDING QUALITY STANDARDS		
Section I. HATCH COVER (SINGLE PULL TYPE)						
Sub-section	Item	Figure	Standard Range (mm)	Tolerance Limits (mm)	Remarks	
1. Dimension of hatch cover	Length (1 hatch)	$\delta_1$ ①		Not Defined Not Defined Not Defined Not Defined Not Defined Not Defined	① and ② indicate acceptable tolerances for various support conditions shown below: ①: condition where each cover is ranged without closely tightening ②: condition where each cover is ranged and tightened L = designed dimension L <sub>1</sub> = actual dimension	
	Length (1 panel)	$\delta_2$				$\pm 3$
	Breath	$\delta_3$ ①				$\pm 3$
	Height of hatch cover	$\delta_4$				$\pm 3$
	Difference between diagonals (1 hatch)	$ L_1 - L_2 $ ①				$\leq 5$
	Difference between diagonals (1 panel)	$ L_1 - L_2 $				$\leq 4$
2. Deflection of side end and top plate	Deflection of side plate in the vertical direction	$\delta_6$		Not Defined Not Defined Not Defined Not Defined Not Defined Not Defined	*indicates clearance between under-surface of cover and surface table when putting on the surface table	
	Deflection of end plate in the vertical direction	$\delta_7$				$\pm 3$
	Bend of side plate in the transverse direction	$\delta_8$				$\pm 3$
	Bend of end plate in the transverse direction	$\delta_9$				$\pm 3$
	Deformation of top plate	$\delta_{10}$				$\pm 4$
	*Flatness of undersurface of hatch cover (1 panel)					$\leq 3$
3. Dimension of wheel after installing	Dimension of balancing wheel after installing	$\delta_{11}$		$\pm 2$ $\pm 2$ $\pm 2$ $\pm 2$ $\pm 2$	$\pm 3$ $\pm 3$ $\pm 3$ $\pm 3$ $\pm 4$	
	Height of balancing wheel	$\delta_{12}$				
	Dimension of wheel after installing	$\delta_{13}$				
	Height of wheel	$\delta_{14}$				
	Pitch of installed wheel	$\delta_{15}$ ①				

FIG. A2.8 Hull Outfitting

I. HULL OUTFITTING						
Division I-A WATER TIGHT STEEL HATCH COVER				SHIPBUILDING QUALITY STANDARDS		
Section 1. HATCH COVER (SINGLE PULL TYPE)						
Sub-section	Item		Figure	Standard Range (mm)	Tolerance Limits (mm)	Remarks
4. Intermediate hinge and water tightness	Height from base line to packing gutter	$\delta_{16}$		$\pm 1$	$\pm 2$	$t$ =thickness of compression bar
	Breath of packing gutter	$\delta_{18}$		$\pm 1$	$\pm 2$	Compressed depth of packing surrounding hatch cover to be in accordance with this item.
	Deviation between compression bar and packing	$\delta_{19}$		$\pm 5$	$\pm \frac{1}{2}$	* not defined
	Compressed depth of packing	$\delta_{20}$		$\pm 3$	*	* not defined
	Deviation between top plates	$\delta_{21}$		$\leq 2$	$\leq 4$	
	Deviation between side plates	$\delta_{22}$		$\leq 2$	$\leq 4$	
	Clearance between hatch covers	$\delta_{23}$	 SECT A-A	$\pm 3$	$-5$ - $+10$	
5. Installing position of snag for quick acting cleat	Longitudinal deviation	$\delta_{24}$		$\pm 4$	$\pm 6$	
	Vertical deviation	$\delta_{25}$		$\pm 4$	$\pm 6$	
6. Clearance between hatch cover and hatch coaming	Touchpiece type	$\delta_{26}$		$\leq 1$	$\leq 2$	Refer to note
	Directly of touched type	$\delta_{27}$		$\leq 3$	$\leq 5$	
	Rest pad type	$\delta_{28}$		$\leq 1$	$\leq 2$	
<p>Note</p> <p>Every touchpiece of A or C type to be in touch with end and side girder of hatch cover or rest arm of hatch cover.</p> <p>For type B, end and side girder of hatch cover to be in touch with the coaming top plate at least one position in any 3 meters.</p>						
Section 2. HATCH COVER (SINGLE PULL TYPE)						
1. Dimension of hatch coaming	•Length	$\delta_1$		$\pm 5$	$\pm 10$	* to be in accordance with hull specification. L=designed dimension L <sub>1</sub> =actual dimension
	•Breadth	$\delta_2$		$\pm 5$	$\pm 10$	
	•Difference between diagonals	$ L_1-L_2 $		$\leq 10$	$\leq 15$	

FIG. A2.9 Hull Outfitting



I. HULL OUTFITTING						
Division		I-A WATER TIGHT STEEL HATCH COVER			SHIPBUILDING QUALITY STANDARDS	
Section		2. HATCH COAMINGS (SINGLE PULL TYPE)				
Sub-section	Item	Figure	Standard Range (mm)	Tolerance Limits (mm)	Remarks	
2. Deflection of horizontal stiffener (installing position of compression bar)	* End coaming	$\delta_3$		$\pm 3$	$\pm 5$	* to be in accordance with hull specification.
	* Side coaming	$\delta_4$		$\pm 5$	$\pm 8$	
	* Deflection in any one meter (at end and side coaming)	$\delta_5$		$\pm 2$	$\pm 3$	
3. Installing dimension of compression bar	Installing position	$\delta_6$		$\pm 3$	$\pm 5$	t = thickness of compression bar
	Longitudinal deviation	$\delta_7$		$\pm 3$	$\pm 8$	
	Transverse deviation	$\delta_8$		$\leq 3$	$\pm 5$	
4. Installing dimension of guide rail and ramp	Deviation from center line of cover packing	$\delta_9$		$\leq 5$	$\pm \frac{1}{2}$	
	Installing position of guide rail	$\delta_{10}$		$\pm 3$	$\pm 3$	
	Installing position of ramp	$\delta_{11}$		$\pm 3$	$\pm 3$	
	Deviation of ramp from vertical line	$\delta_{12}$		$\pm 3$	$\pm 3$	
Section		3. HATCH COAMINGS (SIDE ROLLING TYPE)				
1. Dimension of hatch cover	Length	$\delta_1$ ①		$\pm 5$	Not Defined	① and ② indicate acceptable tolerances for various support conditions shown below: ①: condition where each cover is ranged without closely tightening ②: condition where each cover is ranged and tightened L = designed dimension L <sub>1</sub> = actual dimension
	Breadth (1 hatch)	$\delta_2$ ①		$\pm 5$	Not Defined	
	Breadth (1 panel)	$\delta_3$		$\pm 4$	Not Defined	
	Height of cover	$\delta_{4,5}$		$\pm 3$	Not Defined	
	Difference between diagonals (1 panel)	$ L_1 - L_2 $ ①		$\leq 5$	Not Defined	
	Difference between diagonals (1 panel)	$ L_3 - L_4 $		$\leq 4$	Not Defined	
2. Deflection of side, end and top plate	Deflection of side plate in the vertical direction	$\delta_6$		$\pm 3$	Not Defined	* indicates clearance between under surface of hatch cover and surface table, when putting on the surface table.
	Deflection of end plate in the vertical direction	$\delta_7$		$\pm 3$	Not Defined	
	Bend of side plate in the transverse direction	$\delta_8$		$\pm 3$	Not Defined	
	Bend of end plate in the transverse direction	$\delta_9$		$\pm 3$	Not Defined	
	Deformation of top plate	$\delta_{10}$		$\pm 4$	Not Defined	
	* Flatness of lower surface of hatch cover (1 panel)			$\leq 3$	Not Defined	

FIG. A2.10 Hull Outfitting

I. HULL OUTFITTING						
Division I-A WATER TIGHT STEEL HATCH COVER				SHIPBUILDING QUALITY STANDARDS		
SECTION 3. HATCH COVER (SIDE ROLLING TYPE)				Standard Range (mm)	Tolerance Limits (mm)	Remarks
Sub-section	Item		Figure			
3. Installing dimension of wheel	Span (between center lines)	$\delta_{11}$		$\pm 2$	$\pm 3$	
	Installing height	$\delta_{12}$		$\pm 2$	$\pm 3$	
	Installing pitch	$\delta_{13}$		$\pm 2$	$\pm 3$	
4. Intermediate hinge and watertight construction	Height from base line to packing gutter	$\delta_{14}$		$\pm 1$	$\pm 2$	t=thickness of compression bar Compressed depth of packing, surrounding hatch cover to be in accordance with this item. * not defined
	Breath of packing gutter	$\delta_{15}$		$\pm 1$	$\pm 2$	
	Deviation between compression bar and packing	$\delta_{16}$		$\leq 5$	$\pm 2$	
	Compressed depth of parking	$\delta_{17}$		$\leq 3$	*	
	Deviation between top plates	$\delta_{18}$		$\pm 2$	$\leq 4$	
	Deviation between end plates	$\delta_{19}$		$\pm 3$	$\leq 4$	
	Clearance between hatch covers	$\delta_{20}$		$\pm 3$	$-5 \rightarrow +10$	
5. Installing position of snag for quick acting cleat	Longitudinal deviation	$\delta_{22}$		$\pm 4$	$\pm 6$	
	Vertical deviation	$\delta_{23}$		$\pm 4$	$\pm 6$	
6. Clearance between hatch cover and hatch coaming	Touch piece type	$\delta_{24}$		$\leq 1$	$\leq 2$	Refer to note
	Directly touched type	$\delta_{25}$		$\leq 3$	$\leq 5$	
	Rest pad type	$\delta_{26}$		$\leq 1$	$\leq 2$	
Note Every touchpiece of A or C type to be in touch with end and side girder of hatch cover or rest arm of hatch cover. For type B, end and side girder of hatch cover to be in touch with the coaming. top plate at least one position in any 3 meters.						
SECTION 4. HATCH COAMING (SIDE ROLLING TYPE)						
1. Dimension of hatch coaming	*Length	$\delta_1$		$\pm 5$	$\pm 10$	* to be in accordance with hull specification. l=designed dimension L=actual dimension
	*Breadth	$\delta_2$		$\pm 5$	$\pm 10$	
	*Difference between diagonals	$ L_1 - L_2 $		$\leq 10$	$\leq 15$	

FIG. A2.11 Hull Outfitting

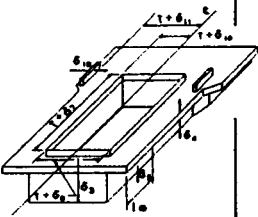
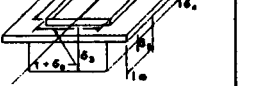
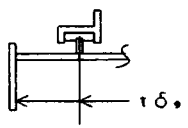
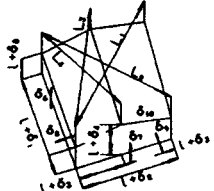
I. HULL OUTFITTING						
Division I-A WATER TIGHT STEEL HATCH COVER				SHIPBUILDING QUALITY STANDARDS		
Section 4. HATCH COAMINGS (SIDE ROLLING TYPE)						
Sub-section	Item	Figure	Standard Range (mm)	Tolerance Limits (mm)	Remarks	
2. Deflection of horizontal stiffener (at installing position of compression bar)	• End coaming	$\delta_3$	$\pm 3$	$\pm 5$	* to be in accordance with hull specification. l = Design dimension	
	• Side coaming	$\delta_4$	$\pm 5$	$\pm 8$		
	• Deflection in any one meter (at end and side coaming)	$\delta_5$	$\pm 2$	$\pm 3$		
3. Installing dimension of compression bar	Installing position	$\delta_6$	$\pm 3$	$\pm 5$	t = thickness of compression bar	
	Longitudinal and transverse deviation	$\delta_7$	$\pm 3$	$\pm 5$		
	Deviation from center line of cover packing	$\delta_8$	$\pm 5$	$\pm \frac{1}{2}$		
4. Installing dimension of rail	Installing position of rail	$\delta_9$	$\pm 3$	$\pm 5$		
	Level of rail top	$\delta_{10}$	$\pm 3$	$\pm 5$		
5. Position of opening hole of jack	Deviation between wheel center and jack center	$\delta_{11}$	$\pm 3$	$\pm 5$		
	Deviation between rail and flap	$\delta_{12}$	$\pm 1$	$\pm 2$		
Section 5. HATCH COVER (PONTOON TYPE FOR CONTAINER SHIP)						
1. Dimension of hatch cover	Length	$\delta_1$	$\pm 5$	•	① and ② indicate acceptable tolerances for various support conditions shown follows: ① : condition putting together, nontight; ② : closed condition l = Design dimension	
	Breadth	$\delta_2$	$\pm 5$	•		
	Height of cover	$\delta_3$	$\pm 3$	•		
	Difference between diagonals	$ L_1 - L_2 $	$\leq 5$	•		
2. Deflection of side, end and top plate	Deflection of side plate in the direction of up and down	$\delta_4$	$\pm 3$	•	L = actual dimension to be measured by condition 2 at container mount on cover or pedestal. * not defined	
	Deflection of end plate in the direction of up and down	$\delta_5$	$\pm 3$	•		
	Bend of side plate in the direction of transverse	$\delta_6$	$\pm 3$	•		
	Bend of end plate in the direction of transverse	$\delta_7$	$\pm 3$	•		
	Deformation of top plate	$\delta_8$	$\pm 4$	•		
Flatness of under surface of cover			$\leq 3$	•		

FIG. A2.12 Hull Outfitting

I. HULL OUTFITTING						
Division I-A WATER TIGHT STEEL HATCH COVER				SHIPBUILDING QUALITY STANDARDS		
Section 5. HATCH COVER (PONTOON TYPE FOR CONTAINER SHIP)						
Sub-section	Item		Figure	Standard Range (mm)	Tolerance Limits (mm)	Remarks
3. Water tightness	Height from base line to packing gutter	$\delta_9$ $\delta_{10}$		$\pm 1$ $\pm 1$	$\pm 2$ $\pm 2$	
	Breadth of packing gutter	$\delta_{11}$			$\pm 1$	$\pm 2$
4. Clearance between hatch cover and hatch coaming	Touch piece type	$\delta_{12}$		$\leq 1$	$\leq 2$	Refer to note
	Directly touched type	$\delta_{13}$		$\leq 3$	$\leq 5$	
	Rest pad type	$\delta_{14}$		$\leq 1$	$\leq 2$	
<p>Note</p> <p>Every touchpiece of A or C type to be in touch with end and side girder of hatch cover or rest arm of hatch cover.</p> <p>For type B, end and side girder of hatch cover to be in touch with the coaming top plate at least one position in any 3 meters.</p>						
Section 6. HATCH COAMING (PONTOON TYPE FOR CONTAINER SHIP)						
1. Dimension of hatch cover	*Length	$\delta_1$		$\pm 5$	$\pm 10$	* to be in accordance with hull specification.
	*Breadth	$\delta_2$		$\pm 5$	$\pm 10$	
	*Difference between diagonals	$ L_1-L_2 $		$\leq 5$	$\leq 15$	
2. Deflection of horizontal stiffener (at installing position of compression bar)	*End coaming	$\delta_3$		$\pm 3$	$\pm 5$	
	*Side coaming	$\delta_4$		$\pm 5$	$\pm 8$	
	*Deflection in any one meter (at end and side coaming)	$\delta_5$		$\pm 2$	$\pm 3$	
3. Installing dimension of compression bar	*Installing position	$\delta_6$		$\pm 3$	$\pm 5$	t=thickness of compression bar
	*Longitudinal and transverse deviation	$\delta_7$		$\pm 3$	$\pm 5$	
	*Deviation from center line of cover packing	$\delta_8$		$\pm 5$	$\pm \frac{1}{2}$	

FIG. A2.13 Hull Outfitting





I. HULL OUTFITTING						
Division		I-A WATER TIGHT STEEL HATCH COVER			SHIPBUILDING QUALITY STANDARDS	
Section		1. HATCH COVER (FOLDING TYPE)				
Sub-section	Item	Figure	Standard Range (mm)	Tolerance Limits (mm)	Remarks	
1. Dimension of hatch cover	Length (1 hatch)	$\delta_1$ ①	$\pm 5$	Not Defined	① and ② indicate acceptable tolerances for various support conditions shown below: ①: condition where each cover is ranged without closely tightening ②: condition where each cover is ranged and tightened	
	Length (1 panel)	$\delta_2$	$\pm 3$			
	Breath	$\delta_3$ ①	$\pm 3$			
	Height of hatch cover	$\delta_4$	$\pm 3$			
	Difference between diagonals (1 hatch)	$ L_1 - L_2 $ ①	$\leq 5$			
	Difference between diagonals (1 panel)	$ L_1 - L_2 $	$\leq 4$			
2. Deflection of side end and top plate	Deflection of side plate in the vertical direction	$\delta_5$	$\pm 3$	↓	L = designed dimension L <sub>1</sub> = actual dimension * indicates clearance between under-surface of cover and surface table when putting on the surface table	
	Deflection of end plate in the vertical direction	$\delta_6$	$\pm 3$			
	Bend of side plate in the transverse direction	$\delta_7$	$\pm 3$			
	Bend of end plate in the direction of transverse	$\delta_8$	$\pm 3$			
	Deformation of top plate	$\delta_9$	$\pm 4$			
	*Flatness of transverse under surface of hatch cover (1 panel)		$\leq 3$			
3. Installing dimension of wheel	Span (between center lines)	$\delta_{10}$	$\pm 2$	$\pm 3$		
	Installing height	$\delta_{11}$	$\pm 2$	$\pm 3$		
	Installing pitch	$\delta_{12}$	$\pm 2$	$\pm 4$		
4. Intermediate hinge and water tightness	Height from base line to packing gutter	$\delta_{13}$	$\pm 1$	$\pm 2$	$t$ = thickness of compression bar Compressed depth of packing surrounding hatch cover to be in accordance with this item. * not defined	
		$\delta_{14}$	$\pm 1$	$\pm 2$		
	Breath of packing gutter	$\delta_{15}$	$\pm 1$	$\pm 2$		
	Deviation between compression bar and packing	$\delta_{16}$	$\pm 5$	$\pm \frac{1}{2}$		
	Compressed depth of packing	$\delta_{17}$ ②	$\pm 2$	*		
	Deviation between top plates	$\delta_{18}$ ②	$\leq 2$	$\leq 4$		
	Deviation between side plates	$\delta_{19}$ ②	$\leq 2$	$\leq 4$		
	Clearance between hatch covers	$\delta_{20}$ ②	$\pm 3$	$-5 \rightarrow +10$		

FIG. A2.14 Hull Outfitting

I. HULL OUTFITTING						
Division I-A WATER TIGHT STEEL HATCH COVER				SHIPBUILDING QUALITY STANDARDS		
Section I. HATCH COVER (FOLDING TYPE)						
Sub-section	Item		Figure	Standard Range (mm)	Tolerance Limits (mm)	Remarks
5. Installing position of snag for quick acting cleat	Longitudinal deviation	$\delta_{21}$		$\pm 4$	$\pm 6$	
	Vertical deviation	$\delta_{22}$		$\pm 4$	$\pm 6$	
6. Clearance between hatch cover and hatch coaming	Touchpiece type	$\delta_{23}$		$\leq 1$	$\leq 2$	Refer to note
	Directly of touched type	$\delta_{24}$		$\leq 3$	$\leq 5$	
	Rest pad type	$\delta_{25}$		$\leq 1$	$\leq 2$	
<p>Note</p> <p>Every touchpiece of a A or C type to be in touch with end end and side girder of hatch cover or rest arm of hatch cover.</p> <p>For type B, end and side girder of hatch cover to be in touch with the coaming top plate at least one position in any 3 meters.</p>						
7. Installing dimension of intermediate and main hinge	Deviation between main hinge and baseline of hatch cover (longitudinal and vertical direction)	$\delta_{26}$		$\pm 2$	$\pm 3$	
	Deviation between main hinge and baseline of hatch cover (longitudinal and vertical direction)	$\delta_{27}$		$\pm 2$	$\pm 3$	
8. Installing dimension of intermediate and main hinge	Deviation between eye plate for main cylinder and base line of hatch cover	$\delta_{28}$		$\pm 2$	$\pm 3$	
Section 2. HATCH COVER (FOLDING TYPE)						
1. Dimension of hatch coaming	*Length	$\delta_1$		$\pm 5$	$\pm 10$	* to be in accordance with hull specification. L=designed dimension L1=actual dimension
	*Breadth	$\delta_2$		$\pm 5$	$\pm 10$	
	*Difference between diagonals	$ L_1-L_2 $		$\leq 10$	$\leq 15$	

FIG. A2.15 Hull Outfitting

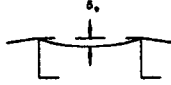
I. HULL OUTFITTING						
Division I-A WATER TIGHT STEEL HATCH COVER				SHIPBUILDING QUALITY STANDARDS		
Section 2. HATCH COAMINGS (FOLDING TYPE)				Standard Range (mm)	Tolerance Limits (mm)	Remarks
Sub-section	Item	Figure				
2. Deflection of horizontal stiffener (installing position of compression bar)	• End coaming	$\delta_3$		$\pm 3$	$\pm 5$	* to be in accordance with hull specification. l = designed dimension t = thickness of compression bar
	• Side coaming	$\delta_4$		$\pm 5$	$\pm 8$	
	• Deflection in any one meter (at end and side coaming)	$\delta_5$		$\pm 2$	$\pm 3$	
3. Installing dimension of compression bar	Installing position	$\delta_6$		$\pm 3$	$\pm 5$	
	Longitudinal deviation	$\delta_7$		$\pm 3$	$\pm 8$	
	Transverse deviation	$\delta_8$		$\pm 3$	$\pm 5$	
4. Installing dimension of guide rail	Deviation from center line of cover packing	$\delta_9$		$\pm 5$	$\pm \frac{1}{2}$	
	Installing position of rail	$\delta_{10}$		$\pm 3$	$\pm 5$	
	Deviation of ramp from vertical line	$\delta_{11}$		$\pm 3$	$\pm 5$	
Division I-B ENTRANCE DOOR AND HATCH						
Section 1. WATER TIGHT STEEL DOOR						
1. Door	Breadth	$\delta_1$		$\pm 2$	$\pm 4$	l = designed dimension $\delta_3$ : distance between middle points of diagonals
	Height	$\delta_2$		$\pm 2$	$\pm 4$	
	Distortion	$\delta_3$		$\pm 2$	$\pm 3$	
	Straightness	$\delta_4$		$\pm 1$	$\pm 3$	
	Warp	$\delta_5$		$\pm 1$	$\pm 3$	
2. Door coaming	Breadth	$\delta_6$		$\pm 2$	$\pm 4$	$\delta_9$ : distance between middle points of diagonals
	Height	$\delta_7$		$\pm 2$	$\pm 4$	
	Height of sill	$\delta_8$		0-15	0-30	
	Distortion	$\delta_9$		$\pm 2$	$\pm 4$	
	Straightness	$\delta_{10}$		$\pm 1$	$\pm 3$	
	Warp	$\delta_{11}$		$\pm 1$	$\pm 3$	
3. Part of cut steel wall	Breadth	$\delta_{12}$		$\pm 4$	$\pm 7$	
	Height	$\delta_{13}$		$\pm 4$	$\pm 7$	
	Height of sill	$\delta_{14}$		0-15	-10-30	
	Defromation	$\delta_{15}$		$\pm 2$	$\pm 3$	

FIG. A2.16 Hull Outfitting

I. HULL OUTFITTING				SHIPBUILDING QUALITY STANDARDS		
Division I-B ENTRANCE DOOR AND HATCH						
Section 2. WATER TIGHT STEEL SMALL HATCH (SQUARE TYPE)						
Sub-section	Item		Figure	Standard Range (mm)	Tolerance Limits (mm)	Remarks
1. Hatch cover	Breadth	$\delta_1$		$\pm 3$	$\pm 5$	$\delta_3$ : distance between middle points of diagonals
	Length	$\delta_2$		$\pm 3$	$\pm 5$	
	Distortion	$\delta_3$		$\pm 2$	$\pm 3$	
	Straightness	$\delta_4$		$\pm 1$	$\pm 3$	
	Deformation (in any one meter)	$\delta_5$		$\pm 1$	$\pm 3$	
2. Hatch coaming	Breadth	$\delta_6$		$\pm 2$	$\pm 5$	$\delta_9$ : distance between middle points of diagonals
	Length	$\delta_7$		$\pm 2$	$\pm 5$	
	Height	$\delta_8$		0 - 6	0 - 20	
	Distortion	$\delta_9$		$\pm 2$	$\pm 3$	
	Straightness	$\delta_{10}$		$\pm 1$	$\pm 3$	
3. Part of cut deck plate (penetration type)	Breadth	$\delta_{11}$		$\pm 2$	$\pm 3$	
	Length	$\delta_{12}$		$\pm 2$	$\pm 3$	
4. Part of cut deck plate (non-penetration type)	Breadth	$\delta_{11}$		-3 ~ 2	-5 ~ 3	
	Length	$\delta_{12}$		-3 ~ 2	-5 ~ 3	
5. Water tightness	Touch between gasket and coaming			$B \geq \frac{1}{2}$		<p>To be applied for steel water tight door and water tight steel small hatch.</p> <p>(Water tight door)                      B: Breadth of chalk clung on the gasket after tightening test. The test is to be carried out with thrusting chips to the middle of the wedges.</p> <p>(Water tight small hatch)                      B: Breadth of chalk clung on the gasket after tightening test. The test is to be carried out with thrusting chips to the middle of the wedges.</p>
Section 3. WATER TIGHT STEEL SMALL HATCH (ROUND TYPE)				TO BE IN ACCORDANCE WITH THE WATER TIGHT SQUARE SMALL HATCH NOTE: REGARDING A DIAMETER AS LENGTH OR BREADTH		

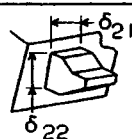
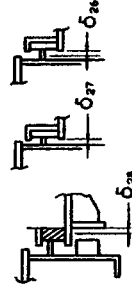
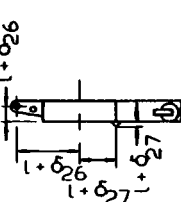
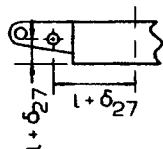
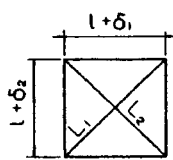
FIG. A2.17 Hull Outfitting

I. HULL OUTFITTING						
Division I-C VENTILATOR AND SKYLIGHT			SHIPBUILDING QUALITY STANDARDS			
Section I. ANOTHER WATER TIGHT STEEL HATCH						
Sub-section	Item	Figure	Standard Range (mm)	Tolerance Limits (mm)	Remarks	
1. Water tightness	* Contact between gasket and coaming		$B \geq \frac{1}{2}$		Ventilation hole with wall Wall louver Goose neck ventilator Mushroom ventilator	
Section I. SKYLIGHT						
1. Water tightness	Contact between gasket and coaming		$B \geq \frac{1}{2}$			
Division I-D CARGO LOADING APPARATUS						
Section I. WELDING FABRICATED BOOM						
1. Derrick boom	Length	$\delta_1$	$\pm 7$	$\pm 10$	d: designed dimension of derrick boom at measuring position $D_1$ = max diameter $D_2$ = min. diameter	
	Bending	$\delta_2$	$\pm 5$	$\pm 10$		
	Diameter	$\delta_3$	$0 - \frac{D}{100}$	$0 - \frac{20}{100}$		
	Permissible out of roundness of cylindrical shell at installing position of base assemblies	$D_1 - D_2$	$\leq 1$	$\leq 2$		
2. Derrick boom and assemblies	Distortion between assemblies on base and assemblies on top	$\delta_3$	$\leq 1$	$\leq 2$		

FIG. A2.18 Hull Outfitting

I. HULL OUTFITTING						
Division I-E CONTAINER LASHING DEVICES				SHIPBUILDING QUALITY STANDARDS		
Section I. CONTAINER LASHING FITTING						
Sub-section	Item		Figure	Standard Range (mm)	Tolerance Limits (mm)	Remarks
1. 20' Container fitting	Length	$\delta_1$		$\pm 3$	$\pm 4$	① and ② indicate acceptable tolerances for various support conditions shown follows: ① : condition putting together, non-tight. ② : closed condition l = Specified dimension
	Breadth	$\delta_2$		$\pm 2$	$\pm 3$	
	Difference of height at cross section of diagonals	$\delta_3$		2	4	
	Difference between diagonals	$ L_1 - L_2 $		5	8	
2. 40' Container fitting	Length	$\delta_3$		$\pm 3$	$\pm 5$	L <sub>1</sub> = actual dimension to be measured by condition ② at container mount on cover or pedestal.
	Breadth	$\delta_4$		$\pm 2$	$\pm 3$	
	Difference of height at cross section of diagonals	$\delta_5$		2	4	
	Difference between diagonals	$ L_3 - L_4 $		5	8	
3. Clearance between cell guide and container	Length	$\delta_6 + \delta_8$			$\pm 7$	
	Breadth	$\delta_7 + \delta_8$			$\pm 7$	

FIG. A2.19 Hull Outfitting

I. HULL OUTFITTING						
Division I-F MOVABLE DECK, RAMP WAY, ETC.			SHIPBUILDING QUALITY STANDARDS			
Section I HOISTABLE DECK (LIFTABLE DECK)						
Sub-section	Item	Figure	Standard Range (mm)	Tolerance Limits (mm)	Remarks	
1. Dimension of deck	Length	$\delta_1$		$\pm 5$	$\pm 8$	$l =$ designed dimension  $\delta_4, \delta_5:$ actual dimension
	Breadth	$\delta_2$		$\pm 5$	$\pm 8$	
	Height	$\delta_3$		$\pm 3$	$\pm 5$	
	Difference between diagonals	$\delta_4 - \delta_5$		$\pm 8$	$\pm 10$	
2. Distortion of deck	Deflection of deck	$\delta_6$		$+5$ $-0$	$+10$ $-5$	$\delta_7, \delta_8:$ distortion of deck to be kept designed supporting condition.
	Distortion of deck	$\delta_7$ $\delta_8$		$+5$ $-2$	$+10$ $-5$	
	Deviation of deck end from deck level	$\delta_{20}$			5	
3. Clearance between decks	Difference in level between movable decks	$\delta_9$			10	$l =$ designed dimension  $\delta_9, \delta_{10}, \delta_{11}, \delta_{12}:$ difference of level and clearance between decks to be kept designed supporting and guided position.
	Difference in level between movable deck and fixed deck	$\delta_{10}$			10	
	Clearance between movable decks	$\delta_{11}$		$\pm 5$	$\pm 8$	
	Clearance between movable deck and fixed deck	$\delta_{12}$			$\pm 10$	
4. Height between decks	Height between fixed deck and movable deck	$\delta_{13}$		$+20$ $-0$		$l =$ designed dimension  $\pm:$ Planned dimension means the clear height to be kept in the loading condition.
	Height between movable decks	$\delta_{14}$		$+20$ $-0$		
5. Guiderail	Deviation of guiderail from vertical line	$\delta_{15}$		5		$\delta_{15}:$ deviation from vertical line between one deck, spans.
6. Clearance between pillar and movable deck	Deviation of guiderail from vertical line	$\delta_{16}$			$+10$	$l =$ designed dimension
	do	$\delta_{17}$			$\pm 10$	
7. Clearance between guiderail and guide piece	Clearance between guiderail and guide piece	$\delta_{18}$			$+8$ $-0$	
	do	$\delta_{19}$			$+8$ $-0$	

FIG. A2.20 Hull Outfitting

I. HULL OUTFITTING					
Division I-F MOVABLE DECK, RAMP WAY, ETC.				SHIPBUILDING QUALITY STANDARDS	
Section 2 STERN RAMP (INCLUDING RAMP DOOR)					
Sub-section	Item	Figure	Standard Range (mm)	Tolerance Limits (mm)	Remarks
1. Dimension of ramp	Breadth (lower part)	$\delta_1$		$\pm 5$	l = designed dimension CL1 : center of main hinges CL2 : center of interchange CL3 : center of flap hinges CL4 : means the perpendicular to CL1. L + $\delta_3$ = ① + ② L + $\delta_3$ = ③ + ④ + ⑤ $\delta_4, \delta_5$ : to be measured after erection $\delta_{12}, \delta_{13}$ : actual distance
	Breadth (upper part)	$\delta_2$		$\pm 5$	
	Length (SEC I)	$\delta_3$		$\pm 5$	
	Length (SEC II)	$\delta_4$		$\pm 5$	
	Length (TOTAL)	$\delta_5$		$\pm 10$	
2. Position of hinges	Distance between main hinges	$\delta_6$		$\pm 8$	
	Distance between the center of hinges	$\delta_7$		$\pm 8$	
	Distance between inter-hinge	$\delta_8, \delta_9$		$\pm 4, \pm 4$	
3. Dimension of ramp door	Longitudinal distance between compression bars	$\delta_{10}$		$\pm 5$	
	Transverse distance between compression bars	$\delta_{11}$		$\pm 5$	
	Difference between diagonal distances of compression bar	$\delta_{12}, \delta_{13}$		$\pm 8$	
4. Distortion of ramp	Longitudinal distortion	$\delta_{14}$		$\pm 5$	
	Transverse distortion	$\delta_{15}$		$\pm 5$	
5. Clearance etc. in way of tightening part	Deviation of the position of compression bar from the centerline of packing	$\delta_{16}$		$\pm 5$	
	Clearance between the packing glove and the top plate of ramp door	$\delta_{17}$		5	

FIG. A2.21 Hull Outfitting

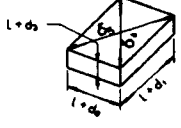
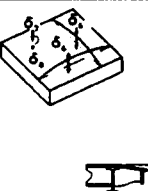
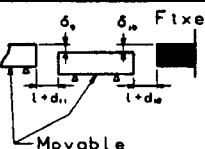
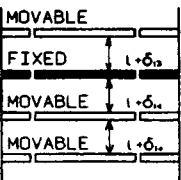
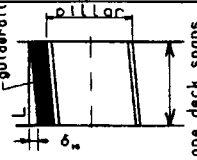
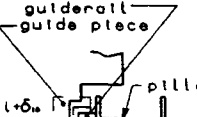
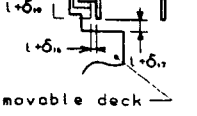

I. HULL OUTFITTING					
Division I-F MOVABLE DECK, RAMP WAY, ETC.				SHIPBUILDING QUALITY STANDARDS	
Section 3 MIDSHIP RAMP (INCLUDING RAMP DOOR)					
Sub-section	Item	Figure	Standard Range (mm)	Tolerance Limits (mm)	Remarks
1. Dimension of ramp	Breadth (lower part)	$\delta_1$	$\pm 5$	$\pm 8$	l = designed dimension CL1 : center of main hinges CL2 : center of flap hinges
	Breadth (upper part)	$\delta_2$	$\pm 5$	$\pm 8$	
	Length (ramp)	$\delta_3$	$\pm 5$	$\pm 8$	
	Length (flap)	$\delta_4$	$\pm 5$	$\pm 8$	
2. Dimension and position of hinges	Distance between main hinges	$\delta_5$		$\pm 5$	
	Breadth of lifting eyes	$\delta_6$		$\pm 2$	
3. Dimension of ramp door	Longitudinal distance between compression bars	$\delta_7$		$\pm 5$	$\delta_9, \delta_{10}$ : actual distance
	Transverse distance between compression bars	$\delta_8$		$\pm 5$	
	Difference between diagonal distances of compression bar	$\delta_9 - \delta_{10}$		$\pm 8$	
4. Distortion of ramp	Longitudinal distortion	$\delta_{11}$		$\pm 5$	
	Transverse distortion	$\delta_{12}$		$\pm 5$	
5. Clearance etc. in way of tightening part	Deviation of the position of compression bar from the centerline of packing part	$\delta_{13}$		$\pm 5$	
	Clearance between the packing glove and the top plate of ramp door	$\delta_{14}$		5	

FIG. A2.22 Hull Outfitting

I. HULL OUTFITTING					
Division I-F MOVABLE DECK, RAMP WAY, ETC.			SHIPBUILDING QUALITY STANDARDS		
Section 4 BULKHEAD DOOR/COAMING					
Sub-section	Item	Figure	Standard Range (mm)	Tolerance Limits (mm)	Remarks
1. Dimension of door	Breadth			±5	l = designed dimension  delta_5, delta_6, delta_11, delta_12: actual dimension
	Height		±5		
	Depth		±3		
	Difference between diagonal distances		±3		
2. Position of fittings	Height of the center line of wheel	±3			
	Position of cleat	±3			
	Position of stopping device	±5			
3. Distortion of door	Distortion (transverse direction)	±3			
	Distortion (vertical direction)	±3			
4. Dimension of coaming	Breadth			±5	l = designed dimension  delta_17, delta_18 delta_20 - delta_23: actual dimension
	Height		±5		
	Depth		±3		
	Difference between diagonal distances		±3		
5. Position of roll	Distance from the bulkhead to the center of gulderall	±8			
		±3			
6. Distortion of coaming	Deflection (transverse direction)			±3	
	Deflection (vertical direction)		±3		
	Distortion (transverse direction)		±3		
	Distortion (vertical direction)		±3		
	Clearance between deck and back plate of door packing			±3	l = designed dimension
	Gap between the corner of tight bar and packing end		±3		

FIG. A2.23 Hull Outfitting

II. WOODWORK						
Division II-A ACCOMMODATION SPACE				SHIPBUILDING QUALITY STANDARDS		
Section 1 DOOR AND DOOR FRAME						
Sub-section	Item	Figure	Standard Range (mm)	Tolerance Limits (mm)	Remarks	
1. Clearance between door and door frame	Between wooden door and door frame		≤2	≤3		
	Between steel door and door frame		≤2	≤3		
Section 2 DIVISIONAL WALL						
1. Fitting of division wall	Deviation	$\delta_1$	≤5	≤8		
Section 3 CEILING						
1. Ceiling clear height	Short of ceiling clear height (clear height)	$\delta$		≤10	To be defined by planned dimension	
Section 4 DETAIL OF DIVISIONAL PARTS						
1. Joint piece of woodwork	Relation between wooden parts and screw hole	$a_1$	≥2.5 D	≥1.5 D	D= dia. of bolt or dia. of screw	
	Deviation from marking line	$\delta_1$	≤2	≤5		

FIG. A2.24 Woodwork

II. WOODWORK			SHIPBUILDING QUALITY STANDARDS		
Division II-A ACCOMMODATION					
Section 4 DETAIL OF DIVISIONAL PARTS					
Sub-section	Item	Figure	Standard Range (mm)	Tolerance Limits (mm)	Remarks
2. Alignment of plywood joint	A joiner (plywood with the last coat of paint)	$\delta_2$ 	$\leq 0.5$	$\leq 1$	
	A joiner (To be veneered)	$\delta_3$ 	$\leq 0.3$	$\leq 0.5$	
	No joiner (To be veneered)	$\delta_4$ 		$\leq 0.3$	
	A joiner with joint pieces (To be veneered)	$\delta_5$ 	$\leq 0.5$	$\leq 1$	
3. Clearance of plywood joint	Plywood with the last coat of paint	$\delta_6$ 	$\leq 0.3$	$\leq 1$	
	Without joint pieces (To be veneered)	$\delta_7$ 	$\leq 0.3$	$\leq 0.5$	
	With joint pieces (To be veneered)	$\delta_8$ 	$\leq 1$	$\leq 2$	
4. Penetrations of wooden wall	Fireproof bulkhead (Clearance and lap length)	$\delta_9$ $a_2$  Pipe duct Screw Stl plt (thickness more than 1.0 mm)	$\leq 2$	$\leq 2.5$ $\geq 25$	
5. Steel panel	Deviation between upper and lower pieces	$\delta_{10}$ 	$\leq 5$	$\leq 8$	
	Alignment of joint	$\delta_{11}$ 	$\leq 0.5$	$\leq 1$	
	Gap of joint	$\delta_{12}$ 	$\leq 0.5$	$\leq 1$	

FIG. A2.25 Woodwork

II. WOODWORK						
Division II-A ACCOMMODATION				SHIPBUILDING QUALITY STANDARDS		
Section 5 DECK COVERING LEVEL				Standard Range (mm)	Tolerance Limits (mm)	Remarks
Sub-section	Item	Figure				
1. Deck composition	Flatness of deck composition	$\delta_1$ 			$\leq 5$	Depth of $\delta_1$ in two meters.
2. Deck covering	Flatness of deck covering	Ditto			$\leq 5$	Ditto
Division II-B DECK COMPARTMENT						
Section 1 ON DECK						
1. Deck planking	Gap between deck planking and steel deck	$\delta_1$ 		$\leq 7$	$\leq 9$	Distortion of steel deck is based on quality standard for hull. Deck planking is based on quality standard for bare steel parts.
Section 2 IN HOLD						
1. Clearance between spanning and cleat	Horizontal	$a_1$ 		$\leq 6$	$\leq 10$	
	Longitudinal	$a_2$ 		$\leq 6$	$\leq 10$	
2. Location of cleat	Deviation of spanning from face	$a_3$ 		$10 \leq a_3$ $a_3 \leq 15$	$5 \leq a_3$ $a_3 \leq 20$	Fitting accuracy of cleat is defined as installed. In case where it is impossible to comply with the standard due to form of frames. Spanning is to be divided as appropriate.
Section 3 THE COLD STORAGE SPACES						
1. Door	Air tightness of door				Not defined	To be checked by chalk test. No measurable frost outside the cold storage spaces under refrigerating test. In case where it frosts, blow air from the outside and check with leakage of air with a candle or a joss stick in the cold storage space.

FIG. A2.26 Woodwork

IV. MACHINERY						
Division IV-A RUDDER				SHIPBUILDING QUALITY STANDARDS		
Section 1. RUDDER PLATE AND RUDDER STOCK						
Sub-section	Item	Figure	Standard Range (mm)	Tolerance Limits (mm)	Remarks	
1. Reamer	Dimension of reamer bolt hole Roundness Cylindrical			$\leq 0.01$ $\leq 0.02$	D1: dia of bolt d1: dia of hole	
	Dimension of reamer bolt hole Roundness Cylindrical					$ D_1 - D_2 $ $ D_2 - D_3 $
	Interference of reamer bolt					$ d_1 - d_2 $ $ d_2 - d_3 $ $d - D$
2. Join	Facing surface area between rudder plate and rudder stock			$> 60\%$ $\leq 0.3$ $\pm 3$ $\pm 4$ $\pm 5$ $< 0.03$	*not defined Both longitudinal and transverse deviations are to comply with this standard * * * * * After tightening of reamer bolt	
	Deviation from the center line of rudder and rudder stock after connection					$\delta_1$
	Length of rudder plate and rudder stock after connection					
	Length of rudder stock					$\delta_2$
	Length of rudder plate					$\delta_3$
	Total length					$\delta_2 + \delta_3$
	Gap between rudder plate and rudder stock after connection					$\delta_4$
3. Sleeve of rudder stock	Interference for sleeve of rudder stock			$(5-10)d_1$ $10,000$ $(10-20)d_3$ $10,000$	*not defined d1: outside dia. of rudder stock d3: outside dia. of sleeve	
	(S U S)					$d_3 - d_4$
	(B C)	$d_3 - d_4$				
Section 2. Pintle and gudgeon bushing						
1. Pintle	Facing surface area between pintle and taper of rudder plate			$> 60\%$ $(5-10)d_1$ $10,000$ $(10-20)d_1$ $10,000$	*not defined * * d1: outside dia. of pintle d2: inside dia. of sleeve	
	Interference for pintle of rudder stock					
	(S U S)					$d_1 - d_2$
	(B C)	$d_1 - d_2$				
2. Gudgeon bushing	Interference of gudgeon bushing			$0 - 0.05$	*not defined d3: outside dia. of pintle d4: inside dia. of sleeve	
	(B C, SUS)	$d_2 - d_3$				
	(Synthetic resin)	$d_4 - d_3$				

FIG. A2.27 Machinery

IV. MACHINERY						
Division IV-A Rudder				SHIPBUILDING QUALITY STANDARDS		
Section		3. Stern frame				
Sub-section	Item		Figure	Standard Range (mm)	Tolerance Limits (mm)	Remarks
1. Gudgeon center line	Alignment of centerline for rudder carriers, upper & lower gudgeons after boring, or after craming eccentric bushing	$\delta_1$		$\leq 0.3$	$\leq 0.5$	Both longitudinal and transverse deviations are to comply to this standard
Section		4. Rudder tiller				
1. Rudder stock and tiller	Interference of rudder stock and tiller Interference of taper key			0.005 -0.015	>0 >0	
2. Rudder stock and tiller with taper	Facing surface area between rudder stock and tiller Fastening clearance of taper key			>60% 0.005 -0.015	* >0	*not defined
Section		5. Rudder carrier and stuffing box				
1 Installation	Facing surface area of liner Gap between rudder carrier and liner			>50% <0.05	* *	not defined This standard is also applied to that of stuffing box To be measured in the condition before tightening of up bolts
Division IV-B Steering engine						
Section		1. Ram cylinder type				
1 Reamer bolt	Interference	d-D		0.01	>0	d: dia. of bolt D: dia of hole
2 Installation of liner (Top liner Chock liner)	Clearance			<0.06	*	*not defined In the condition before tightening of bolts
3 Level and torsion of ram cylinder	Level and torsion			$\frac{10}{\leq 100}$	Within 75% of clearance of ram cylinder	

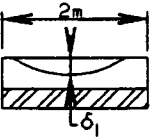
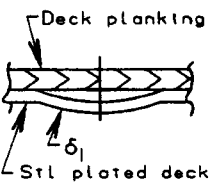
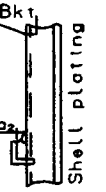
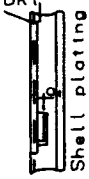
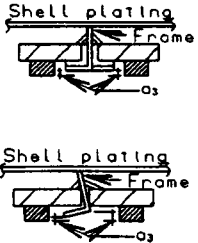
FIG. A2.28 Machinery

IV. MACHINERY						
Division IV-B Steering engine				SHIPBUILDING QUALITY STANDARDS		
Section 1. Ram cylinder type						
Sub-section	Item		Figure	Standard Range (mm)	Tolerance Limits (mm)	Remarks
4 Alignment coupling center of hydraulic pump after installation	Inclination of the surface	$ T_1 - T_2 $		$\leq 0.07$	•	In case of solid coupling
	Concentricity			$\leq 0.05$	•	To measure like this figure by means of dial gauge. In case of solid coupling.
Section 2. Rotary vane type						
1 Taper area between rudder stock and boss on steering engine	Facing surface area			$\geq 60\%$	•	*not defined
2 Interference mark on nut at the top of the rudder stock	Push up travel			0.6 -1.0	•	Length of indentation is according to the maker standard  *not defined
3 Alignment of coupling center of hydraulic pump after installation	Inclination of the surface	$ T_1 - T_2 $		$\leq 0.07$	•	In case of solid coupling to be measured by means of dial gauge. See left sketch
	Concentricity			$\leq 0.05$	•	
Division IV-C Deck machine						
Section 1. Installation of machine seat						
1 Clearance between seat and machine	A class			$< 0.06$	$< 0.10$	A class: deck crane and cargo gear
	B class			$< 0.10$	$< 0.20$	B class: pump
	C class			•	•	C class: miscellaneous winch and davit  A B C class to be measured before tightening  *not defined

FIG. A2.29 Machinery

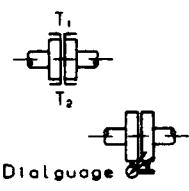
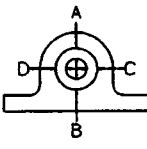

IV. MACHINERY						
Division IV-C Deck machine				SHIPBUILDING QUALITY STANDARDS		
Section 1. Installation of machine seat						
Sub-section	Item		Figure	Standard Range (mm)	Tolerance Limits (mm)	Remarks
2 Alignment of coupling center	Inclination of the surface Concentricity	T <sub>1</sub> -T <sub>2</sub>		≤0.07	•	In case of solid coupling To be measured by means of dial gauge See sketch
				≤0.05	•	
3 Alignment of shaft center		$\frac{ C-D }{2}$		≤0.05	•	A class •not defined



Division IV-D Deck crane						
Section 1. Traveling type (include traveling type hopper)						
1 Laying rail	Distance between center of the rails (one side type)	δ <sub>1</sub>		≤5	•	•not defined
	Distance between center of the rails (both side type)	δ <sub>2</sub>		≤10	•	•not defined
	Horizontal line of rail (for optional 10m)	δ <sub>3</sub>		≤5	•	Standard per meter
	Vertical line of rail (for optional 10m)	δ <sub>4</sub>		≤5	•	Standard per meter
	Slope of rail (for optional 10m)	δ <sub>5</sub>		$< \frac{1}{1000}$	•	Standard per meter
	Plane of rail (for optional 10m)	δ <sub>6</sub>		$< \frac{1}{1000}$	•	
	Inclination of rail	δ <sub>7</sub>		$< \frac{1}{200}$	•	
	Difference of height between port and stbd	δ <sub>8</sub>			≤8	•

FIG. A2.30 Machinery

IV. MACHINERY						
Division IV-D Deck crane				SHIPBUILDING QUALITY STANDARDS		
Section 2. Fixed type						
Sub-section	Item		Figure	Standard Range (mm)	Tolerance Limits (mm)	Remarks
1 Installation of post	Plane of flange	$ \delta_1 $		$\leq 0.4$	•	Difference for diameter •not defined
	Difference of bolt hole on flange	$ \delta_2 $			$\leq 0.6$	
Division IV-E Side thruster						
Section 1. Side thruster						
1 Center of coupling	Clearance between tube and blade	$\delta_1$		50/1000	•	Universal coupling type •not defined
2 Deformation of tube	Clearance between tube and blade	$\delta_1$		$\geq \frac{D}{600}$	•	•not defined

FIG. A2.31 Machinery

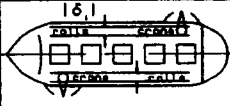
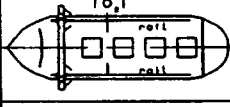
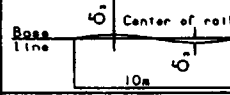
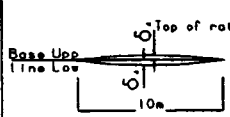
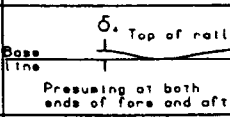
**A3. COATINGS**
**A3.1 Contents**

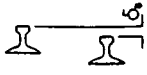
<b>Introduction</b>	
<b>General</b>	A3.2
1. Type of vessel	Fig. A3.1
2. Tank coating area	Fig. A3.1
3. Type of cargo	Fig. A3.1
4. Tank anodes	Fig. A3.1
5. Outfitting	Fig. A3.1
6. Paint to be used	Fig. A3.1
7. Dry film thickness	Fig. A3.1
8. Shop primer	Fig. A3.1
9. Holding coats	Fig. A3.1
10. Painting process	Fig. A3.1
<b>Presurface Preparation Standards</b>	Fig. A3.2
11. Free edge	Fig. A3.2
12. Spatter	Fig. A3.2
13. Undercut	Fig. A3.2
14. Surface damage	Fig. A3.2
15. Manual welding bead	Fig. A3.2
16. Automatic welding bead	Fig. A3.2
17. Overlap welding bead	Fig. A3.2
18. Welding arc strike	Fig. A3.2
19. Gas cut surface	Fig. A3.2
20. Lifting lugs	Fig. A3.2
21. Moisture	Fig. A3.2
22. Oil and grease contaminants	Fig. A3.2
23. Dust and nonvisual contaminants	Fig. A3.2
24. Chalk or slate pencil marks	Fig. A3.2
25. Marking paint	Fig. A3.2
<b>Surface Preparation Standards</b>	
26. Solvent cleaning	Fig. A3.3
27. Mechanical cleaning	Fig. A3.3
28. Abrasive blast cleaning and surface profile	Fig. A3.3
29. Water jetting	Fig. A3.3
30. Abrasives	Fig. A3.3
31. Repairs to shop primed surfaces	Fig. A3.3
<b>Coating Standards</b>	
32. Stripe coating tanks	Fig. A3.4
33. Overall coat	Fig. A3.4
<b>Coating Repair Standards</b>	
34. Sagging	Fig. A3.5
35. Spray dust	Fig. A3.5
36. Foreign matter	Fig. A3.5
37. Crater, pinholes and bubbles	Fig. A3.5
38. Blushing	Fig. A3.5
39. Mechanical damage	Fig. A3.5
40. Insufficient film thickness	Fig. A3.5
<b>Film Thickness Measurement Standards</b>	
41. Film thickness measurement of tank plate	Fig. A3.6
42. Film thickness measurement of tank longitudinal members	Fig. A3.6
43. Film thickness measurement of tank transverse members	Fig. A3.6
<b>Environmental Painting Standards</b>	
44. Temperature	Fig. A3.7
45. Humidity	Fig. A3.7
46. Ventilation (Blasting)	Fig. A3.7
47. Ventilation (Painting)	Fig. A3.7
48. Erection of scaffolding	Fig. A3.7
49. Removal of scaffolding	Fig. A3.7
50. Illumination	Fig. A3.7
<b>Inspection Standards</b>	
51. Presurface preparation	Fig. A3.8
52. Surface preparation	Fig. A3.8
53. Stripe coating	Fig. A3.8
54. Film thickness	Fig. A3.8
55. Final inspection	Fig. A3.8
56. Temperature, humidity, and dew point	Fig. A3.8
57. Gas concentration of solvent	Fig. A3.8
58. Ventilation	Fig. A3.8
<b>Explanations</b>	Figs. A3.9–A3.15

**A3.2 Introduction**

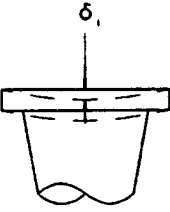
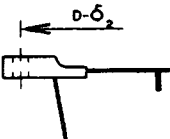
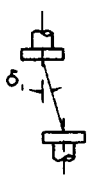
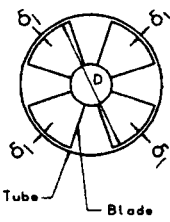
A3.2.1 This practice for coatings addresses those aspects of coating application inherent in achieving finished product quality that can be measured and warranted as meeting acceptable criteria. Because of the nature of coating systems, in which preparation and methodology directly affect finished quality, this practice contains information about processes and

application practices, as well as, pass/fail criteria of the end product. It should be acknowledged that measuring finished coating attributes cannot determine that good application practices were followed and, therefore, cannot be used as a sole means of warranting the finished quality of the coating.

No.	Item	Prerequisites	Remarks
1	<b>Type of Vessel</b>	Commercial and Military	
2	<b>Tank Coating Area</b>	No Limitation	
3	<b>Type of cargo</b>	Products identified in the specification section.	Refer to ship's specification
4	<b>Tank anodes</b>	In accordance with ship's specifications in Water Ballast Tanks and Slop Retention Tank.	Refer to ship's specification. Refer to Fig. A3.9 (Explanations).
5	<b>Outfitting</b>	In the case of steel, painting is similar to the surrounding area. Paint shall not be applied to woodwork, polished fittings, gaskets, packing, anodes, non-ferrous material, or other non-corrosive metals and any other surface or fittings and equipment where paint could obstruct their proper function.	
6	<b>Paint to be used</b>	As specified by owner. Coatings shall be lead free, chromate free, asbestos free, cadmium free and comply with applicable Federal, State and local Regulations	Refer to ship's specification
7	<b>Dry film thickness</b>	Refer to ship's specification and manufacturer's recommendations.	Refer to Fig. A3.9 (Explanations).
8	<b>Shop primer</b>	After primary surface preparation, one (1) coat of inorganic zinc silicate type shop primer will be applied in accordance with the paint manufacturer's recommendation, for structural steel not coated with inorganic zinc silicate type shop primer builder shall blast to SSPC-SP 10 and apply first coat of specified system, subject to owner approval. Surface profile to comply with ship's specification.	
9	<b>Holding coat</b>	As determined by builder with consideration to paint manufacturer's recommendation.	
10	<b>Painting Process</b>	Block unit through completion.	Refer to Fig. A3.9 (Explanations).

FIG. A3.1 General

No.	Item	Process Standard	Judgment	Remarks
11	<b>Free edge In Immersion Service Areas To Be Coated</b>	(1) Break 90 degree edges 1 mm minimum.  (2) In general, rolled angle edges, bulb flats, etc. (including flat bars) are to be left untreated.  	Visual	
12	<b>Spatter In Immersion Service Areas To Be Coated</b>	(1) For spatter observed before blasting: (a) Remove with a chipping hammer, scraper, etc. (b) For spatter not easily removable with a scraper, etc. Use grinder or disc.  Note: It is the intent of this standard that all spatter is to be removed before surface prep. Any remaining or additional spatter observed after surface prep shall be removed in accordance with 1(a) and 1(b).	Visual	
13	<b>Undercut</b>	Undercut to a depth exceeding 1.6mm and a width smaller than the depth is to be repaired by grinding. If a sharp edge exists with a crest exceeding 3mm grind until irregularity is less than 3mm.	Visual	Refer to Fig. A3.10 (Explan.)
14	<b>Surface damage</b>	Surface damage, pitting, break-off marks to depths exceeding 1 mm are to be repaired by welding or grinding	Visual	Refer to Fig. A3.10 (Explan.)
15	<b>Manual welding bead</b>	Weld beads with surface irregularities exceeding 3 mm or with a sharp crest are to be ground until the irregularity is less than 3 mm.	Visual	
16	<b>Automatic welding bead</b>	In general, no specific treatment is required.	Visual	
17	<b>Overlap welding bead</b>	Overlapping weld beads that create sharp notches are to be repaired as per item No. 13, "Undercut".	Visual	
18	<b>Welding arc strike</b>	Same as Item No. 12, "Spatter", and Item No. 14, "Surface Damage."	Visual	
19	<b>Gas cut surface</b>	Gas cut surfaces are to be ground as follows. (a) Except where hull strength considerations require a smooth finish, notches shall be ground to less than 2mm. (b) Gas slag produced during cutting is to be treated according to item 11, "Free Edge." Treatment to be accomplished before blasting.  	Visual	
20	<b>Lifting lugs</b>	Where a lifting lug is partially removed by cutting the pad-eye portion off per page 17 of the Hull volume, the remaining stub and surrounding area is to be treated according to item No. 11 "Free Edge", item No. 15 "Manual welding bead", and item No. 19 "Gas cut surface".	Visual	

FIG. A3.2 Presurface Preparation Standards

No.	Item	Process Standard	Judgment	Remarks
21	Moisture	To be removed until no visible moisture remains	Visual	Refer to Fig. A3.10 (Explan.)
22	Oil and grease contaminants	To be removed, by wiping with thinner, fresh water (preferably high pressure wash), wire brush or compressed air or as permitted by paint manufacturer.	Visual	
23	Dust and non-visual contaminants	Dust and contaminants are to be removed by compressed air, vacuum or high pressure water cleaning, as necessary.	Visual Clear Tape Test Method	
24	Chalk or slate pencil marks	To be removed with rag or brush in accordance with manufacturer's recommendation.	Visual	
25	Marking paint	To be removed by blasting, power tool or other. Marking paint for epoxy does not need to be removed if it is in accordance with paint manufacturer's recommendation	Visual	

FIG. A3.2 Presurface Preparation Standards (continued)

No.	Item	Process Standard	Judgment	Remarks
26	Solvent Cleaning	Refer to ship's specification	Visual Standards	Refer to Fig. A3.11 (Explanations)
27	Mechanical Cleaning	Refer to ship's specification	Visual Standards	
28	Abrasive Blast Cleaning And Surface Profile	Refer to ship's specification	Visual Standards	
29	Water Jetting	Refer to ship's specification	Visual Standards	
30	Abrasives	Refer to ship's specification	Written Standards	
31	Repairs to Shop Primed Surfaces	Refer to ship's specification	Visual Standards	

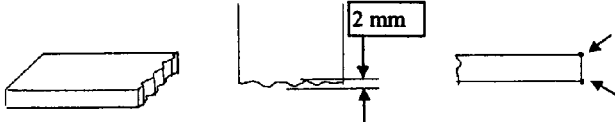
FIG. A3.3 Surface Preparation Standards

No.	Item	Process Standard	Judgment	Remarks
32	Stripe Coating Tanks	To achieve the specified DFT, stripe coats shall be applied to: edges of small holes, corners of other flame burned edges, free edges of structural members, and rough welding seams.	Visual	Refer to Fig. A3.12 (Explanations)
33	Overall coat	When more than one coat is specified, subsequent coats shall not be applied until preceding coat has sufficiently cured/dried in accordance with paint manufacturer's recommendation.	Wet gauge and Visual	

FIG. A3.4 Coating Standards

No.	Item	Process standard	Judgment	Remarks
34	Sagging	Sagging with a height of 2 mm or more is to be repaired in accordance with the paint manufacturer's recommendations.	Visual	Refer to Fig. A3.13 (Explanations)
35	Spray dust	Dry spray, over spray, and spray dust is to be removed before painting in accordance with the manufacturer's recommendations.	Visual	
36	Foreign matter	Foreign matter in the paint film shall be removed. Damaged film is to be repaired in accordance with the manufacturer's recommendations.	Visual	Refer to Fig. A3.13 (Explanations)
37	Crater, pinholes and bubbles	Defects are to be repaired in accordance with the manufacturer's recommendations.	Visual	
38	Blushing	Excepting the final coat film, visible blushing on the film surface is to be repaired in accordance with the manufacturer's recommendations.	Visual	
39	Mechanical damage	Touch up is to be equivalent to the original specification, unless otherwise noted in the Painting Plan.	Visual	
40	Insufficient film thickness	Areas with insufficient film thickness are to be repaired in accordance with the manufacturer's recommendations.	Visual/Dry Film Gage	Refer to Fig. A3.14 (Explanations)

FIG. A3.5 Coating Repair Standards

No.	Item	Process standard	Judgment	Remarks
41	Film thickness measurement of tank plate	Film thickness to be measured for every five square meters for flat panels or corrugated bulkheads. Film thickness is to be measured at two (2) points in each panel of plating bounded by transverse and longitudinal members. (Note: <i>this excludes panel breaker, or panel stiffeners</i> )	Micro tester or electro-magnetic film thickness gauge	Refer to Fig. A3.14 (Explanations)
42	Film thickness measurement of tank longitudinal members	Film thickness to be measured at two points between transverse members on each side of web and face plates (Note: <i>this excludes panel breakers and panel stiffeners</i> )	Micro tester or electro-magnetic film thickness gauge	
43	Film thickness measurement of tank transverse members	Film thickness to be measured at three points between longitudinal girders or bulkhead on each side of web and face plates.	Micro tester or electro-magnetic film thickness gauge	

FIG. A3.6 Film Thickness Measurement Standards

No.	Item	Process standard	Judgment	Remarks
44	<b>Temperature (During painting, and drying)</b>	Steel and air temperatures are to be in accordance with the paint manufacturer's recommendations.	Measure with a thermometer	Refer to Fig. A3.15 (Explanations)
45	<b>Humidity (During painting, and initial drying)</b>	Paint shall not be applied during periods of rain, snow, fog or mist in the open air or when ambient relative humidity exceeds manufacturer recommendation.	Measure with a hygrometer. Measure with a surface thermometer	
46	<b>Ventilation (Immediately before blasting to paint)</b>	Air change rate to be two times per hour, or more as directed by the manufacturer's product data sheet.	Check ventilating requirement	
47	<b>Ventilation (During paint drying)</b>	Air change rate to be five times per hour or more. Dehumidifying capacity to be according to ventilation requirements. If the external air humidity is above 85%, air change rate may be decreased to the capacity of the dehumidifier.	Check ventilating requirement	
48	<b>Erection of scaffolding</b>	Make sure that scaffolding does not interfere with painting, ventilation, illumination, blasting and inspection ( builder shall attempt to maintain a 150 mm clearance wherever possible). If not possible (to maintain the 150 mm clearance), the Owner shall be informed of the particular area and review during the scaffolding inspection.	Visual	
49	<b>Removal of scaffolding</b>	Care must be taken not to damage the film.	Visual	
50	<b>Illumination</b>	Effective illumination to be provided to ensure proper inspection of the blast and coated surface is achieved.	Visual	

FIG. A3.7 Environmental Painting Standards



No.	Item	Standard	Control		
			Owner	Shipyard	Paint Manufacturer
51	Pre-Surface Preparation	Refer to Fig. A3.2	Δ	Δ	Δ
52	Surface Preparation	Refer to Fig. A3.3	Δ	Δ	Δ
53	Stripe Coating	Refer to Fig. A3.12 (Explanations)		Δ	Δ
54	Film Thickness	Refer to Figs. A3.9 and A3.14 (Explanations)		Δ	Δ
55	Final Inspection	Final confirmation of completion of painting	Δ	Δ	Δ
56	Temperature Humidity and Dew Point	Refer to Fig. A3.15 (Explanations)		Δ	Δ
57	Gas Concentration Of solvent	Refer to Fig. A3.15 (Explanations)		Δ	Δ
58	Ventilation	Refer to Fig. A3.15 (Explanations)		Δ	Δ

FIG. A3.8 Inspection Standards

NO.	Item	Explanation
4	<b>Tank anodes</b>	<p>(1) Anodes may be installed in ballast tanks which are often loaded with sea water.</p> <p>(2) Anodes are not to be installed when dissolution of zinc into the tank contents presents problems (as in the case of jet fuel, etc.).</p>
7	<p><b>Dry film thickness for Ballast Tanks, Fore/Aft Peak Tanks, Wet Spaces and Water Tanks shown. See note for all other spaces.</b></p>	<p>Measurements at 80% of total measuring points must verify a film thickness exceeding or equal to a specified value (e.g., 300 microns). For the remaining 20%, the measured film thickness must be equal to or over 80% (e.g., 240 micron) of the specified thickness. <i>(Note: All other tank spaces the 90-10 rule shall apply, All other surfaces to SSPC-PA 2)</i></p> 
10	<p><b>Tank painting process (Typical; guideline only, deviations are acceptable)</b></p>	<p>(1) For tank coating, block painting, painting in a dry dock, afloat painting, or any combination is considered. However this standard is based on afloat painting only.</p> <p>(2) For abrasive blasting and painting in tank, the following two systems may be considered:</p> <div style="display: flex; justify-content: space-around;"> <div style="text-align: center;"> <p><b>System A</b></p>  </div> <div style="text-align: center;"> <p><b>System B</b></p>  </div> </div>

FIG. A3.9 General (Explanations)



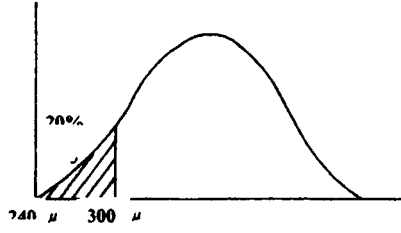
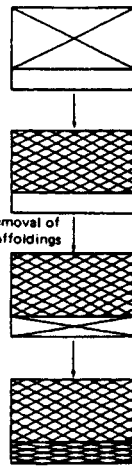
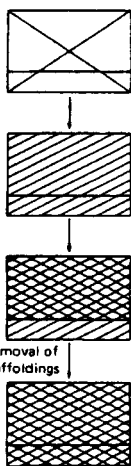

No.	Item	Explanation					
		Division		Welding			
		section	Sub-section	Item	Tolerance Limits	Remarks	
13	Undercut		hgt. of reinf. brth. of bead, flank of ang.		 <p>h: not defined B: not defined <math>\theta = 90^\circ</math></p>	 <p>In cases where <math>\theta</math> is over <math>90^\circ</math>, repair by grinding or welding to make <math>\theta = 90^\circ</math></p>	
			undercut (butt weld)	Skin plate and face plate between $0.6\phi$	Over 90 mm continuous $d = 1.6\text{mm}$		To be repaired by welding electrode or other, (carefully avoid short bead for higher tensile steels).
			undercut fill	Others	$d = 1.6\text{mm}$		
			leg lgth.			 <p><math>d \leq 1\text{mm}</math></p>	
				Compared with correct ones		 <p>L: Leg length t: Throat depth <math>L \geq 0.9</math> <math>t \geq 0.9</math></p>	If over tolerance, fill weld to correct.
14	Surface damage	Division		Material			
		section	Sub-section	Item	Remarks		
		surface flaw	Pit	Grade of pitting	<ol style="list-style-type: none"> <li>Grade A is considered slight and no repair is necessary. Grade B is medium and is to be repaired if necessary. Grade C requires some repair.</li> <li>Pitting or flaking on boundaries of grade "A" and "B", grade "B" and "C", and grade "A" and "C" shall be classified as grade "A", grade "B" and grade "A" respectively.</li> <li>Repair method of surface flaw: depth of defect = d, plate thickness = t (<math>d = .07 t</math> remove by grinding (but in no case <math>d = 3 \text{ mm}</math>), <math>.07 t = d = .2 t</math> grinding followed by welding.</li> </ol>		
surface flaw	Flaking	Grade of surface flaking	<ol style="list-style-type: none"> <li>Grade A is considered slight and no repair is necessary. Grade B is medium and is to be repaired if necessary. Grade C needs some repair.</li> <li>Pitting or flaking on boundaries of grade "A" and "B", grade "B" and "C", and grade "A" and "C" shall be classified as grade "A", grade "B" and grade "A" respectively.</li> <li>Repair method of surface flaw depth of defects = d, plate thickness = t, <math>d = .07 t</math> removed by grinding (but in no case <math>d = 3 \text{ mm}</math>), <math>.07 t = d = .2 t</math> grinding followed by welding.</li> </ol>				

FIG. A3.10 Preparation Standards for Steel (Explanations)

21	<b>Moisture</b>	Rainwater inflow and moisture in the air may produce sweat on steel surface. After secondary surface preparation, moisture may cause turning or hinder adhesion. Appropriate measures must be taken to prevent rainwater from flowing in.
22	<b>Oil and grease contaminants</b>	In general, remove with a rag and thinner/cleaner. For heavy adhesion of grease and oil, first dissolve with a brush soaked in thinner/cleaner, then wipe off with a clean rag. Detect oil visually with a black light or water spray bottle (water break test).
23	<b>Dust and non-visual contaminants</b>	Check for dust with clear tape, clean cloth or pictorial standard in accordance with ISO 8502-3. Remove dust by compressed air or vacuum. Non-visual contaminants may be removed in accordance with SSPC-SP 12/NACE No. 5 as applicable to meet the ship's specification and manufacturer's recommendation. Check for soluble salts according to ISO 8502-6 when required by manufacturer or ship's specification.
24	<b>Chalk or slate pencil marks</b>	Remove with a rag or brush. When marks enter an anchor-pattern concavity and are difficult to remove, use a hard brush.

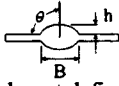
FIG. A3.10 (continued)

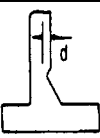
No.	Item	Explanation
26	<b>Solvent Cleaning</b>	Surface cleanliness is to be in accordance with SSPC-SP 1. Note: SSPC-SP 1 is required prior to all other surface preparation methods.
27 52	<b>Mechanical Cleaning</b>	SSPC-SP 3 is the minimum accepted method of repair for non-immersion service substrates. (SSPC-SP 2 may be substituted where SSPC-SP 3 is impractical). SSPC-SP 11 is the minimum accepted method for repair of immersion service substrates. To determine surface cleanliness, refer to the SSPC-VIS 3 photographic standard. To determine surface profile use ASTM D 4417 Method A or B.
28 52	<b>Abrasive Blast Cleaning and Surface Profile</b>	SSPC-SP 10 is the minimum accepted surface preparation for pre-construction primer and for immersion service substrates. SSPC-SP 7 may be used in place of SSPC-SP 3 when practical. For cleanliness refer to SSPC-VIS 1-89 photographic standard. To determine surface profile use ASTM D 4417 Method A or B.
29 52	<b>Water Jetting</b>	Where acceptable according to the ship's specification and manufacturer's recommendations, clean in conformance with SSPC-SP 12/NACE No. 5. Refer to SSPC-VIS 4(1)/NACE No. 7 photographic standard. To confirm pre-existing surface profile use ASTM D 4417.
30	<b>Abrasives</b>	Blast surface color tends to vary depending on the abrasive material used. As long as the same grade of cleanliness is used, a difference in color does not affect the film performance. Abrasives to be determined according to SSPC-AB 1. Recycled Abrasive Cleanliness to be determined according to SSPC-AB 2.
31	<b>Repairs to shop primed surfaces</b>	(1) In general shop primer in the cargo oil and slop retention tanks shall be removed in accordance with manufacturer's recommendation to a visual acceptance. (2) All other spaces intact shop primer may remain and over coated in accordance with manufacturer's recommendation. (3) In no way does the above supercede the ship's specification

FIG. A3.11 Surface Preparation Standards (Explanations)

No.	Item	Explanation
32	<p><b>Stripe coating in tanks.</b></p>	<p>Where airless spraying is difficult and the film thickness can not be maintained, apply stripe coating with a brush before or after spraying.</p> <p>Stripe coating locations are as follows:</p> <ul style="list-style-type: none"> <li>(a) Inside and edges of holes ..... ①</li> <li>(b) Free edges ..... ②</li> <li>(c) Welding beads ..... ③</li> <li>(d) Where painting is difficult ..... ④</li> </ul> 

FIG. A3.12 Coating Standards (Explanations)

No.	Item	Explanation
34	"Sagging"	<p>The "sagging" of the film needs repair due to the following causes:</p> <ol style="list-style-type: none"> <li>(1) Spray dust, dust, etc. tend to collect.</li> <li>(2) Sag having a large film thickness. Solvent tends to collect on high film thicknesses.</li> </ol> <p>If coating is applied over the "sagging" area, solvent evaporation becomes more difficult leading to possible cracks in the film.</p> <p>"Sagging" to be repaired is as follows:</p> <ol style="list-style-type: none"> <li>(a) Sagging with the height of 2mm and more.           <div style="display: flex; align-items: center; margin-top: 10px;">  </div> </li> <li>(b) Wide "sagging"           <div style="display: flex; align-items: center; margin-top: 10px;">   </div> </li> <li>(c) "Sagging" in the bottom corners           <div style="display: flex; align-items: center; margin-top: 10px;">  </div> </li> </ol>

FIG. A3.13 Coating Repair Standards (Explanations)

No.	Item	Explanation
36	<b>Foreign matter</b>	<p>When abrasives are used in surface preparations (blasting), abrasives remaining may adhere to the substrate and be trapped in the film during painting.</p> <p style="text-align: center;">Foreign matter</p>  <p style="text-align: right;">Film</p> <p style="text-align: center;">Steel plate</p> <p>Foreign material shall be removed by screen, sanding, etc. as directed by the paint manufacturer.</p>
37	<b>Craters, pinholes, and bubbles</b>	<p>(1) Pinholes tend to occur at the pit of manual welding bead.</p> <p>(2) Craters tend to occur when surface tension becomes uneven during the film drying process. A crater is a concave, and reduces film thickness.</p> <p style="text-align: center;">Crater</p>  <p style="text-align: right;">Film</p> <p style="text-align: center;">Steel plate</p> <p>(3) Bubbles occur when paint mixed with air is applied in the airless painting.</p> <p>Repairs to coating to be in accordance with manufacturer recommendations. Generally, surface will be feathered by sanding or screening and coating applied to achieve desired DFT.</p>
38	<b>“Blushing”</b>	<p>The film will “blush”, due to humidity absorbed by the hardening agent. When humidity rises or dew is produced before curing, this may occur. Blushing is confined to the film surface and does not affect film performance. However, excessive blushing must be repaired because it hinders adhesion of overcoating.</p>
39	<b>Mechanical damage</b>	<p>The surface of the film shall be lightly abraded with sandpaper, screen, or as recommended by coating manufacturer and coating applied to the desired DFT.</p>  <p style="text-align: center;">Steel plate</p> <p style="text-align: center;">Steel plate</p> <p style="text-align: right;">Feather</p>

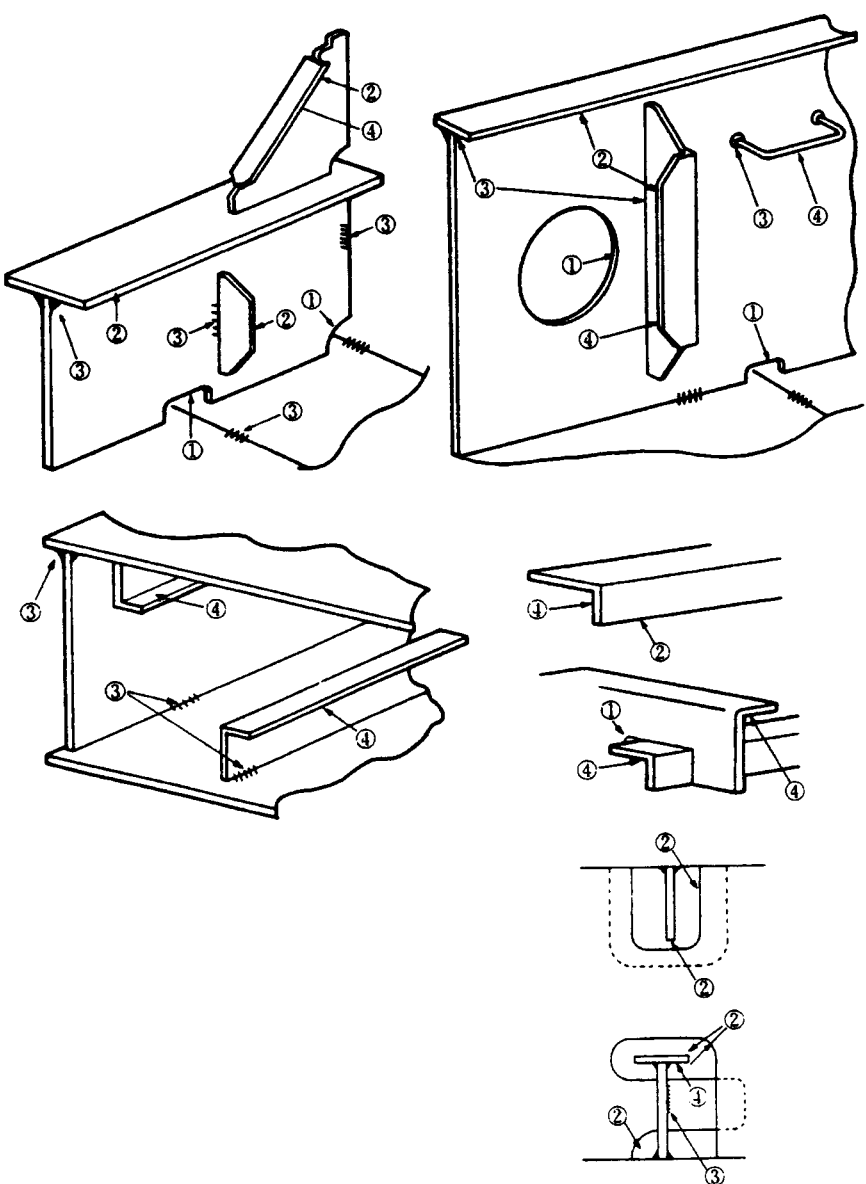
FIG. A3.13 (continued)

No.	Item	Explanation
40	<b>Film thickness measurement in tanks.</b> <b>For other areas see Note.</b>	(1) Measuring equipment to be adjusted once a day by using a reference plate with a thickness nearest to the film thickness to be measured.
41		(2) The measured value of film thickness to be marked at a measuring point using a specified marking material.
42		Film thickness measuring point (x mark)
43		(a) Bottom part
44		
		(b) Deck part
		
		NOTE: ( For all other areas, measure every 93m <sup>2</sup> (1,000 ft <sup>2</sup> ) in accordance with SSPC-PA 2)

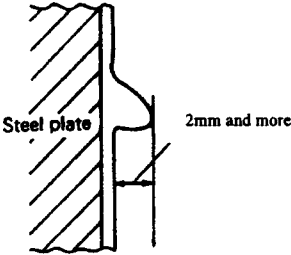
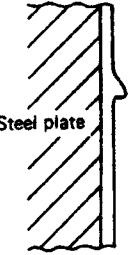
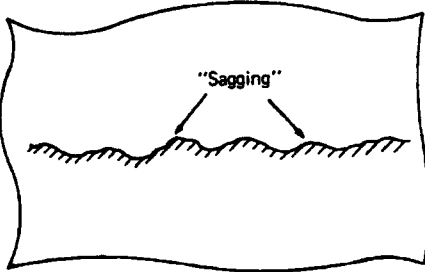
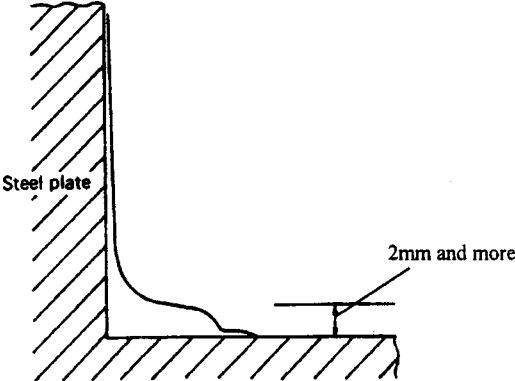
FIG. A3.14 Film Thickness Measurement Standards (Explanations)

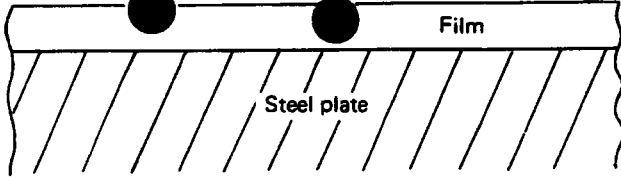
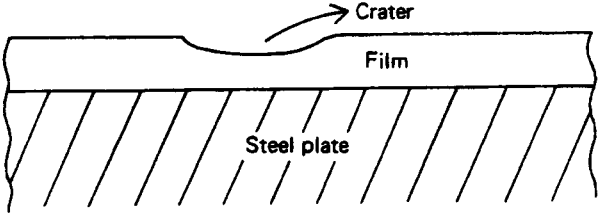
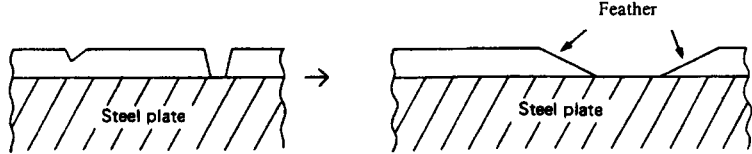

No.	Item	Explanation
44	<b>Temperature (During painting and drying)</b>	<p>(1) Lowest temperature</p> <p>(a) Temperature must be 3° C or more above the dew point. Theoretically the steel plate surface temperature is used. However the air temperature in tank is practically used herein.</p> <p>(b) Curing of epoxy resin slows down when the temperature drops below 10° C and 5° C is the lowest limit. It is preferable to keep the temperature above 10° C and in conformance with the paint manufacturer’s recommendation.</p> <p>(2) Highest temperature</p> <p>The maximum temperature is affected by the type of paint used and the painting process. Consult the paint manufacturer for maximum allowable temperature for application and cure.</p>
45	<b>Humidity (During painting, and initial drying)</b>	<p>Relative humidity is to be below 85% .</p> <p>This value applies when the painted surface temperature is equal to or above the atmospheric temperature.</p>
46 47	<b>Ventilation</b>	<p>(1) The amount of ventilation required during painting and drying is greater than that required for blasting due to the following reasons:</p> <p>(a) The film begins hardening with evaporation of solvents in the film.</p> <p>(b) Solvent evaporation is greatly influenced by ventilation and temperature.</p> <p>(c) Retained solvents affect film performance.</p> <p>(2) Air change rate</p> <p>This standard is determined for correct film performance and this varies depending on tank capacity. These standards are different from OSHA 29 CFR 1915.35 and OSHA 29 CFR 1926.57. Consult “Industrial Ventilation, 20<sup>th</sup> Edition”<sup>1</sup> and OSHA Technical Manual Section III: Chapter 3 for guidance.</p> <p>(3) Air change rate for high humidity (85% RH or above). With high humidity, dew must be prevented after painting, from blasting stages up to the film hardening stages. Otherwise, the following may occur:</p> <p>(a) Turning of blasted surfaces</p> <p>(b) Film defects (Blushing, poor adhesion)</p> <p>As described above in (1) insufficient ventilation also deteriorates film performance. Consequently it is preferable to ventilate at least three times per hour even with high humidity for two days (this varies according to the type of paint) immediately after painting.</p>

FIG. A3.15 Environmental Painting Standards (Explanations)

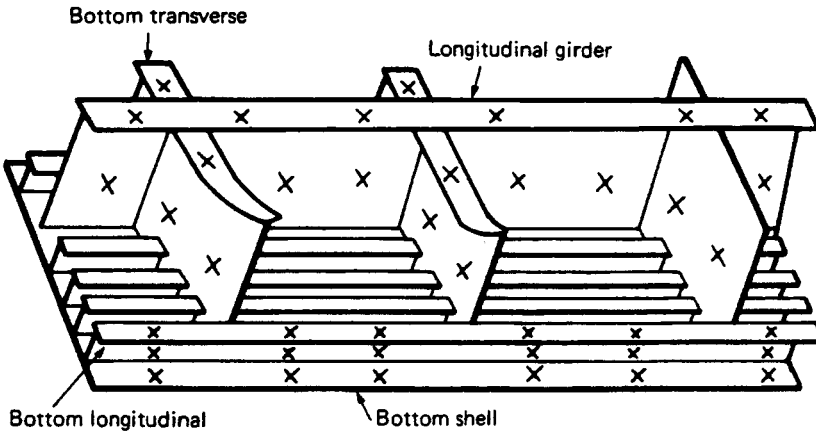
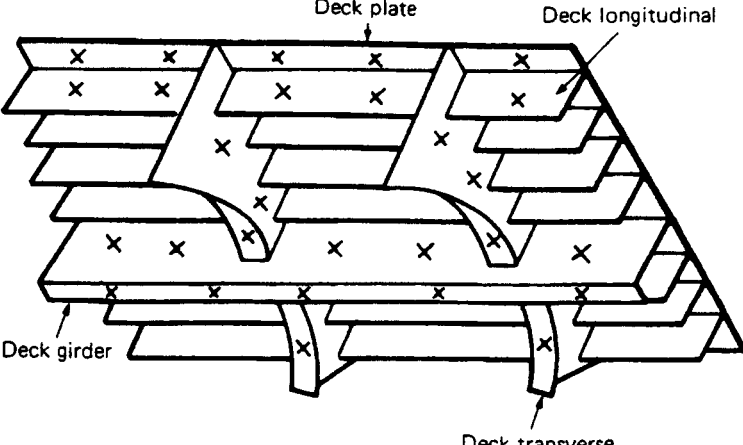
No.	Item	Explanation
46 47	<b>The safety and Health Standards for Painting</b>	<p>(1) The safety and Health Standards for Painting</p> <p>(a) When gas concentration reaches 10% of the lower explosion limit (LEL), stop operations and evacuate workers.</p> <p>(b) When gas concentration exceeds 10% of the lower explosion limit (LEL), take appropriate measures such as adding fans and reducing the number of paint sprayers. Refer to OSHA 29 CFR 1915.35 and 29 CFR 1926.57 Consult "Industrial Ventilation, 20<sup>th</sup> Edition" <sup>1</sup> OSHA Technical Manual Section III: Chapter 3 for guidance.</p>
45 46 47	<b>Instruments for measuring environmental conditions</b>	<p>(1) For humidity and dew point:</p> <p style="padding-left: 40px;">Sling psychrometer and psychrometric tables or battery operated psychrometer according to ASTM E 337 Standard.</p> <p>(2) Surface temperature</p> <p style="padding-left: 40px;">Magnetic contact surface thermometer.</p> <p>(3) Anemometer</p> <p style="padding-left: 40px;">Used to measure the ventilation volume and rate.</p>
48 49	<b>Erection of scaffoldings</b>	<p>(1) Scaffolding pieces</p> <p style="padding-left: 40px;">Scaffolding pieces not to be removed are recommended to be of stainless steel.</p> <p>(2) The distance between painted surfaces and scaffolding is to be between 150 and 300 mm (to prevent unpainted portions).</p> <p>(3) Scaffold planks of expanded metal or similar open design to assist in abrasive removal and ventilation.</p> <p>(4) Height of scaffolding; 1,700 to 1,900 mm (to ensure easy and satisfactory work).</p>
50	<b>Illumination</b>	Explosion-proof lighting is to be used during painting and drying.

FIG. A3.15 (continued)

*ASTM International takes no position respecting the validity of any patent rights asserted in connection with any item mentioned in this standard. Users of this standard are expressly advised that determination of the validity of any such patent rights, and the risk of infringement of such rights, are entirely their own responsibility.*

*This standard is subject to revision at any time by the responsible technical committee and must be reviewed every five years and if not revised, either reapproved or withdrawn. Your comments are invited either for revision of this standard or for additional standards and should be addressed to ASTM International Headquarters. Your comments will receive careful consideration at a meeting of the responsible technical committee, which you may attend. If you feel that your comments have not received a fair hearing you should make your views known to the ASTM Committee on Standards, at the address shown below.*

*This standard is copyrighted by ASTM International, 100 Barr Harbor Drive, PO Box C700, West Conshohocken, PA 19428-2959, United States. Individual reprints (single or multiple copies) of this standard may be obtained by contacting ASTM at the above address or at 610-832-9585 (phone), 610-832-9555 (fax), or [service@astm.org](mailto:service@astm.org) (e-mail); or through the ASTM website ([www.astm.org](http://www.astm.org)).*