



Designation: E 112 – 96^{ε2}

Standard Test Methods for Determining Average Grain Size¹

This standard is issued under the fixed designation E 112; the number immediately following the designation indicates the year of original adoption or, in the case of revision, the year of last revision. A number in parentheses indicates the year of last reappraisal. A superscript epsilon (ϵ) indicates an editorial change since the last revision or reappraisal.

This standard has been approved for use by agencies of the Department of Defense.

^{e1} NOTE—Equations A1.4, A1.5 and A1.6 were editorially revised in April 2000.

^{ε2} NOTE—New numbers were assigned to the adjuncts in February 2003.

INTRODUCTION

These test methods of determination of average grain size in metallic materials are primarily measuring procedures and, because of their purely geometric basis, are independent of the metal or alloy concerned. In fact, the basic procedures may also be used for the estimation of average grain, crystal, or cell size in nonmetallic materials. The comparison method may be used if the structure of the material approaches the appearance of one of the standard comparison charts. The intercept and planimetric methods are always applicable for determining average grain size. However, the comparison charts cannot be used for measurement of individual grains.

1. Scope

1.1 These test methods cover the measurement of average grain size and include the comparison procedure, the planimetric (or Jeffries) procedure, and the intercept procedures. These test methods may also be applied to nonmetallic materials with structures having appearances similar to those of the metallic structures shown in the comparison charts. These test methods apply chiefly to single phase grain structures but they can be applied to determine the average size of a particular type of grain structure in a multiphase or multiconstituent specimen.

1.2 These test methods are used to determine the average grain size of specimens with a unimodal distribution of grain areas, diameters, or intercept lengths. These distributions are approximately log normal. These test methods do not cover methods to characterize the nature of these distributions. Characterization of grain size in specimens with duplex grain size distributions is described in Test Methods E 1181. Measurement of individual, very coarse grains in a fine grained matrix is described in Test Methods E 930.

1.3 These test methods deal only with determination of planar grain size, that is, characterization of the two-dimensional grain sections revealed by the sectioning plane. Determination of spatial grain size, that is, measurement of the

size of the three-dimensional grains in the specimen volume, is beyond the scope of these test methods.

1.4 These test methods describe techniques performed manually using either a standard series of graded chart images for the comparison method or simple templates for the manual counting methods. Utilization of semi-automatic digitizing tablets or automatic image analyzers to measure grain size is described in Test Methods E 1382.

1.5 These test methods deal only with the recommended test methods and nothing in them should be construed as defining or establishing limits of acceptability or fitness of purpose of the materials tested.

1.6 The measured values are stated in SI units, which are regarded as standard. Equivalent inch-pound values, when listed, are in parentheses and may be approximate.

1.7 *This standard does not purport to address all of the safety concerns, if any, associated with its use. It is the responsibility of the user of this standard to establish appropriate safety and health practices and determine the applicability of regulatory limitations prior to use.*

1.8 The paragraphs appear in the following order:

Section	Number
Scope	1
Referenced Documents	2
Terminology	3
Significance and Use	4
Generalities of Application	5
Sampling	6
Test Specimens	7
Calibration	8
Preparation of Photomicrographs	9
Comparison Procedure	10

¹ These test methods are under the jurisdiction of ASTM Committee E-4 on Metallography and are the direct responsibility of Subcommittee E04.08 on Grain Size.

Current edition approved May 10, 1996. Published July 1996. Originally published as E 112 – 55 T. Last previous edition E 112 – 95.

Planimetric (Jeffries) Procedure	11
General Intercept Procedures	12
Heyn Linear Intercept Procedure	13
Circular Intercept Procedures	14
Hilliard Single-Circle Procedure	14.2
Abrams Three-Circle Procedure	14.3
Statistical Analysis	15
Specimens with Non-equiaxed Grain Shapes	16
Specimens Containing Two or More Phases or Constituents	17
Report	18
Precision and Bias	19
Keywords	20
Annexes:	
Basis of ASTM Grain Size Numbers	Annex A1
Equations for Conversions Among Various Grain Size Measurements	Annex A2
Austenite Grain Size, Ferritic and Austenitic Steels	Annex A3
Fracture Grain Size Method	Annex A4
Requirements for Wrought Copper and Copper-Base Alloys	Annex A5
Application to Special Situations	Annex A6
Appendixes:	
Results of Interlaboratory Grain Size Determinations	Appendix X1
Referenced Adjuncts	Appendix X2

2. Referenced Documents

2.1 *ASTM Standards:*

- E 3 Practice for Preparation of Metallographic Specimens²
- E 7 Terminology Relating to Metallography²
- E 407 Practice for Microetching Metals and Alloys²
- E 562 Practice for Determining Volume Fraction by Systematic Manual Point Count²
- E 691 Practice for Conducting an Interlaboratory Study to Determine the Precision of a Test Method³
- E 883 Guide for Reflected-Light Photomicrography²
- E 930 Test Methods for Estimating the Largest Grain Observed in a Metallographic Section (ALA Grain Size)²
- E 1181 Test Methods for Characterizing Duplex Grain Sizes²
- E 1382 Test Methods for Determining Average Grain Size Using Semiautomatic and Automatic Image Analysis²

2.2 *ASTM Adjuncts:*

- 2.2.1 For a complete adjunct list, see Appendix X2

3. Terminology

3.1 *Definitions*—For definitions of terms used in these test methods, see Terminology E 7.

3.2 *Definitions of Terms Specific to This Standard:*

3.2.1 *ASTM grain size number*—the ASTM grain size number, *G*, was originally defined as:

$$N_{AE} = 2^{G-1} \tag{1}$$

where *N_{AE}* is the number of grains per square inch at 100X magnification. To obtain the number per square millimetre at 1X, multiply by 15.50.

3.2.2 *grain*—that area within the confines of the original (primary) boundary observed on the two-dimensional plane-

of-polish or that volume enclosed by the original (primary) boundary in the three-dimensional object. In materials containing twin boundaries, the twin boundaries are ignored, that is, the structure on either side of a twin boundary belongs to the grain.

3.2.3 *grain boundary intersection count*—determination of the number of times a test line cuts across, or is tangent to, grain boundaries (triple point intersections are considered as 1-1/2 intersections).

3.2.4 *grain intercept count*—determination of the number of times a test line cuts through individual grains on the plane of polish (tangent hits are considered as one half an interception; test lines that end within a grain are considered as one half an interception).

3.2.5 *intercept length*—the distance between two opposed, adjacent grain boundary intersection points on a test line segment that crosses the grain at any location due to random placement of the test line.

3.3 *Symbols: Symbols:*

- α = matrix grains in a two phase (constituent) microstructure.
- A* = test area.
- \bar{A} = mean grain cross sectional area.
- AI_ℓ* = grain elongation ratio or anisotropy index for a longitudinally oriented plane.
- \bar{d} = mean planar grain diameter (Plate III).
- \bar{D} = mean spatial (volumetric) grain diameter.
- f* = Jeffries multiplier for planimetric method.
- G* = ASTM grain size number.
- ℓ = mean lineal intercept length.
- $\bar{\ell}_\alpha$ = mean lineal intercept length of the α matrix phase in a two phase (constituent) microstructure.
- $\bar{\ell}_\ell$ = mean lineal intercept length on a longitudinally oriented surface for a non-equiaxed grain structure.
- $\bar{\ell}_t$ = mean lineal intercept length on a transversely oriented surface for a non-equiaxed grain structure.
- $\bar{\ell}_p$ = mean lineal intercept length on a planar oriented surface for a non-equiaxed grain structure.
- ℓ_0 = base intercept length of 32.00 mm for defining the relationship between *G* and ℓ (and *N_L*) for macroscopically or microscopically determined grain size by the intercept method.
- L* = length of a test line.
- M* = magnification used.
- M_b* = magnification used by a chart picture series.
- n* = number of fields measured.
- N_α* = number of α grains intercepted by the test line in a two phase (constituent) microstructure.
- N_A* = number of grains per mm² at 1X.

² Annual Book of ASTM Standards, Vol 03.01.

³ Annual Book of ASTM Standards, Vol 14.02.

$N_{A\alpha}$	= number of α grains per mm^2 at 1X in a two phase (constituent) microstructure.
N_{AE}	= number of grains per inch^2 at 100X.
$N_{A\ell}$	= N_A on a longitudinally oriented surface for a non-equiaxed grain structure.
N_{At}	= N_A on a transversely oriented surface for a non-equiaxed grain structure.
N_{Ap}	= N_A on a planar oriented surface for a non-equiaxed grain structure.
N_i	= number of intercepts with a test line.
N_{Inside}	= number of grains completely within a test circle.
$N_{\text{Intercepted}}$	= number of grains intercepted by the test circle.
N_L	= number of intercepts per unit length of test line.
$N_{L\ell}$	= N_L on a longitudinally oriented surface for a non-equiaxed grain structure.
N_{Lt}	= N_L on a transversely oriented surface for a non-equiaxed grain structure.
N_{Lp}	= N_L on a planar oriented surface for a non-equiaxed grain structure.
P_i	= number of grain boundary intersections with a test line.
P_L	= number of grain boundary intersections per unit length of test line.
$P_{L\ell}$	= P_L on a longitudinally oriented surface for a non-equiaxed grain structure.
P_{Lt}	= P_L on a transversely oriented surface for a non-equiaxed grain structure.
P_{Lp}	= P_L on a planar oriented surface for a non-equiaxed grain structure.
Q	= correction factor for comparison chart ratings using a non-standard magnification for microscopically determined grain sizes.
Q_m	= correction factor for comparison chart ratings using a non-standard magnification for macroscopically determined grain sizes.
s	= standard deviation.
S_V	= grain boundary surface area to volume ratio for a single phase structure.
$S_{V\alpha}$	= grain boundary surface area to volume ratio for a two phase (constituent) structure.
t	= students' t multiplier for determination of the confidence interval.
$V_{V\alpha}$	= volume fraction of the α phase in a two phase (constituent) microstructure.
95 % CI	= 95 % confidence interval.
% RA	= percent relative accuracy.

4. Significance and Use

4.1 These test methods cover procedures for estimating and rules for expressing the average grain size of all metals consisting entirely, or principally, of a single phase. The test

methods may also be used for any structures having appearances similar to those of the metallic structures shown in the comparison charts. The three basic procedures for grain size estimation are:

4.1.1 *Comparison Procedure*—The comparison procedure does not require counting of either grains, intercepts, or intersections but, as the name suggests, involves comparison of the grain structure to a series of graded images, either in the form of a wall chart, clear plastic overlays, or an eyepiece reticle. There appears to be a general bias in that comparison grain size ratings claim that the grain size is somewhat coarser ($1/2$ to 1 G number lower) than it actually is (see X1.3.5). Repeatability and reproducibility of comparison chart ratings are generally ± 1 grain size number.

4.1.2 *Planimetric Procedure*—The planimetric method involves an actual count of the number of grains within a known area. The number of grains per unit area, N_A , is used to determine the ASTM grain size number, G . The precision of the method is a function of the number of grains counted. A precision of ± 0.25 grain size units can be attained with a reasonable amount of effort. Results are free of bias and repeatability and reproducibility are less than ± 0.5 grain size units. An accurate count does require marking off of the grains as they are counted.

4.1.3 *Intercept Procedure*—The intercept method involves an actual count of the number of grains intercepted by a test line or the number of grain boundary intersections with a test line, per unit length of test line, used to calculate the mean lineal intercept length, $\bar{\ell}$. $\bar{\ell}$ is used to determine the ASTM grain size number, G . The precision of the method is a function of the number of intercepts or intersections counted. A precision of better than ± 0.25 grain size units can be attained with a reasonable amount of effort. Results are free of bias; repeatability and reproducibility are less than ± 0.5 grain size units. Because an accurate count can be made without need of marking off intercepts or intersections, the intercept method is faster than the planimetric method for the same level of precision.

4.2 For specimens consisting of equiaxed grains, the method of comparing the specimen with a standard chart is most convenient and is sufficiently accurate for most commercial purposes. For higher degrees of accuracy in determining average grain size, the intercept or planimetric procedures may be used. The intercept procedure is particularly useful for structures consisting of elongated grains.

4.3 In case of dispute, the intercept procedure shall be the referee procedure in all cases.

4.4 No attempt should be made to estimate the average grain size of heavily cold-worked material. Partially recrystallized wrought alloys and lightly to moderately cold-worked material may be considered as consisting of non-equiaxed grains, if a grain size measurement is necessary.

4.5 *Individual grain measurements should not be made based on the standard comparison charts.* These charts were constructed to reflect the typical log-normal distribution of

grain sizes that result when a plane is passed through a three-dimensional array of grains. Because they show a distribution of grain dimensions, ranging from very small to very large, depending on the relationship of the planar section and the three-dimensional array of grains, the charts are not applicable to measurement of individual grains.

5. Generalities of Application

5.1 It is important, in using these test methods, to recognize that the estimation of average grain size is not a precise measurement. A metal structure is an aggregate of three-dimensional crystals of varying sizes and shapes. Even if all these crystals were identical in size and shape, the grain cross sections, produced by a random plane (surface of observation) through such a structure, would have a distribution of areas varying from a maximum value to zero, depending upon where the plane cuts each individual crystal. Clearly, no two fields of observation can be exactly the same.

5.2 The size and location of grains in a microstructure are normally completely random. No nominally random process of positioning a test pattern can improve this randomness, but random processes can yield poor representation by concentrating measurements in part of a specimen. *Representative* implies that all parts of the specimen contribute to the result, not, as sometimes has been presumed, that fields of average grain size are selected. Visual selection of fields, or casting out of extreme measurements, may not falsify the average when done by unbiased experts, but will in all cases give a false impression of high precision. For representative sampling, the area of the specimen is mentally divided into several equal coherent sub-areas and stage positions prespecified, which are approximately at the center of each sub-area. The stage is successively set to each of these positions and the test pattern applied blindly, that is, with the light out, the shutter closed, or the eye turned away. No touch-up of the position so selected is allowable. Only measurements made on fields chosen in this way can be validated with respect to precision and bias.

6. Sampling

6.1 Specimens should be selected to represent average conditions within a heat lot, treatment lot, or product, or to assess variations anticipated across or along a product or component, depending on the nature of the material being tested and the purpose of the study. Sampling location and frequency should be based upon agreements between the manufacturers and the users.

6.2 Specimens should not be taken from areas affected by shearing, burning, or other processes that will alter the grain structure.

7. Test Specimens

7.1 In general, if the grain structure is equiaxed, any specimen orientation is acceptable. However, the presence of an equiaxed grain structure in a wrought specimen can only be determined by examination of a plane of polish parallel to the deformation axis.

7.2 If the grain structure on a longitudinally oriented specimen is equiaxed, then grain size measurements on this plane, or

any other, will be equivalent within the statistical precision of the test method. If the grain structure is not equiaxed, but elongated, then grain size measurements on specimens with different orientations will vary. In this case, the grain size should be evaluated on at least two of the three principle planes, transverse, longitudinal, and planar (or radial and transverse for round bar) and averaged as described in Section 16 to obtain the mean grain size. If directed test lines are used, rather than test circles, intercept counts on non-equiaxed grains in plate or sheet type specimens can be made using only two principle test planes, rather than all three as required for the planimetric method.

7.3 The surface to be polished should be large enough in area to permit measurement of at least five fields at the desired magnification. In most cases, except for thin sheet or wire specimens, a minimum polished surface area of 160 mm² (0.25 in.²) is adequate.

7.4 The specimen shall be sectioned, mounted (if necessary), ground, and polished according to the recommended procedures in Practice E 3. The specimen shall be etched using a reagent, such as listed in Practice E 407, to delineate most, or all, of the grain boundaries (see also Annex A3).

TABLE 1 Suggested Comparison Charts for Metallic Materials

NOTE 1—These suggestions are based upon the customary practices in industry. For specimens prepared according to special techniques, the appropriate comparison standards should be selected on a structural-appearance basis in accordance with 8.2.

Material	Plate Number	Basic Magnification
Aluminum	I	100X
Copper and copper-base alloys (see Annex A4)	III or IV	75X, 100X
Iron and steel:		
Austenitic	II or IV	100X
Ferritic	I	100X
Carburized	IV	100X
Stainless	II	100X
Magnesium and magnesium-base alloys	I or II	100X
Nickel and nickel-base alloys	II	100X
Super-strength alloys	I or II	100X
Zinc and zinc-base alloys	I or II	100X

8. Calibration

8.1 Use a stage micrometer to determine the true linear magnification for each objective, eyepiece and bellows, or zoom setting to be used within $\pm 2\%$.

8.2 Use a ruler with a millimetre scale to determine the actual length of straight test lines or the diameter of test circles used as grids.

9. Preparation of Photomicrographs

9.1 When photomicrographs are used for estimating the average grain size, they shall be prepared in accordance with Guide E 883.

10. Comparison Procedure

10.1 The comparison procedure shall apply to completely recrystallized or cast materials with equiaxed grains.

10.2 When grain size estimations are made by the more convenient comparison method, repeated checks by individuals as well as by interlaboratory tests have shown that unless the appearance of the standard reasonably well approaches that of the sample, errors may occur. To minimize such errors, the comparison charts are presented in four categories as follows:⁴

10.2.1 *Plate I*—Untwinned grains (flat etch). Includes grain size numbers 00, 0, ½, 1, 1½, 2, 2½, 3, 3½, 4, 4½, 5, 5½, 6, 6½, 7, 7½, 8, 8½, 9, 9½, 10, at 100X.

10.2.2 *Plate II*—Twinned grains (flat etch). Includes grain size numbers, 1, 2, 3, 4, 5, 6, 7, 8, at 100X.

10.2.3 *Plate III*—Twinned grains (contrast etch). Includes nominal grain diameters of 0.200, 0.150, 0.120, 0.090, 0.070, 0.060, 0.050, 0.045, 0.035, 0.025, 0.020, 0.015, 0.010, 0.005 mm at 75X.

10.2.4 *Plate IV*—Austenite grains in steel (McQuaid-Ehn). Includes grain size numbers 1, 2, 3, 4, 5, 6, 7, 8, at 100X.

10.3 Table 1 lists a number of materials and the comparison charts that are suggested for use in estimating their average grain sizes. For example, for twinned copper and brass with a contrast etch, use Plate III.

NOTE 1—Examples of grain-size standards from Plates I, II, III, and IV are shown in Fig. 1, Fig. 2, Fig. 3, and Fig. 4.

10.4 The estimation of microscopically-determined grain size should usually be made by direct comparison at the same magnification as the appropriate chart. Accomplish this by comparing a projected image or a photomicrograph of a

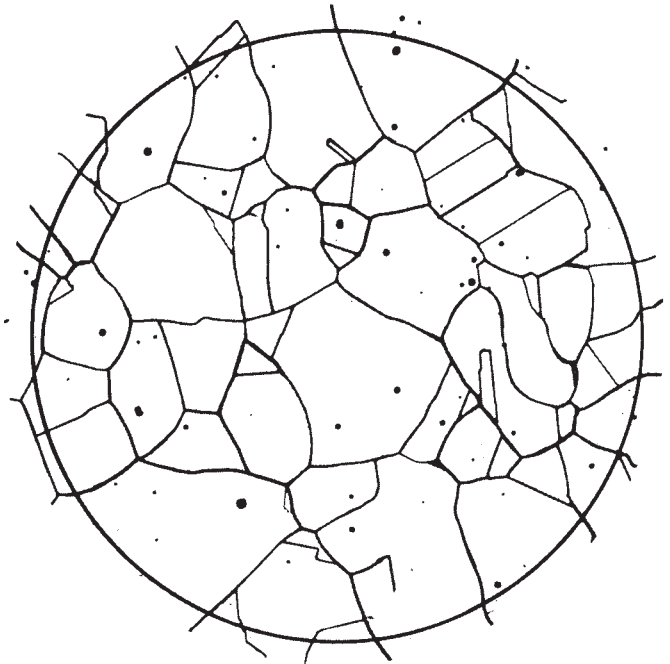

FIG. 2 Example of Twin Grains (Flat Etch) from Plate II. Grain Size No. 3 at 100X



FIG. 3 Example of Twin Grains (Contrast Etch) from Plate III. Grain Size 0.090 mm at 75X

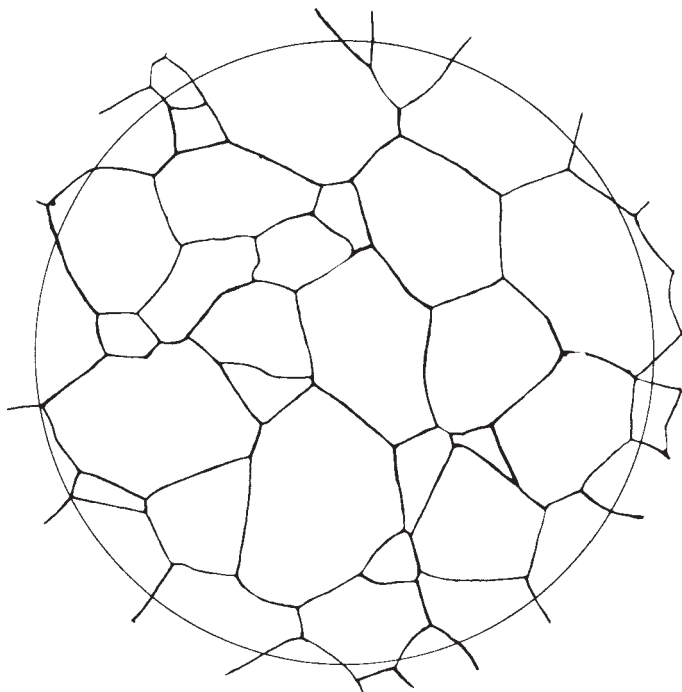

FIG. 1 Example of Untwinned Grains (Flat Etch) from Plate I. Grain Size No. 3 at 100X

⁴ Plates I, II, III, and IV are available from ASTM Headquarters. Order Adjunct: ADJE011201 (Plate I), ADJE011202 (Plate II), ADJE011203 (Plate III), and ADJE011204 (Plate IV). A combination of all four plates is also available. Order Adjunct: ADJE11214.

representative field of the test specimen with the photomicrographs of the appropriate standard grain-size series, or with suitable reproductions or transparencies of them, and select the photomicrograph which most nearly matches the image of the test specimen or interpolate between two standards. Report this estimated grain size as the ASTM grain size number, or grain diameter, of the chart picture that most closely matches the

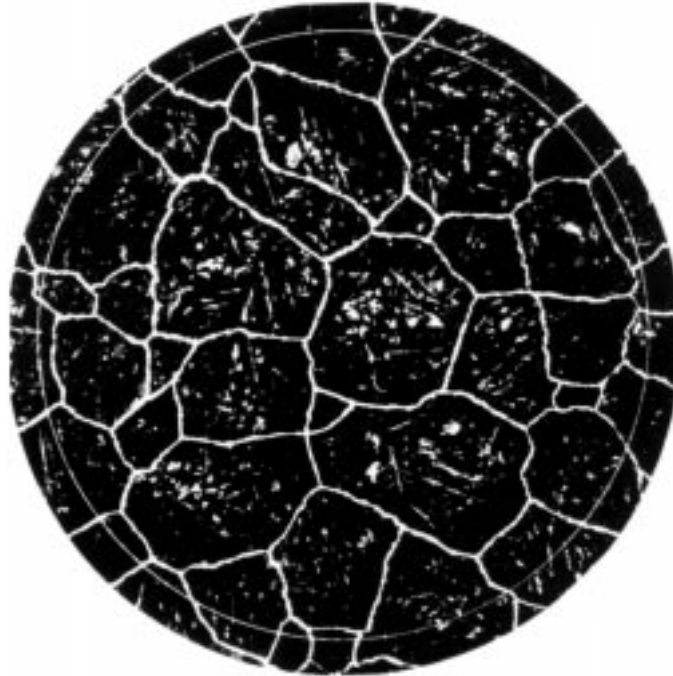

FIG. 4 Example of Austenite Grains in Steel from Plate IV. Grain Size No. 3 at 100X

image of the test specimen or as an interpolated value between two standard chart pictures.

10.7 When the grains are of a size outside the range covered by the standard photographs, or when magnifications of 75X or

TABLE 2 Microscopically Determined Grain Size Relationships Using Plate III at Various Magnifications

NOTE 1—First line—mean grain diameter, *d*, in mm; in parentheses—equivalent ASTM grain size number, *G*.
NOTE 2—Magnification for Plate III is 75X (row 3 data).

Magnification	Chart Picture Number (Plate III)													
	1	2	3	4	5	6	7	8	9	10	11	12	13	14
25X	0.015 (9.2)	0.030 (7.2)	0.045 (6.0)	0.060 (5.2)	0.075 (4.5)	0.105 (3.6)	0.135 (2.8)	0.150 (2.5)	0.180 (2.0)	0.210 (1.6)	0.270 (0.8)	0.360 (0)	0.451 (0/00)	0.600 (00 +)
50X	0.0075 (11.2)	0.015 (9.2)	0.0225 (8.0)	0.030 (7.2)	0.0375 (6.5)	0.053 (5.6)	0.0675 (4.8)	0.075 (4.5)	0.090 (4.0)	0.105 (3.6)	0.135 (2.8)	0.180 (2.0)	0.225 (1.4)	0.300 (0.5)
75X	0.005 (12.3)	0.010 (10.3)	0.015 (9.2)	0.020 (8.3)	0.025 (7.7)	0.035 (6.7)	0.045 (6.0)	0.050 (5.7)	0.060 (5.2)	0.070 (4.7)	0.090 (4.0)	0.120 (3.2)	0.150 (2.5)	0.200 (1.7)
100X	0.00375 (13.2)	0.0075 (11.2)	0.0112 (10.0)	0.015 (9.2)	0.019 (8.5)	0.026 (7.6)	0.034 (6.8)	0.0375 (6.5)	0.045 (6.0)	0.053 (5.6)	0.067 (4.8)	0.090 (4.0)	0.113 (3.4)	0.150 (2.5)
200X	0.0019 (15.2)	0.00375 (13.2)	0.0056 (12.0)	0.0075 (11.2)	0.009 (10.5)	0.013 (9.6)	0.017 (8.8)	0.019 (8.5)	0.0225 (8.0)	0.026 (7.6)	0.034 (6.8)	0.045 (6.0)	0.056 (5.4)	0.075 (4.5)
400X	—	0.0025 (14.3)	0.0037 (13.2)	0.005 (12.3)	0.006 (11.7)	0.009 (10.7)	0.011 (10.0)	0.0125 (9.7)	0.015 (9.2)	0.0175 (8.7)	0.0225 (8.0)	0.030 (7.2)	0.0375 (6.5)	0.050 (5.7)
500X	—	—	0.003 (13.8)	0.004 (13.0)	0.005 (12.3)	0.007 (11.4)	0.009 (10.6)	0.010 (10.3)	0.012 (9.8)	0.014 (9.4)	0.018 (8.6)	0.024 (7.8)	0.030 (7.2)	0.040 (6.3)

10.5 Good judgment on the part of the observer is necessary to select the magnification to be used, the proper size of area (number of grains), and the number and location in the specimen of representative sections and fields for estimating the characteristic or average grain size. It is not sufficient to visually select what appear to be areas of average grain size. Recommendations for choosing appropriate areas for all procedures have been noted in 5.2.

10.6 Grain size estimations shall be made on three or more representative areas of each specimen section.

100X are not satisfactory, other magnifications may be employed for comparison by using the relationships given in Note 2 and Table 2. It may be noted that alternative magnifications are usually simple multiples of the basic magnifications.

NOTE 2—If the grain size is reported in ASTM numbers, it is convenient to use the relationship:

$$Q = 2 \log_2(M/M_b) \tag{2}$$

$$= 6.64 \log_{10}(M/M_b)$$

where *Q* is a correction factor that is added to the apparent micro-grain

size of the specimen, as viewed at the magnification, M , instead of at the basic magnification, M_b (75X or 100X), to yield the true ASTM grain-size number. Thus, for a magnification of 25X, the true ASTM grain-size number is four numbers lower than that of the corresponding photomicrograph at 100X ($Q = -4$). Likewise, for 400X, the true ASTM grain-size number is four numbers higher ($Q = +4$) than that of the corresponding photomicrograph at 100X. Similarly, for 300X, the true ASTM grain-size number is four numbers higher than that of the corresponding photomicrograph at 75X.

10.8 The small number of grains per field at the coarse end of the chart series, that is, size 00, and the very small size of the grains at the fine end make accurate comparison ratings difficult. When the specimen grain size falls at either end of the chart range, a more meaningful comparison can be made by changing the magnification so that the grain size lies closer to the center of the range.

10.9 The use of transparencies⁵ or prints of the standards, with the standard and the unknown placed adjacent to each other, is to be preferred to the use of wall chart comparison with the projected image on the microscope screen.

10.10 No particular significance should be attached to the fact that different observers often obtain slightly different results, provided the different results fall within the confidence limits reasonably expected with the procedure used.

10.11 There is a possibility when an operator makes repeated checks on the same specimen using the comparison method that they will be prejudiced by their first estimate. This disadvantage can be overcome, when necessary, by changes in magnification, through bellows extension, or objective or eyepiece replacement between estimates (1).⁶

10.12 Make the estimation of macroscopically-determined grain sizes (extremely coarse) by direct comparison, at a magnification of 1X, of the properly prepared specimen, or of a photograph of a representative field of the specimen, with photographs of the standard grain series shown in Plate I (for untwinned material) and Plates II and III (for twinned material). Since the photographs of the standard grain size series were made at 75 and 100 diameters magnification, grain sizes estimated in this way do not fall in the standard ASTM grain-size series and hence, preferably, should be expressed either as diameter of the average grain or as one of the macro-grain size numbers listed in Table 3. For the smaller macroscopic grain sizes, it may be preferable to use a higher magnification and the correction factor given in Note 3, particularly if it is desirable to retain this method of reporting.

NOTE 3—If the grain size is reported in ASTM macro-grain size numbers, it is convenient to use the relationship:

⁵ Transparencies of the various grain sizes in Plate I are available from ASTM Headquarters. Order Adjunct: ADJE112010 for the set. Transparencies of individual grain size groupings are available on request. Order Adjunct: ADJE011205 (Grain Size 00), ADJE012206 (Grain Size 0), ADJE012207 (Grain Size 0.5), ADJE011208 (Grain Size 1.0), ADJE011209 (Grain Size 1.5), ADJE11210 (Grain Size 2.0), ADJE011211 (Grain Size 2.5), ADJE011212 (Grain Sizes 3.0, 3.5, and 4.0), ADJE011213 (Grain Sizes 4.5, 5.0, and 5.5), ADJE011214 (Grain Sizes 6.0, 6.5, and 7.0), ADJE011215 (Grain Sizes 7.5, 8.0, and 8.5), and ADJE011216 (Grain Sizes 9.0, 9.5, and 10.0). Charts illustrating grain size numbers 00 to 10 are on 8½ by 11 in. (215.9 by 279.4 mm) film. Transparencies for Plates II, III, and IV are not available.

⁶ The boldface numbers in parentheses refer to the list of references appended to these test methods.

$$Q_m = 2 \log_2 M \quad (3)$$

$$= 6.64 \log_{10} M$$

where Q_M is a correction factor that is added to the apparent grain size of the specimen, when viewed at the magnification M , instead of at 1X, to yield the true ASTM macro-grain size number. Thus, for a magnification of 2X, the true ASTM macro-grain size number is two numbers higher ($Q = +2$), and for 4X, the true ASTM macro-grain size number is four numbers higher ($Q = +4$) than that of the corresponding photograph.

10.13 The comparison procedure shall be applicable for estimating the austenite grain size in ferritic steel after a McQuaid-Ehn test (see Annex A3, A3.2), or after the austenite grains have been revealed by any other means (see Annex A3, A3.3). Make the grain-size measurement by comparing the microscopic image, at magnification of 100X, with the standard grain size chart in Plate IV, for grains developed in a McQuaid-Ehn test (see Annex A3); for the measurement of austenite grains developed by other means (see Annex A3), measure by comparing the microscopic image with the plate having the most nearly comparable structure observed in Plates I, II, or IV.

10.14 The so-called “Shepherd Fracture Grain Size Method” of judging grain size from the appearance of the fracture of hardened steel (2), involves comparison of the specimen under investigation with a set of standard fractures.⁷ It has been found that the arbitrarily numbered fracture grain size series agree well with the correspondingly numbered ASTM grain sizes presented in Table 4. This coincidence makes the fracture grain sizes interchangeable with the austenitic grain sizes determined microscopically. The sizes observed microscopically shall be considered the primary standard, since they can be determined with measuring instruments.

11. Planimetric (or Jeffries’) (3) Procedure

11.1 In the planimetric procedure inscribe a circle⁸ or rectangle of known area (usually 5000 mm² to simplify the calculations) on a micrograph or on the ground-glass screen of the metallograph. Select a magnification which will give at least 50 grains in the field to be counted. When the image is focused properly, count the number of grains within this area. The sum of all the grains included completely within the known area plus one half the number of grains intersected by the circumference of the area gives the number of equivalent whole grains, measured at the magnification used, within the area. If this number is multiplied by the Jeffries’ multiplier, f , in the second column of Table 5 opposite the appropriate magnification, the product will be the number of grains per square millimetre N_A . Count a minimum of three fields to ensure a reasonable average. The number of grains per square millimetre at 1X, N_A , is calculated from:

$$N_A = f \left(N_{\text{Inside}} + \frac{N_{\text{Intercepted}}}{2} \right) \quad (4)$$

⁷ A photograph of the Shepherd standard fractures can be obtained from ASTM Headquarters. Order Adjunct: ADJE011224.

⁸ A transparent grid for the planimetric method is available from ASTM Headquarters. The transparency consists of two test circles, one with a diameter of 79.8 mm (5000 mm² area) and the other with a diameter of 159.6 mm (20 000 mm² area). Order Adjunct: ADJE011223.

TABLE 4 Grain Size Relationships Computed for Uniform, Randomly Oriented, Equiaxed Grains

Grain Size No. <i>G</i>	\bar{N}_A Grains/Unit Area		\bar{A} Average Grain Area		\bar{d} Average Diameter		\bar{T} Mean Intercept		\bar{N}_L No./mm
	No./in. ² at 100X	No./mm ² at 1X	mm ²	µm ²	mm	µm	mm	µm	
00	0.25	3.88	0.2581	258064	0.5080	508.0	0.4525	452.5	2.21
0	0.50	7.75	0.1290	129032	0.3592	359.2	0.3200	320.0	3.12
0.5	0.71	10.96	0.0912	91239	0.3021	302.1	0.2691	269.1	3.72
1.0	1.00	15.50	0.0645	64516	0.2540	254.0	0.2263	226.3	4.42
1.5	1.41	21.92	0.0456	45620	0.2136	213.6	0.1903	190.3	5.26
2.0	2.00	31.00	0.0323	32258	0.1796	179.6	0.1600	160.0	6.25
2.5	2.83	43.84	0.0228	22810	0.1510	151.0	0.1345	134.5	7.43
3.0	4.00	62.00	0.0161	16129	0.1270	127.0	0.1131	113.1	8.84
3.5	5.66	87.68	0.0114	11405	0.1068	106.8	0.0951	95.1	10.51
4.0	8.00	124.00	0.00806	8065	0.0898	89.8	0.0800	80.0	12.50
4.5	11.31	175.36	0.00570	5703	0.0755	75.5	0.0673	67.3	14.87
5.0	16.00	248.00	0.00403	4032	0.0635	63.5	0.0566	56.6	17.68
5.5	22.63	350.73	0.00285	2851	0.0534	53.4	0.0476	47.6	21.02
6.0	32.00	496.00	0.00202	2016	0.0449	44.9	0.0400	40.0	25.00
6.5	45.25	701.45	0.00143	1426	0.0378	37.8	0.0336	33.6	29.73
7.0	64.00	992.00	0.00101	1008	0.0318	31.8	0.0283	28.3	35.36
7.5	90.51	1402.9	0.00071	713	0.0267	26.7	0.0238	23.8	42.04
8.0	128.00	1984.0	0.00050	504	0.0225	22.5	0.0200	20.0	50.00
8.5	181.02	2805.8	0.00036	356	0.0189	18.9	0.0168	16.8	59.46
9.0	256.00	3968.0	0.00025	252	0.0159	15.9	0.0141	14.1	70.71
9.5	362.04	5611.6	0.00018	178	0.0133	13.3	0.0119	11.9	84.09
10.0	512.00	7936.0	0.00013	126	0.0112	11.2	0.0100	10.0	100.0
10.5	724.08	11223.2	0.000089	89.1	0.0094	9.4	0.0084	8.4	118.9
11.0	1024.00	15872.0	0.000063	63.0	0.0079	7.9	0.0071	7.1	141.4
11.5	1448.15	22446.4	0.000045	44.6	0.0067	6.7	0.0060	5.9	168.2
12.0	2048.00	31744.1	0.000032	31.5	0.0056	5.6	0.0050	5.0	200.0
12.5	2896.31	44892.9	0.000022	22.3	0.0047	4.7	0.0042	4.2	237.8
13.0	4096.00	63488.1	0.000016	15.8	0.0040	4.0	0.0035	3.5	282.8
13.5	5792.62	89785.8	0.000011	11.1	0.0033	3.3	0.0030	3.0	336.4
14.0	8192.00	126976.3	0.000008	7.9	0.0028	2.8	0.0025	2.5	400.0

TABLE 5 Relationship Between Magnification Used and Jeffries' Multiplier, *f*, for an Area of 5000 mm² (a Circle of 79.8-mm Diameter) (*f* = 0.0002 *M*²)

Magnification Used, <i>M</i>	Jeffries' Multiplier, <i>f</i> , to Obtain Grains/mm ²
1	0.0002
10	0.02
25	0.125
50	0.5
75 ^A	1.125
100	2.0
150	4.5
200	8.0
250	12.5
300	18.0
500	50.0
750	112.5
1000	200.0

^A At 75 diameters magnification, Jeffries' multiplier, *f*, becomes unity if the area used is 5625 mm² (a circle of 84.5-mm diameter).

where *f* is the Jeffries' multiplier (see Table 5), N_{Inside} is the number of grains completely inside the test circle and $N_{\text{Intercepted}}$ is the number of grains that intercept the test circle. The average grain area, \bar{A} , is the reciprocal of N_A , that is, $1/N_A$, while the mean grain diameter, \bar{d} , as listed on Plate III (see 10.2.3), is the square root of \bar{A} . This grain diameter has no physical significance because it represents the side of a square grain of area \bar{A} , and grain cross sections are not square.

11.2 To obtain an accurate count of the number of grains completely within the test circle and the number of grains intersecting the circle, it is necessary to mark off the grains on the template, for example, with a grease pencil or felt tip pen. The precision of the planimetric method is a function of the number of grains counted (see Section 19). The number of

grains within the test circle, however, should not exceed about 100 as counting becomes tedious and inaccurate. Experience suggests that a magnification that produces about 50 grains within the test circle is about optimum as to counting accuracy per field. Because of the need to mark off the grains to obtain an accurate count, the planimetric method is less efficient than the intercept method (see Section 12).

11.3 Fields should be chosen at random, without bias, as described in 5.2. Do not attempt to choose fields that appear to be typical. Choose the fields blindly and select them from different locations on the plane of polish.

11.4 By original definition, a microscopically-determined grain size of No. 1 has 1.000 grains/in.² at 100X, hence 15.500 grains/mm² at 1X. For areas other than the standard circle, determine the actual number of grains per square millimetre, N_A , and find the nearest size from Table 4. The ASTM grain size number, *G*, can be calculated from N_A (number of grains per mm² at 1X) using (Eq 1) in Table 6.

12. General Intercept Procedures

12.1 Intercept procedures are more convenient to use than the planimetric procedure. These procedures are amenable to use with various types of machine aids. It is strongly recommended that at least a manual tally counter be used with all intercept procedures in order to prevent normal errors in counting and to eliminate bias which may occur when counts appear to be running higher or lower than anticipated.

12.2 Intercept procedures are recommended particularly for all structures that depart from the uniform equiaxed form. For anisotropic structures, procedures are available either to make

TABLE 6 Grain Size Equations Relating Measured Parameters to the Microscopically Determined ASTM Grain Size, G

NOTE 1—Determine the ASTM Grain Size, G , using the following equations:

NOTE 2—The second and third equations are for single phase grain structures.

NOTE 3—To convert micrometres to millimetres, divide by 1000.

NOTE 4—A calculated G value of -1 corresponds to ASTM $G = 00$.

Equation	Units
$G = (3.321928 \log_{10} \bar{N}_A) - 2.954$	N_A in mm^{-2}
$G = (6.643856 \log_{10} \bar{N}_L) - 3.288$	\bar{N}_L in mm^{-1}
$G = (6.643856 \log_{10} P_L) - 3.288$	P_L in mm^{-1}
$G = (-6.643856 \log_{10} \ell) - 3.288$	ℓ in mm

between the mean lineal intercept, ℓ , and the average grain area, \bar{A} , is exact for circles but not quite exact for a structure of uniform equiaxed grains (see A2.2.2). Consequently, the relationship between the ASTM grain size number G and the mean lineal intercept has been defined so that ASTM No. 0 has a mean intercept size of precisely 32.00 mm for the microscopically determined grain size scale and of 32.00 mm on a field of view at 100X magnification for the microscopically determined grain size scale. Thus:

$$G = 2 \log_2 \frac{\ell_0}{\ell} \quad (6)$$

TABLE 3 Macroscopic Grain Size Relationships Computed for Uniform, Randomly Oriented, Equiaxed Grains

NOTE 1—Macroscopically determined grain size numbers M-12.3, M-13.3, M-13.8 and M-14.3 correspond, respectively, to microscopically determined grain size numbers (G) 00, 0, 0.5 and 1.0.

Macro Grain Size No.	\bar{N}_A Grains/Unit Area		\bar{A} Average Grain Area		\bar{d} Average Diameter		$\bar{\ell}$ Mean Intercept		\bar{N}_L mm ⁻¹	\bar{N} 100 mm
	No./mm ²	No./in. ²	mm ²	in. ²	mm	in.	mm	in.		
M-0	0.0008	0.50	1290.3	2.00	35.9	1.41	32.00	1.2	0.031	3.13
M-0.5	0.0011	0.71	912.4	1.41	30.2	1.19	26.91	1.0	0.037	3.72
M-1.0	0.0016	1.00	645.2	1.00	25.4	1.00	22.63	0.89	0.044	4.42
M-1.5	0.0022	1.41	456.2	0.707	21.4	0.841	19.03	0.74	0.053	5.26
M-2.0	0.0031	2.00	322.6	0.500	18.0	0.707	16.00	0.63	0.063	6.25
M-2.5	0.0044	2.83	228.1	0.354	15.1	0.595	13.45	0.53	0.074	7.43
M-3.0	0.0062	4.00	161.3	0.250	12.7	0.500	11.31	0.44	0.088	8.84
M-3.5	0.0088	5.66	114.0	0.177	10.7	0.420	9.51	0.37	0.105	10.51
M-4.0	0.0124	8.00	80.64	0.125	8.98	0.354	8.00	0.31	0.125	12.50
M-4.5	0.0175	11.31	57.02	0.0884	7.55	0.297	6.73	0.26	0.149	14.87
M-5.0	0.0248	16.00	40.32	0.0625	6.35	0.250	5.66	0.22	0.177	17.68
M-5.5	0.0351	22.63	28.51	0.0442	5.34	0.210	4.76	0.18	0.210	21.02
M-6.0	0.0496	32.00	20.16	0.0312	4.49	0.177	4.00	0.15	0.250	25.00
M-6.5	0.0701	45.26	14.26	0.0221	3.78	0.149	3.36	0.13	0.297	29.73
M-7.0	0.099	64.00	10.08	0.0156	3.17	0.125	2.83	0.11	0.354	35.36
M-7.5	0.140	90.51	7.13	0.0110	2.67	0.105	2.38	0.093	0.420	42.05
				$\times 10^{-3}$		$\times 10^{-3}$		$\times 10^{-3}$		
M-8.0	0.198	128.0	5.04	7.812	2.25	88.4	2.00	78.7	0.500	50.00
M-8.5	0.281	181.0	3.56	5.524	1.89	74.3	1.68	66.2	0.595	59.46
M-9.0	0.397	256.0	2.52	3.906	1.59	62.5	1.41	55.7	0.707	70.71
M-9.5	0.561	362.1	1.78	2.762	1.33	52.6	1.19	46.8	0.841	84.09
M-10.0	0.794	512.0	1.26	1.953	1.12	44.2	1.00	39.4	1.00	100.0
M-10.5	1.122	724.1	0.891	1.381	0.994	37.2	0.841	33.1	1.19	118.9
M-11.0	1.587	1024.1	0.630	0.977	0.794	31.2	0.707	27.8	1.41	141.4
M-11.5	2.245	1448.2	0.445	0.690	0.667	26.3	0.595	23.4	1.68	168.2
M-12.0	3.175	2048.1	0.315	0.488	0.561	22.1	0.500	19.7	2.00	200.0
M-12.3	3.908	2521.6	0.256	0.397	0.506	19.9	0.451	17.7	2.22	221.9
M-12.5	4.490	2896.5	0.223	0.345	0.472	18.6	0.420	16.6	2.38	237.8
M-13.0	6.349	4096.3	0.157	0.244	0.397	15.6	0.354	13.9	2.83	282.8
M-13.3	7.817	5043.1	0.128	0.198	0.358	14.1	0.319	12.5	3.14	313.8
M-13.5	8.979	5793.0	0.111	0.173	0.334	13.1	0.297	11.7	3.36	336.4
M-13.8	11.055	7132.1	0.091	0.140	0.301	11.8	0.268	10.5	3.73	373.2
M-14.0	12.699	8192.6	0.079	0.122	0.281	11.0	0.250	9.84	4.00	400.0
M-14.3	15.634	10086.3	0.064	0.099	0.253	9.96	0.225	8.87	4.44	443.8

separate size estimates in each of the three principal directions, or to rationally estimate the average size, as may be appropriate.

12.3 There is no direct mathematical relationship between the ASTM grain size number, G , and the mean lineal intercept, unlike the exact relationship between G , N_{AE} , N_A and \bar{A} (Eq 1) for the planimetric method. The relationship

$$\ell = \left(\frac{\pi}{4} \bar{A} \right)^{1/2} \quad (5)$$

$$G = 10.00 - 2 \log_2 \ell \quad (7)$$

$$G = 10.00 + 2 \log_2 \bar{N}_L \quad (8)$$

where ℓ_0 is 32 mm and $\bar{\ell}$ and \bar{N}_L are in millimetres at 1X or number of intercepts per mm for the macroscopically determined grain size numbers and in millimetres or number per mm on a field at 100X for the microscopically determined grain size numbers. Using this scale, measured grain size numbers are within about 0.01 G units of grain size numbers

determined by the planimetric method, that is, well within the precision of the test methods. Additional details concerning grain size relationships are given in Annex A1 and Annex A2.

12.4 The mean intercept distance, $\bar{\ell}$, measured on a plane section is an unbiased estimate of the mean intercept distance within the solid material in the direction, or over the range of directions, measured. The grain boundary surface area-to-volume ratio is given exactly by $S_v = 2N_L$ when N_L is averaged over three dimensions. These relations are independent of grain shape.

13. Heyn (4) Lineal Intercept Procedure

13.1 Estimate the average grain size by counting (on the ground-glass screen, on a photomicrograph of a representative field of the specimen, or on the specimen itself) the number of grains intercepted by one or more straight lines sufficiently long to yield at least 50 intercepts. It is desirable to select a combination of test line length and magnification such that a single field will yield the required number of intercepts. One such test will nominally allow estimation of grain size to the nearest whole ASTM size number, at the location tested. Additional lines, in a predetermined array, should be counted to obtain the precision required. The precision of grain size estimates by the intercept method is a function of the number of grain interceptions counted (see Section 19). Because the ends of straight test lines will usually lie inside grains (see 14.3), precision will be reduced if the average count per test line is low. If possible, use either a longer test line or a lower magnification.

13.2 Make counts first on three to five blindly selected and widely separated fields to obtain a reasonable average for the specimen. If the apparent precision of this average (calculated

as indicated in Section 15) is not adequate, make counts on sufficient additional fields to obtain the precision required for the specimen average.

13.3 An *intercept* is a segment of test line overlaying one grain. An *intersection* is a point where a test line is cut by a grain boundary. Either may be counted, with identical results in a single phase material. When counting intercepts, segments at the end of a test line which penetrate into a grain are scored as half intercepts. When counting intersections, the end points of a test line are not intersections and are not counted except when the end appears to exactly touch a grain boundary, when $\frac{1}{2}$ intersection should be scored. A tangential intersection with a grain boundary should be scored as one intersection. An intersection apparently coinciding with the junction of three grains should be scored as $1\frac{1}{2}$. With irregular grain shapes, the test line may generate two intersections with different parts of the same grain, together with a third intersection with the intruding grain. The two additional intersections are to be counted.

13.4 The effects of moderate departure from an equiaxed structure may be eliminated by making intercept counts on a line array containing lines having four or more orientations. The four straight lines of Fig. 5⁹ may be used. The form of such arrays is not critical, provided that all portions of the field are measured with approximately equal weight. An array of lines radiating from a common point is therefore not suitable. The number of intercepts is to be counted for the entire array and single values of N_L and $\bar{\ell}$ determined for each array as a whole.

⁹ A true-size transparency of Fig. 5 is available from ASTM Headquarters. Order Adjunct:ADJE011217.

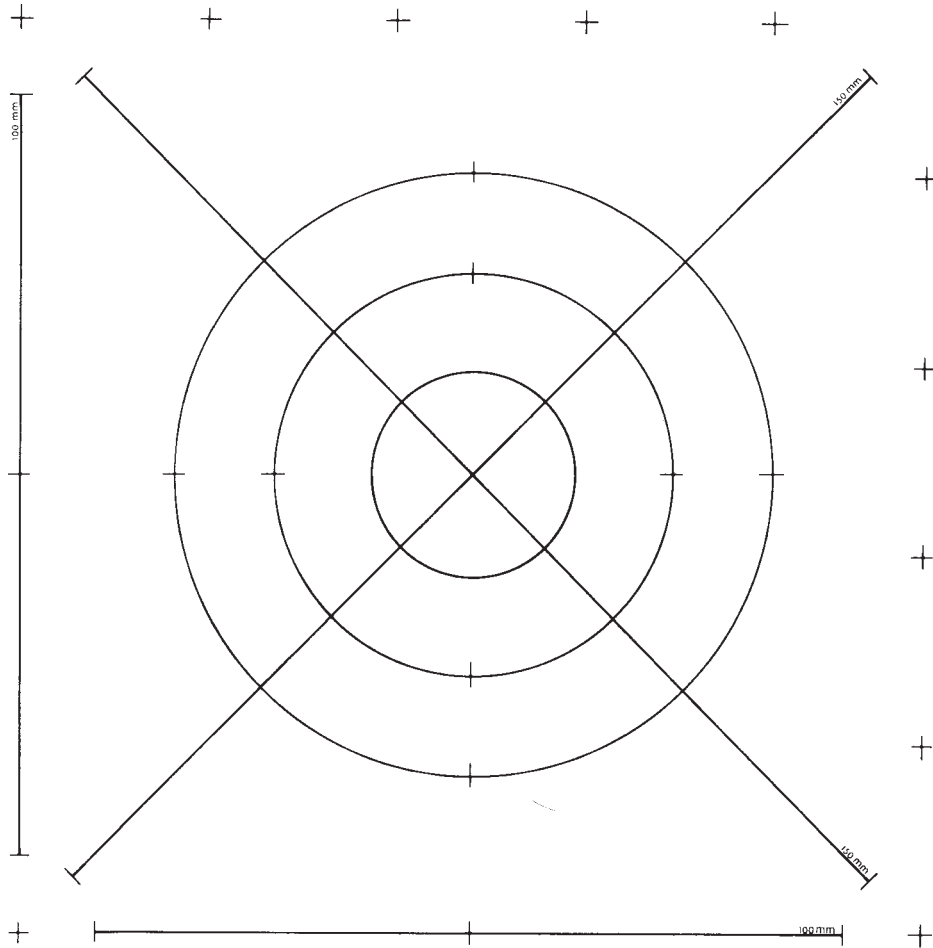

NOTE 1—If reproduced to make straight lines marked length:
Straight lines total: 500 mm

Circles are:	Circumference, mm,	Diameter, mm
	250.0	79.58
	166.7	53.05
	83.3	26.53
	<hr/>	
	Total 500.0	

NOTE 2—See Footnote 9.

FIG. 5 Test Pattern for Intercept Counting

13.5 For distinctly non-equiaxed structures such as moderately worked metals, more information can be obtained by making separate size determinations along parallel line arrays that coincide with all three principal directions of the specimen. Longitudinal and transverse specimen sections are normally used, the normal section being added when necessary. Either of the 100-mm lines of Fig. 5 may be applied five times, using parallel displacements, placing the five “+” marks at the same point on the image. Alternatively, a transparent test grid with systematically spaced parallel test lines of known length can be made and used.

14. Circular Intercept Procedures

14.1 Use of circular test lines rather than straight test lines has been advocated by Underwood (5), Hilliard (6), and Abrams (7). Circular test arrays automatically compensate for departures from equiaxed grain shapes, without overweighting

any local portion of the field. Ambiguous intersections at ends of test lines are eliminated. Circular intercept procedures are most suitable for use as fixed routine manual procedures for grain size estimation in quality control.

14.2 Hilliard Single-Circle Procedure (6) :

14.2.1 When the grain shape is not equiaxed but is distorted by deformation or other processes, obtaining an average lineal intercept value using straight test lines requires averaging of values made at a variety of orientations. If this is not done carefully, bias may be introduced. Use of a circle as the test line eliminates this problem as the circle will test all orientations equally and without bias.

14.2.2 Any circle size of exactly known circumference may be used. Circumferences of 100, 200, or 250 mm are usually convenient. The test circle diameter should never be smaller than the largest observed grains. If the test circle is smaller than about three times the mean lineal intercept, the distribution of

the number of intercepts or intersections per field will not be Gaussian. Also, use of small test circles is rather inefficient as a great many fields must be evaluated to obtain a high degree of precision. A small reference mark is usually placed at the top of the circle to indicate the place to start and stop the count. Blindly apply the selected circle to the microscope image at a convenient known magnification and count the number of grain boundaries intersecting the circle for each application. Apply the circle only once to each field of view, adding fields in a representative manner, until sufficient counts are obtained to yield the required precision. The variation in counts per test circle application decreases as the circle size increases and, of course, is affected by the uniformity of the grain size distribution.

14.2.3 As with all intercept procedures, the precision of the measurement increases as the number of counts increases (see Section 19). The precision is based on the standard deviation of the counts of the number of intercepts or intersections per field. In general, for a given grain structure, the standard deviation is improved as the count per circle application and the total count (that is, the number of applications) increase. Hilliard recommended test conditions that produce about 35 counts per circle with the test circle applied blindly over as large a specimen area as feasible until the desired total number of counts is obtained.

14.3 *Abrams Three-Circle Procedure (7) :*

14.3.1 Based on an experimental finding that a total of 500 counts per specimen normally yields acceptable precision, Abrams developed a specific procedure for routine average grain size rating of commercial steels. Use of the chi-square test on real data demonstrated that the variation of intercept counts is close to normal, allowing the observations to be treated by the statistics of normal distributions. Thus both a measure of variability and the confidence limit of the result are computed for each average grain size determination.

14.3.2 The test pattern consists of three concentric and equally spaced circles having a total circumference of 500 mm, as shown in Fig. 5. Successively apply this pattern to at least five blindly selected and widely spaced fields, separately recording the count of intersections per pattern for each of the tests. Then, determine the mean lineal intercept, its standard deviation, 95 % confidence limit, and percent relative accuracy. For most work, a relative accuracy of 10 % or less represents an acceptable degree of precision. If the calculated relative accuracy is unacceptable for the application, count additional fields until the calculated percent relative accuracy is acceptable. The specific procedure is as follows:

14.3.2.1 Examine the grain structure and select a magnification that will yield from 40 to 100 intercepts or intersection counts per placement of the three circle test grid. Because our goal is to obtain a total of about 400 to 500 counts, the ideal magnification is that which yields about 100 counts per placement. However, as the count per placement increases from 40 to 100, errors in counting become more likely. Because the grain structure will vary somewhat from field to field, at least five widely spaced fields should be selected. Some metallographers feel more comfortable counting 10 fields with about 40 to 50 counts per field. For most grain

structures, a total count of 400 to 500 intercepts or intersections over 5 to 10 fields produces better than 10 % relative accuracy. Fig. 6 shows the relationship between the average intercept count and the microscopically determined ASTM grain size number as a function of magnification.

14.3.2.2 Blindly select one field for measurement and apply the test pattern to the image. A transparency of the pattern may be applied directly to the ground glass, or to a photomicrograph when permanent records are desired. Direct counting using a properly sized reticle in the eyepiece is allowable, but it may here be expected that some operators will find difficulty in counting correctly at the count density recommended. Completely count each circle in turn, using a manually operated counter to accumulate the total number of grain boundary intersections with the test pattern. The manual counter is necessary to avoid bias toward unreal agreement between applications or toward a desired result, and to minimize memory errors. The operator should avoid keeping a mental score. When a tally counter is used, score any intersection of the circle with the junction of three grains as two rather than the correct value of 1½; the error introduced is very small.

14.3.3 For each field count, calculate N_L or P_L according to:

$$\bar{N}_L = \frac{N_i}{L/M} \tag{9}$$

$$\bar{P}_L = \frac{P_i}{L/M} \tag{10}$$

where N_i and P_i are the number of intercepts or intersections counted on the field, L is the total test line length (500 mm) and M is the magnification.

14.3.4 Calculate the mean lineal intercept value for each field, $\bar{\tau}$ by:

$$\bar{\tau} = \frac{1}{\bar{N}_L} = \frac{1}{\bar{P}_L} \tag{11}$$

The average value of n determinations of N_L , P_L , or $\bar{\tau}$ is used to determine the microscopically measured ASTM grain size using the equations in Table 6, the data shown graphically in Fig. 6, or the data in Table 4.

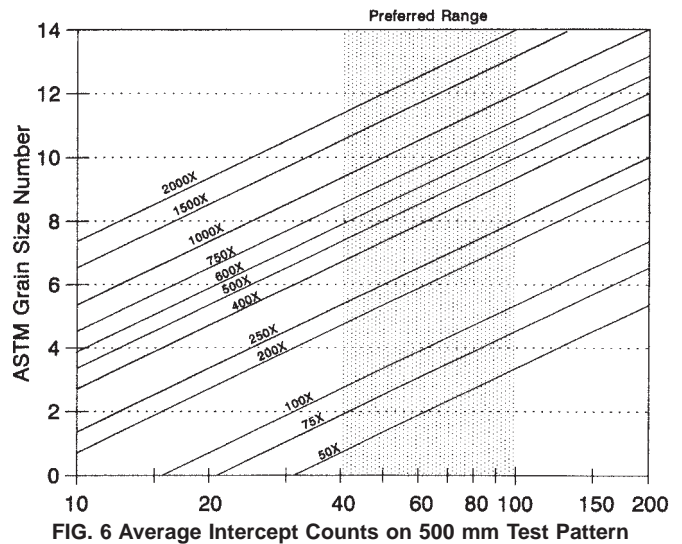

15. Statistical Analysis

15.1 No determination of average grain size can be an exact measurement. Thus, no determination is complete without also calculating the precision within which the determined size may, with normal confidence, be considered to represent the actual average grain size of the specimen examined. In accordance with common engineering practice, this section assumes normal confidence to represent the expectation that the actual error will be within the stated uncertainty 95 % of the time.

15.1.1 Many specimens vary measurably in grain size from one field of view to another, this variation being responsible for a major portion of the uncertainty. Minimum effort in manual methods, to obtain a required precision, justifies individual counts whose precision is comparable to this natural variability (6). The high local precision that may be obtained by machine methods often will yield only a small increase in overall precision unless many fields also are measured, but does help distinguish natural variability from inaccuracies of counting.

15.2 After the desired number of fields have been measured, calculate the mean value of \bar{N}_A or $\bar{\ell}$ from the individual field values according to:

$$\bar{X} = \frac{\sum X_i}{n} \quad (12)$$

where X_i represents an individual value, \bar{X} is the mean and n is the number of measurements.

15.3 Calculate the standard deviation of the individual measurements according to the usual equation:

$$s = \left[\frac{\sum (X_i - \bar{X})^2}{n - 1} \right]^{1/2} \quad (13)$$

where s is the standard deviation.

15.4 Calculate the 95 % confidence interval, 95 % CI, of each measurement according to:

$$95\% \text{ CI} = \frac{t \cdot s}{\sqrt{n}} \quad (14)$$

where the \cdot indicates a multiplication operation. Table 7 lists values of t as a function of n .

15.5 Calculate the percent relative accuracy, % RA, of the measurements by dividing the 95 % CI value by the mean and expressing the results as a percentage, that is:

$$\% \text{ RA} = \frac{95\% \text{ CI}}{\bar{X}} \cdot 100 \quad (15)$$

15.6 If the % RA is considered to be too high for the intended application, more fields should be measured and the

calculations in 15.1-15.5 should be repeated. As a general rule, a 10 % RA (or lower) is considered to be acceptable precision for most purposes.

15.7 Convert the mean value of \bar{N}_A or $\bar{\ell}$ to the ASTM grain size number, G , using Table 4 or the Eqs in Table 6.

16. Specimens with Non-equiaxed Grain Shapes

16.1 If the grain shape was altered by processing so that the grains are no longer equiaxed in shape, grain size measurements should be made on longitudinal (ℓ), transverse (t) and planar (p) oriented surfaces for rectangular bar, plate or sheet type material. For round bars, radial longitudinal and transverse sections are used. If the departure from equiaxed is not too great (see 16.2.2), a reasonable estimate of the grain size can be determined using a longitudinal specimen and the circular test grid. If directed test lines are used for the analysis, measurements in the three principal directions can be made using only two of the three principal test planes.

16.2 *Planimetric Method:*

16.2.1 When the grain shape is not equiaxed but elongated, make grain counts on each of the three principal planes, that is, planes of polish on longitudinal, transverse and planar-oriented surfaces. Determine the number of grains per mm^2 at 1X on the longitudinal, transverse, and planar oriented surfaces, $\bar{N}_{A\ell}$, \bar{N}_{At} and \bar{N}_{Ap} , respectively, and calculate the mean number of grains per unit area, \bar{N}_A , from the three \bar{N}_A values from the principal planes:

$$\bar{N} = (\bar{N}_{A\ell} \cdot \bar{N}_{At} \cdot \bar{N}_{Ap})^{1/3} \quad (16)$$

where \cdot indicates a multiplication operation and the bar above each quantity indicates an average value.

16.2.2 A reasonable estimate of the grain size can be made from $\bar{N}_{A\ell}$ alone if the departure from an equiaxed shape is not excessive ($\leq 3:1$ aspect ratio).

16.2.3 Calculate G from the mean value of \bar{N}_A from the averages made on each field. Perform the statistical analysis (15.1-15.5) only on the individual measurements on each field.

16.3 *Intercept Method:*

16.3.1 To assess the grain size of non-equiaxed grain structures, measurements can be made using circular test grids or randomly placed test lines on each of the three principal test planes, or by use of directed test lines in either three or six of the principal directions using either two or three of the principal test planes, see Fig. 7. For specimens where the departure from an equiaxed shape is not severe ($\leq 3:1$ aspect ratio), a reasonable estimate of the grain size can be made using a circular test grid on the longitudinal plane only.

16.3.2 The grain size can be determined from measurements of the mean number of grain boundary intersections per unit length, \bar{P}_L , or the mean number of grains intercepted per unit length, \bar{N}_L . Both methods yield the same results for a single phase grain structure. \bar{P}_L or \bar{N}_L can be determined using either test circles on each of the principal planes or directed test lines in either three or six of the principal test directions shown in Fig. 7.

16.3.3 For the case of randomly determined values of \bar{P}_L or \bar{N}_L on the three principal planes, compute the average value according to:

TABLE 7 95 % Confidence Internal Multipliers, t

No. of Fields, n	t	No. of Fields, n	t
5	2.776	13	2.179
6	2.571	14	2.160
7	2.447	15	2.145
8	2.365	16	2.131
9	2.306	17	2.120
10	2.262	18	2.110
11	2.228	19	2.101
12	2.201	20	2.093

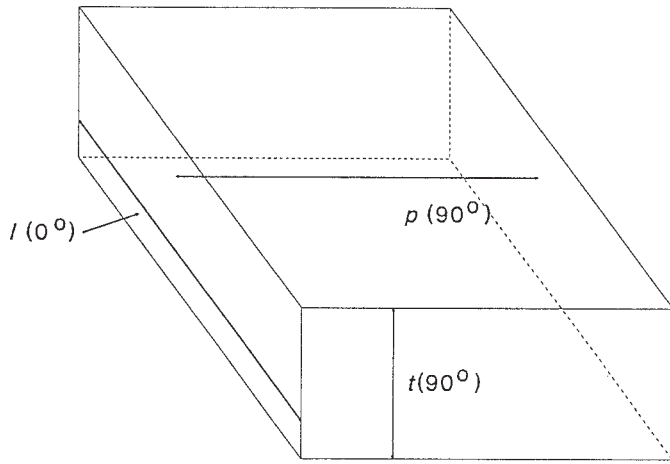

a. Principle directed test line orientations

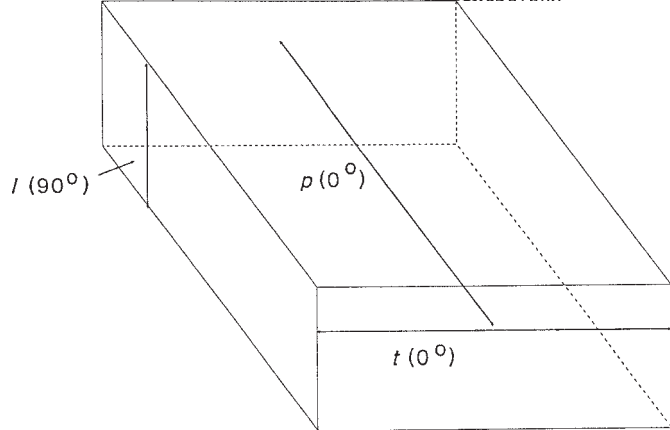

b. Alternate directed test line orientations

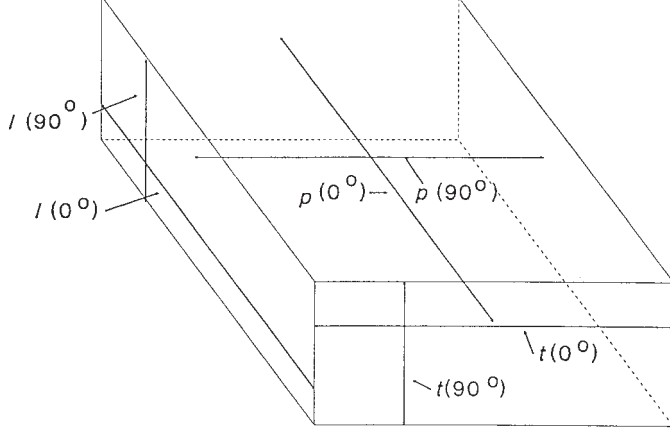

c. All six directed test line orientations

NOTE 1—Measurements of rectangular bar, plate, strip or sheet type specimens with non-equiaxed grain structures.

FIG. 7 Schematic Showing the Six Possible Directed Test Line Orientations for Grain Size Measurement

$$\bar{P} = (\bar{P}_{Ll} \cdot \bar{P}_{Lt} \cdot \bar{P}_{Lp})^{1/3} \quad (17)$$

or

$$\bar{N} = (\bar{N}_{Ll} \cdot \bar{N}_{Lt} \cdot \bar{N}_{Lp})^{1/3} \quad (18)$$

Alternatively, calculate ℓ_ℓ , $\bar{\ell}_l$ and $\bar{\ell}_p$ from the \bar{P}_L or \bar{N}_L values on each plane using (Eq 11). Then, calculate the overall mean value of $\bar{\ell}$ from:

$$\bar{\ell} = (\bar{\ell}_\ell \cdot \bar{\ell}_l \cdot \bar{\ell}_p)^{1/3} \quad (19)$$

16.3.4 If directed test lines are used in the principal directions on the principal planes, only two of the principal planes are required to perform directed counts in the three principal directions and obtain an estimate of the grain size.

16.3.5 Additional information on grain shape may be obtained by determining $\bar{\ell}$ parallel (0°) and perpendicular (90°) to the deformation axis on a longitudinally oriented surface. The grain elongation ratio, or the anisotropy index, AI , can be determined from:

$$AI_\ell = \bar{\ell}_{\ell(0^\circ)} / \bar{\ell}_{\ell(90^\circ)} \quad (20)$$

16.3.5.1 The three-dimensional mean grain size and shape may also be defined by the directed mean lineal intercept values on the three principal planes. These values would be expressed as:

$$\bar{\ell}_{\ell(0^\circ)} : \bar{\ell}_{\ell(90^\circ)} : \bar{\ell}_{\ell(90^\circ)} \quad (21)$$

16.3.5.2 Another approach that can be used is to normalize the three results by dividing each by the value of the smallest with the results expressed as ratios.

16.3.6 The mean value of $\bar{\ell}$ for the measurements in the three principal test directions is obtained by averaging the directed \bar{N}_L , or \bar{P}_L values (as shown in (Eq 22)) and then computing $\bar{\ell}$ from this mean value; or, by calculating directed $\bar{\ell}$ values in each of the three principal directions and then averaging them according to (Eq 23):

$$\bar{P} = (\bar{P}_{Ll(0^\circ)} \cdot \bar{P}_{Ll(90^\circ)} \cdot \bar{P}_{Lp(90^\circ)})^{1/3} \quad (22)$$

This is done in like manner for \bar{N}_L . For computing the grand mean $\bar{\ell}$ from the directed mean values, use:

$$\bar{\ell} = (\bar{\ell}_{\ell(0^\circ)} \cdot \bar{\ell}_{\ell(90^\circ)} \cdot \bar{\ell}_{\ell(90^\circ)})^{1/3} \quad (23)$$

where the \cdot indicates a multiplication operation.

16.3.7 The mean grain size is determined from the overall averages of \bar{P}_L , \bar{N}_L or ℓ using Table 4 or the equations in Table 6. Additional information on the measurement of grain size for non-equiaxed structures can be found in Annex A1 of Test Methods E 1382.

16.4 Statistical analysis should be performed on the data from each plane or each principal test direction according to the procedure in 15.1-15.5.

17. Specimens Containing Two or More Phases or Constituents

17.1 Minor amounts of second phase particles, whether desirable or undesirable features, may be ignored in the determination of grain size, that is, the structure is treated as a single phase material and the previously described planimetric or intercept methods are used to determine the grain size.

Unless stated otherwise, the effective average grain size shall be presumed to be the size of the matrix phase.

17.2 The identity of each measured phase and the percentage of field area occupied by each phase shall be determined and reported. The percentage of each phase can be determined according to Practice E 562.

17.3 *Comparison Method*—The comparison chart rating procedure may provide acceptable precision for most commercial applications if the second phase (or constituent) consists of *islands* or *patches* of essentially the same size as the matrix grains; or, the amount and size of the second phase particles are both small and the particles are located primarily along grain boundaries.

17.4 *Planimetric Method*—The planimetric method may be applied if the matrix grain boundaries are clearly visible and the second phase (constituent) particles are mainly present between the matrix grains rather than within the grains. Determine the percentage of the test area occupied by the second phase, for example, by Practice E 562. Always determine the amount of the phase of least concentration, usually the second phase or constituent. Then, determine the matrix phase by difference. Next, count the number of matrix grains completely within the test areas and the number of matrix grains intersecting the test area boundary, as described in Section 11. The test area must be reduced to that covered only by the matrix phase grains. The effective average grain size is then determined from the number of grains per unit net area of the matrix phase. Statistically analyze the number of grains per unit area of the α matrix phase, $N_A \alpha$, from each field measurement using the approach described in Section 15. Then, from the overall average, $\bar{N}_A \alpha$, determine the effective grain size of the matrix using Table 4 or the appropriate equation in Table 6.

17.5 *Intercept Method*—The same restrictions regarding applicability, as stated in 17.4, pertain to this method. Again, the amount of the matrix phase must be determined, as described in 17.4. A test grid consisting of one or more test circles, such as shown in Fig. 5, is used. For this application, count the number of matrix grains, N_α , intercepted by the test line. Determine the mean intercept length of the matrix phase according to:

$$\bar{\tau}_\alpha = \frac{(V_{V\alpha})(L/M)}{N_\alpha} \quad (24)$$

where the volume fraction of the α matrix, $V_{V\alpha}$, is expressed as a fraction, L is the test line length and M is the magnification. The grain size of the α grains is determined using Table 4 or the equation in Table 6. In practice, it is inconvenient to manually determine the volume fraction of the α phase and the number of α grains intercepting the test line for each field. If this is done, the mean lineal intercept length of the α phase for each field can be determined and this data can be statistically analyzed for each field according to the procedure described in Section 15. If $V_{V\alpha}$ and N_α are not measured simultaneously for the same fields, then the statistical analysis can only be performed on the $V_{V\alpha}$ and N_α data.

17.6 It is also possible to determine $\bar{\tau}_\alpha$ by measurement of individual intercept lengths using parallel straight test lines applied randomly to the structure. Do not measure the partial

intercepts at the ends of the test lines. This method is rather tedious unless it can be automated in some way. The individual intercepts are averaged and this value is used to determine G from Table 4 or the equation in Table 6. The individual intercepts may be plotted in a histogram, but this is beyond the scope of these test methods.

18. Report

18.1 The test report should document all of the pertinent identifying information regarding the specimen, its composition, specification designation or trade name, customer or data requester, date of test, heat treatment or processing history, specimen location and orientation, etchant and etch method, grain size analysis method, and so forth, as required.

18.2 List the number of fields measured, the magnification, and field area. The number of grains counted or the number of intercepts or intersections counted, may also be recorded. For a two-phase structure, list the area fraction of the matrix phase.

18.3 A photomicrograph illustrating the typical appearance of the grain structure may be provided, if required or desired.

18.4 List the mean measurement value, its standard deviation, 95 % confidence interval, percent relative accuracy, and the ASTM grain size number.

18.4.1 For the comparison method, list only the estimated ASTM grain size number.

18.5 For a non-equiaxed grain structure, list the method of analysis, planes examined, directions evaluated (if applicable), the grain size estimate per plane or direction, the grand mean of the planar measurements, and the computed or estimated ASTM grain size number.

18.6 For a two-phase structure, list the method of analysis, the amount of the matrix phase (if determined), the grain size measurement of the matrix phase (and the standard deviation, 95 % confidence interval, and percent relative accuracy), and the computed or estimated ASTM grain size number.

18.7 If it is desired to express the average grain size of a group of specimens from a lot, do not simply average the ASTM grain size numbers. Instead, compute an arithmetic average of the actual measurements, such as, the \bar{N}_A or ℓ values per specimen. Then, from the lot average, calculate or estimate the ASTM grain size for the lot. The specimen values of \bar{N}_A or ℓ may also be statistically analyzed, according to the approach in Section 15, to evaluate the grain size variability within the lot.

19. Precision and Bias

19.1 The precision and bias of grain size measurements depend on the representativeness of the specimens selected and the areas on the plane-of-polish chosen for measurement. If the grain size varies within a product, specimen and field selection must adequately sample this variation.

19.2 The relative accuracy of the grain size measurement of the product improves as the number of specimens taken from the product increases. The relative accuracy of the grain size measurement of each specimen improves as the number of fields sampled and the number of grains or intercepts counted increase.

19.3 Bias in measurements will occur if specimen preparation is inadequate. The true structure must be revealed and the

grain boundaries must be fully delineated for best measurement precision and freedom from bias. As the percentage of non-delineated grain boundaries increases, bias increases and precision, repeatability, and reproducibility become poorer.

19.4 Inaccurate determination of the magnification of the grain structure will produce bias.

19.5 If the grain structure is not equiaxed in shape, for example, if the grain shape is elongated or flattened by deformation, measurement of the grain size on only one plane, particularly the plane perpendicular to the deformation direction, will bias test results. Grain shape distortion is best detected using a test plane parallel to the deformation direction. The size of the deformed grains should be based on measurements made on two or three of the principal planes which are averaged as described in Section 16.

19.6 Specimens with a unimodal grain size distribution are measured for average grain size using the methods described in these test methods. Specimens with bimodal (or more complex) size distributions should not be tested using a method that yields a single average grain size value; they should be characterized using the methods described in Test Methods E 1181 and measured using the methods described in Test Methods E 112. The size of individual very large grains in a fine grained matrix should be determined using Test Methods E 930.

19.7 When using the comparison chart method, the chart selected should be consistent with the nature of the grains (that is, twinned or non-twinned, or carburized and slow cooled) and the etch (that is, flat etch or grain contrast etch) for best precision.

19.8 Grain size ratings using the comparison chart method by an individual metallographer will vary within $\pm 0.5 G$ units. When a number of individuals rate the same specimen, the spread in ratings may be as great as 1.5 to 2.5 G units.

19.9 The fracture grain size method is only applicable to hardened, relatively brittle, tool steels. Specimens should be in the as-quenched or lightly tempered condition so that the fracture surface is quite flat. An experienced metallographer can rate the prior-austenite grain size of a tool steel within $\pm 0.5 G$ units by the Shepherd fracture grain size method.

19.10 A round robin test program (see Appendix X1), analyzed according to Practice E 691, revealed a rather consistent bias between comparison chart ratings using Plate I and grain size measurements using both the planimetric and intercept methods. Chart ratings were 0.5 to 1 G unit coarser, that is, lower G numbers, than the measured values.

19.11 Grain sizes determined by either the planimetric or intercept methods produced similar results with no observed bias.

19.12 The relative accuracy of grain size measurements improved as the number of grains or intercepts counted increased. For a similar number of counts, the relative accuracy of intercept measurements was better than that of planimetric measurements of grain size. For the intercept method, 10 % RA (or less) was obtained with about 400 intercept or intersection counts while for the planimetric method, to obtain 10 % RA, or less, about 700 grains had to be counted. Repeatability and reproducibility of measurements improved as the number of grains or intercepts counted increased and was better for the intercept method than for the planimetric method for the same count.

19.13 The planimetric method requires a marking off of the grains during counting in order to obtain an accurate count. The intercept method does not require marking in order to get an accurate count. Hence, the intercept method is easier to use and faster. Further, the round robin test showed that the intercept method provides better statistical precision for the same number of counts and is, therefore, the preferred measurement method.

19.14 An individual metallographer can usually repeat planimetric or intercept grain size measurements within $\pm 0.1 G$ units. When a number of metallographers measure the same specimen, the spread of grain sizes is usually well within $\pm 0.5 G$ units.

20. Keywords

20.1 ALA grain size; anisotropy index; area fraction; ASTM grain size number; calibration; equiaxed grains; etchant; grain boundary; grains; grain size; intercept count; intercept length; intersection count; non-equiaxed grains; twin boundaries

ANNEXES

(Mandatory Information)

A1. BASIS OF ASTM GRAIN SIZE NUMBERS

A1.1 Descriptions of Terms and Symbols

A1.1.1 The general term *grain size* is commonly used to designate size estimates or measurements made in several ways, employing various units of length, area, or volume. Of the various systems, only the ASTM grain size number, G , is essentially independent of the estimating system and measurement units used. The equations used to determine G from recommended measurements, as illustrated in Fig. 6 and Table 2 and Table 4, are given in A1.2 and A1.3. The nominal

relationships between commonly used measurements are given in Annex A2. Measurements that appear in these equations, or in equations in the text, are as follows:

A1.1.1.1 N = Number of grain sections counted on a known test area, A , or number of intercepts counted on a known test array of length = L , at some stated magnification, M . The average of counts on several fields is designated as \bar{N} .

A1.1.1.2 After correction for magnification, N_A is the number of grain sections per unit test area (mm^{-2}); N_L is the

number of grains intercepted per unit length (mm) of test lines at 1X; and P_L is the number of grain boundary intersections per unit length (mm) of test line at 1X.

A1.1.1.3 $\bar{\ell} = 1/N_L = 1/P_L$ where $\bar{\ell}$ is the mean lineal intercept length in mm at 1X.

A1.1.1.4 $\bar{A} = 1/N_A$ where \bar{A} is the mean area of the grain sections (mm^2) at 1X. The mean grain diameter, \bar{d} , is the square root of \bar{A} . Grain size values on Plate III are expressed in terms of \bar{d} . Note that Table 2 lists the equivalent ASTM grain size number for each chart picture and for several different magnifications.

A1.1.1.5 The letters ℓ , t and p are used as subscripts when assessing the grain size of specimens with non-equiaxed grain structures. The three subscripts represent the principal planes for rectangular bar, plate, sheet, or strip specimens, that is, the longitudinal (ℓ), transverse (t) and planar (p) surfaces. They are mutually perpendicular to each other. On each plane, there are two principal directions that are perpendicular to each other (as illustrated in Fig. 7).

A1.1.1.6 The number of fields measured is designated by n .

A1.1.1.7 Other specific designations are defined by equations which follow.

A1.2 Intercept Methods:

A1.2.1 Metric units, $\bar{\ell}$ in millimetres at 100X for microscopically determined grain sizes and $\bar{\ell}_m$ at 1X for macroscopically determined grain sizes, are used with the following equation relating $\bar{\ell}$ or $\bar{\ell}_m$ to G . For macroscopically determined grain sizes, $\bar{\ell}_m$ is in mm at 100X:

$$G = 2 \log_2 \frac{\ell_0}{\bar{\ell}_m} \quad (\text{A1.1})$$

for $G = 0$, ℓ_0 is established as 32.00 and $\log_2 \ell_0 = 5$.

$$G = +10.000 - 2 \log_2 \bar{\ell}_m \quad (\text{A1.2})$$

$$G = +10.0000 - 6.6439 \log_{10} \bar{\ell}_m \quad (\text{A1.3})$$

For microscopically determined grain sizes, $\bar{\ell}$ is in millimetres at 1X and:

$$G = -3.2877 - 6.6439 \log_{10} \bar{\ell} \quad (\text{A1.4})$$

$$G = -3.2877 + 2 \log_2 \bar{N}_L \quad (\text{A1.5})$$

$$G = -3.2877 + 6.6439 \log_{10} \bar{N}_L \quad (\text{A1.6})$$

If \bar{P}_L is determined instead of \bar{N}_L , substitute \bar{P}_L for \bar{N}_L in Eq A1.5 and Eq A1.6.

A1.3 Planimetric Method:

A1.3.1 English units, \bar{N}_{AE} in number per square inches at 100X for microscopically determined grain sizes and at 1X for macroscopically determined grain sizes, are used with the following equations relating \bar{N}_{AE} to G :

$$G = 1.000 + \log_2 \bar{N}_{AE} \quad (\text{A1.7})$$

$$G = 1.000 + 3.3219 \log_{10} \bar{N}_{AE} \quad (\text{A1.8})$$

If \bar{N}_A is expressed in terms of the number of grains per square millimetres at 1X, for microscopically determined grain sizes, then:

$$G = 2.9542 + 3.3219 \log_{10} \bar{N}_A \quad (\text{A1.9})$$

A2. EQUATIONS FOR CONVERSIONS AMONG VARIOUS GRAIN SIZE MEASUREMENTS

A2.1 *Change of Magnification*—If the apparent grain size has been observed at magnification M , but determined as if at the basic magnification M_b (100X or 1X), then the size value at the basic magnification is as follows:

A2.1.1 Planimetric Count:

$$N_A = N_{A0} (M/M_b)^2 \quad (\text{A2.1})$$

where N_{A0} is the number of grains per unit area at magnification M_b .

A2.1.2 Intercept Count:

$$N_i = N_{i0} (M/M_b) \quad (\text{A2.2})$$

where N_{i0} is the number of grains intercepted by the test line (the equation for P_i and P_{i0} is the same) at magnification M_b .

A2.1.3 Any Length:

$$\ell = \ell_0 M_b / M \quad (\text{A2.3})$$

where ℓ_0 is the mean lineal intercept at magnification M_b .

A2.1.4 ASTM Grain Size Number:

$$G = G_0 + Q \quad (\text{A2.4})$$

where:

$$\begin{aligned} Q &= 2 \log_2 (M/M_b) \\ &= 2 (\log_2 M - \log_2 M_b) \end{aligned}$$

$$= 6.6439 (\log_{10} M - \log_{10} M_b)$$

where G_0 is the apparent ASTM grain size number at magnification M_b .

A2.1.5 Grains per mm^2 at 1X from grains per in^2 at 100X:

$$N_A = N_{AE} (100/25.4)^2 \quad (\text{A2.5})$$

$$N_A = 15.5 N_{AE} \quad (\text{A2.6})$$

where N_A is the number of grains per mm^2 at 1X and N_{AE} is the number of grains per in^2 at 100X.

A2.2 Other measurements shown in the tables may be computed from the following equations:

A2.2.1 Area of Average Grain:

$$\bar{A} = 1/N_A \quad (\text{A2.7})$$

where \bar{A} is the average grain cross sectional area.

A2.2.2 Intercept Width of a Circular Grain Section:

$$\bar{\ell} = \left(\frac{\pi}{4} \bar{A} \right)^{1/2} \quad (\text{A2.8})$$

The mean intercept distance for polygonal grains varies about this theoretical value, being decreased by anisotropy but increased by a range of section sizes. The width computed by

(Eq A2.8) is 0.52 % smaller than the width assigned to G by (Eq A1.4) in A1.2.1 ($\Delta = +0.015$ ASTM No.).

A2.3 Other useful size indications are given by the following equations:

A2.3.1 The volumetric (spatial) diameter, \bar{D} , of similar size spheres in space is:

$$\bar{D} = 1.5\bar{\ell} \quad (\text{A2.9})$$

Similar relationships between $\bar{\ell}$, determined on the two-dimensional plane of polish, and the spatial diameter, \bar{D} , have been derived for a variety of potential grain shapes, and various assumptions about their size distribution. A number of formu-

lae, such as equation (Eq A2.7), have been proposed with different multiplying factors. A reasonable estimate of the spatial diameter, \bar{D} , based upon the tetrakaidecahedron shape model and a grain size distribution function (8), is:

$$\bar{D} = 1.571 \ell \quad (\text{A2.10})$$

A2.3.2 For a single phase microstructure, the grain boundary surface area per unit volume, S_V , has been shown to be an exact function of P_L or N_L :

$$S_V = 2P_L = 2N_L \quad (\text{A2.11})$$

while for a two phase microstructure, the phase boundary surface area per unit volume of the α phase, $S_{V\alpha}$, is:

$$S_{V\alpha} = 2P_L = 4N_L \quad (\text{A2.12})$$

A3. AUSTENITE GRAIN SIZE, FERRITIC AND AUSTENITIC STEELS

A3.1 Scope

A3.1.1 Because it is sometimes necessary to subject material to special treatments or techniques in order to develop certain grain characteristics prior to the estimation of grain size, the essential details of these treatments are set forth in the following sections.

A3.2 Establishing Austenite Grain Size

A3.2.1 *Ferritic Steels*— Unless otherwise specified, austenite grain size shall be established by one of the following procedures:

NOTE A3.1—The indications of carbon contents in the procedure headings are advisory only. Numerous methods are in use for establishing austenite grain size, and a knowledge of grain growth and grain coarsening behavior is helpful in deciding which method to use. The size of austenite grains, in any particular steel, depends primarily on the temperature to which that steel is heated and the time it is held at the temperature. It should be remembered that the atmosphere in heating may affect the grain growth at the outside of the piece. Austenite grain size is also influenced by most previous treatments to which the steel may have been subjected as, for example, austenitizing temperature, quenching, normalizing, hot working, and cold working. It is therefore advisable, when testing for austenite grain size, to consider the effects of prior or subsequent treatments, or both, on the precise piece (or typical piece) that is under consideration.

A3.2.1.1 *Correlation Procedure (Carbon and Alloy Steels)*—Test conditions should correlate with the actual heat-treatment cycle used to develop the properties for actual service. Heat the specimens at a temperature not over 50°F (28°C) above the normal heat-treating temperature and for not over 50 % more than the normal heat-treating time and under normal heat-treating atmosphere, the normal values being those mutually agreed upon. The rate of cooling depends on the method of treatment. Make the microscopical examination in compliance with Table 1.

A3.2.1.2 *Carburizing Procedure (Carbon and Alloy Steels; Carbon Generally Below 0.25 %)*—This procedure is usually referred to as the McQuaid—Ehn Test. Unless otherwise specified, carburize the specimens at 1700 ± 25°F (927 ± 14°C) for 8 h or until a case of approximately 0.050 in. (1.27 mm) is obtained. The carburizing compound must be capable of producing a hypereutectoid case in the time and at the

temperature specified. Furnace cool the specimen to a temperature below the lower critical at a rate slow enough to precipitate cementite in the austenite grain boundaries of the hypereutectoid zone of the case. When cool, section the specimen to provide a fresh-cut surface, polish, and suitably etch to reveal the grain size of the hypereutectoid zone of the case. Make a microscopical examination in compliance with Table 1. While the McQuaid-Ehn test was designed for evaluating the grain growth characteristics of steels intended for carburizing applications, usually steels with <0.25 % carbon, it is frequently used to evaluate steels with higher carbon contents that will not be carburized. It must be recognized that the grain size of such steels when heat treated from austenitizing temperatures below 1700°F may be finer in size than that obtained by the McQuaid-Ehn test.

A3.2.1.3 *Mock Carburizing Procedure*—The heat treatment described in A3.2.1.2 is performed but a carburizing atmosphere is not used and the specimen must be quenched from the mock carburizing temperature at a rate fast enough to form martensite, rather than slowly cooled after carburizing. The specimen is sectioned (careful abrasive cut-off cutting is required to prevent burning), polished and etched with a reagent that will reveal the prior-austenite grain boundaries (such as saturated aqueous picric acid with a wetting agent, see Practice E 407). Mock carburizing is sometimes preferred because the depth of the carburized case produced by the McQuaid-Ehn test may be quite thin with some steels. With a mock carburized specimen, all of the grains on the cross section can be examined. Problems such as banded grain size, duplex or ALA grains (see Test Methods E 1181) are more easily detected with a mock carburized specimen due to the much greater surface area for examination.

A3.2.1.4 *Hypoeutectoid Steels (Carbon and Alloy Steels 0.25 to 0.60 % Carbon)*—Unless otherwise specified, heat specimens of steels with a carbon content of 0.35 % or less at 1625 ± 25°F (885 ± 14°C); heat specimens of steel with a carbon content of over 0.35 % at 1575 ± 25°F (857 ± 14°C) for a minimum of 30 min and cool in air or quench in water. The higher carbon steels in this range and alloy steels over approximately 0.40 % carbon may require an adjustment in

cooling practice to outline clearly the austenite grain boundaries with ferrite. In such cases it is recommended that after holding the specimen for the required time at a hardening temperature, the temperature be reduced to approximately 1340 ± 25°F (727 ± 14°C) for 10 min, followed by water or oil quench. When cool, section the specimen to provide a fresh-cut surface, polish, and suitably etch to reveal the austenite grain size as outlined by precipitated ferrite in the grain boundaries. Make the microscopical examination in compliance with Table 1.

A3.2.1.5 Oxidation Procedure (Carbon and Alloy Steels 0.25 to 0.60 % Carbon)—Polish one of the surfaces of the specimen (approximately 400-grit or 15- μ m abrasive). Place the specimen with the polished side up in a furnace, and, unless otherwise specified, heat at 1575 ± 25°F (857 ± 14°C) for 1 h and quench in cold water or brine. Polish the quenched specimen to reveal the austenite grain size as developed in the oxidized surface. Make the microscopical examination in compliance with Table 1.

A3.2.1.6 Direct Hardening Steels (Carbon and Alloy Steels; Carbon Generally Below 1.00 %)—Unless otherwise specified, heat specimens of steels with a carbon content of 0.35 % or less at 1625 ± 25°F (885 ± 14°C); heat specimens of steels with a carbon content of over 0.35 % at 1575 ± 25°F (857 ± 14°C) for sufficient time and quench at a rate to produce full hardening. Polish the quenched specimen and etch to reveal the martensitic structure. Tempering for 15 min at 450 ± 25°F (232 ± 14°C) prior to etching improves the contrast. Make the microscopical examination in compliance with Table 1.

A3.2.1.7 Hypereutectoid Steels (Carbon and Alloy Steels; Carbon Generally Over 1.00 %)—Use a specimen approximately 1 in. (25.4 mm) in diameter or 1 in. square for this test. Unless otherwise specified, heat the specimen at 1500 ± 25°F (816 ± 14°C) for a minimum of 30 min, and furnace cool to a temperature below the lower critical temperature at a rate slow enough to precipitate cementite in the austenite grain boundaries. When cool, section the specimen to provide a fresh-cut surface, polish, and suitably etch to reveal the austenite grain size as outlined by precipitated cementite in the grain boundaries. Make the microscopical examination in compliance with Table 1.

A3.2.2 Austenitic Steels—With austenitic materials, the actual grain size of the metal has been established by prior heat-treatment.

A3.3 Revealing the Grain Size

A3.3.1 Ferritic Steels—For revealing austenite grain size the following methods (see Note A3.1) are generally used:

A3.3.1.1 Outlining the Grains with Cementite—In the hypereutectoid zone of a carburizing (McQuaid—Ehn test) procedure or in hypereutectoid steels cooled from the austenitic condition, the austenite grain size is outlined by the cementite which precipitated in the grain boundaries. It is therefore possible to rate the grain size by etching the micrographic specimen with a suitable etchant,¹⁰ such as nital, picral, or alkaline sodium picrate.

A3.3.1.2 Outlining the Grains with Ferrite—In the hypoeutectoid zone of a carburized specimen, the austenite grain size is outlined by the ferrite that precipitated in the grain boundaries. Ferrite similarly outlines the former austenite grains in a medium-carbon steel (approximately 0.50 % carbon), when it has been cooled slowly from the austenite range. In low-carbon steels (approximately 0.20 % carbon), cooling slowly from the austenite range to room temperature, the amount of ferrite is so large that the former austenite grain size is masked; in this case, the steel may be cooled slowly to an intermediate temperature, to allow only a small amount of ferrite to precipitate, followed by quenching in water; an example would be a piece previously heated to 1675°F (913°C), transferred to a furnace at between 1350 to 1450°F (732 to 788°C), held at this temperature for perhaps 3 to 5 min, and then quenched in water; the austenite grain size would be revealed by small ferrite grains outlining low-carbon martensite grains.

A3.3.1.3 Outlining the Grains by Oxidation—The oxidation method depends on the fact that when steels are heated in an oxidizing atmosphere, oxidation takes place in part preferentially along the grain boundaries. A common procedure, therefore, is to polish the test specimen to a metallographic polish, heat it in air at the desired temperature for the desired length of time, and then repolish the specimen lightly so as merely to remove scale; whereupon the austenite grain boundaries are visible as outlined by oxide.

A3.3.1.4 Outlining Martensite Grains with Fine Pearlite—A method applicable particularly to eutectoid steels, which cannot be judged so readily by some other methods, is either to harden a bar of such a size that it is fully hardened at the outside but not quite fully hardened in the interior, or to employ a *gradient quench* in which the heated piece is for a portion of its length immersed in water and therefore fully hardened, the remainder of the piece projecting above the quenching bath, being therefore not hardened. With either method there will be a small zone which is almost but not quite fully hardened. In this zone, the former austenite grains will consist of martensite grains surrounded by small amounts of fine pearlite, thus revealing the grain size. These methods are also applicable to steels somewhat lower and higher than the eutectoid composition.

A3.3.1.5 Etching of Martensite Grains—The former austenite grain size may be revealed in steels fully hardened to martensite by using an etching reagent that develops contrast between the martensite grains. Tempering for 15 min at 450°F (232°C) prior to etching distinctly improves the contrast. A reagent that has been recommended is 1 g of picric acid, 5 mL of HCl (sp gr 1.19), and 95 mL of ethyl alcohol. An alternate approach is to use an etchant that reveals the prior-austenite grain boundaries preferentially. Many etchants have been developed for this purpose (see Practice E 407 and standard text books). The most successful consists of saturated aqueous picric acid containing a wetting agent, usually sodium tridecylbenzene sulfonate (the dodecyl version also works well). Specimens should be in the as-quenched condition or tempered not above about 1000°F. Success with this etchant depends upon the presence of phosphorus in the alloy (≥ 0.005 % P required). Results may be enhanced by tempering the steel

¹⁰ See Practice E 407.

between 850 and 900°F for 8 h or more to drive phosphorus to the grain boundaries. For steels with substantial alloy additions, it may be necessary to add a few drops of hydrochloric acid to the etchant (per 100 mL of etchant). Etching usually takes at least 5 min. The etchant will attack sulfide inclusions. Lightly re-polishing the specimen on a stationary wheel to remove some of the unimportant background detail may make it easier to see the grain boundaries.

A3.3.2 Austenitic Steels—For revealing the grain size in austenitic materials, a suitable etching technique shall be used to develop grain size. Recognizing that twinning tends to confuse reading of grain size, the etching should be such that a minimum amount of twinning is evident.

A3.3.2.1 Stabilized Material—The specimen, as the anode, may be electrolytically etched in a water solution composed of 60 % concentrated nitric acid by volume, at ambient temperature. To minimize the appearance of twinning, a low voltage (1 to 1½ V) should be used. This etchant is also recommended for revealing ferrite grain boundaries in ferritic stainless steels and is used identically.

A3.3.2.2 Unstabilized Material—The grain boundary may be developed through precipitation of carbides by heating

within the sensitizing temperature range, 482 to 704°C (900 to 1300°F). Any suitable carbide-revealing etchant should be used.

A3.4 Reporting the Grain Size

A3.4.1 Ferritic Steels—Duplex, or mixed grain-sized structure (see Test Methods E 1181) when observed, shall be reported with two representative ranges of grain size numbers. Whenever heat-treatments other than the carburizing (McQuaid—Ehn test) procedure are employed to develop austenite grain size, a complete report shall be made which includes:

A3.4.1.1 Temperature used in establishing the grain size,

A3.4.1.2 Time at temperature used in establishing the grain size,

A3.4.1.3 Method of revealing grain size, and

A3.4.1.4 Grain size.

A3.4.2 Austenitic Steels—In determining the size of austenitic grains, the twin boundaries within a grain shall not be counted.

A4. FRACTURE GRAIN SIZE METHOD¹¹

A4.1 The fracture grain size method, developed by Arpi (9), and Shepherd (2), employs a graded series of ten fractured specimens to estimate the prior-austenite grain size of steel specimens (see Footnote 11 for applicable materials) by comparison. Carburized cases of carbon and alloy steels may also be evaluated for prior-austenite grain size by this method (but not the low-carbon core).

A4.2 The ten fractured specimens are numbered from one to ten where the numbers correspond to ASTM grain size numbers. The sample to be rated is fractured, usually transverse to the hot working direction, and the fracture is compared to the ten test fractures of the Shepherd series.¹² The fracture appearance of the specimen is rated to the nearest whole number of the standard, but interpolation to one-half numbers is permitted. It is also possible to rate duplex conditions when the fracture exhibits two different fracture patterns.

A4.3 Specimens can be fractured by striking the free end, while restraining the other end, or by three-point bending using a press, or a tensile machine (loaded in compression) or any other suitable method. Notching of specimens or refrigeration

prior to fracturing, or both, helps to ensure a flat fracture. For further information see Vander Voort (10).

A4.4 The specimen to be rated must be predominantly martensitic, although large amounts of retained austenite do not invalidate the results. Appreciable amounts of residual carbide are also permitted. However, diffusion controlled transformation products, such as bainite, pearlite, or ferrite, if present in amounts more than a few percent, change the nature of the fracture appearance and invalidate fracture grain size ratings. Excessive tempering of martensitic tool steel structures also alters the fracture appearance and invalidates fracture grain size ratings. Ratings are most accurate for as-quenched or lightly tempered specimens. Flat, brittle fractures are desired to obtain the best accuracy.

A4.5 Studies have shown that fracture grain size ratings of fully hardened, as-quenched tool steels correlate well with microscopically measured prior-austenite grain size ratings. For most tool steels, the fracture grain size rating will be within ±1 unit of the microscopically determined prior-austenite grain size number, *G*.

A4.6 The fracture grain size method cannot be used to rate grain sizes finer than ten. Fractures of specimens with prior-austenite grain sizes finer than ten cannot be discriminated by eye and will be rated as if they were a ten grain size. Fractures coarser than a grain size number of one will appear to be coarser than one but cannot be accurately rated by this method.

¹¹ This method is applicable only to high-hardness, brittle steels with a predominantly martensite microstructure, such as tool steels, high-carbon steels and martensitic stainless steels, and should be done with the specimen in the as-quenched or lightly tempered condition.

¹² For those individuals who do not possess a Shepherd standard series, a photographic reproduction is available from ASTM Headquarters. Order PCN 12-501124-23.

A5. REQUIREMENTS FOR WROUGHT COPPER AND COPPER-BASE ALLOYS

A5.1 For wrought copper and copper-base alloy products under the jurisdiction of Committee B-5 on Copper and Copper Alloys, it is mandatory that the following procedures be followed:

A5.1.1 The specimen shall be prepared in accordance with Practice E 3.

A5.1.2 The specimen used for the comparison method shall be contrast etched, and compared with Plate III, or, if given a flat etch, compared with Plate II.

A5.1.3 The grain size shall be expressed as the average grain diameter in millimetres; for example, 0.025-mm average grain diameter. The meaning of this expression is the diameter of the average cross section of grains lying in the plane of the metal being examined.

A5.1.4 Mixed grain sizes (see Test Methods E 1181) are sometimes encountered, particularly in hot-worked metal. These shall be expressed by giving the estimated area percentages occupied by the two ranges of sizes. For example, 50 % of 0.015 mm; and 50 % of 0.070 mm; or, if a range exists, 40 % of 0.010 to 0.020 mm; and 60 % of 0.090 to 0.120 mm.

A5.1.5 For determining compliance of requirements for grain size with the specified limits, the estimated value shall be rounded in accordance with:

Grain Size	Calculated or Observed Value to Which Grain Size Should be Rounded
Up to 0.055 mm, incl	to the nearest multiple of 0.005 mm
Over 0.055 mm	to the nearest 0.010 mm

A6. APPLICATION TO SPECIAL SITUATIONS

A6.1 Numerous specific practices for grain size measurement have become established in various segments of the metals and materials industries. The present listing of standard methods is not intended to imply that any such specific practice should be abandoned when experience has shown that practice to be adequate for the intended application. It is, however, strongly recommended that the statistical procedure of Section 15 be applied to the data from these traditional practices in order to ensure that they yield a confidence limit that is adequate for current requirements.

A6.2 It is characteristic of many special practices that they report a numerical result that is not conveniently related to commonly used size scales such as are shown in Table 4. Continued usage of the customary numbers is justified on the grounds that either they have inherent meaning in their own community, or that they have acquired meaning through long usage. It is, however, strongly recommended that such measurements be made comprehensible to a wider audience first by reexpression on one of the preferred metric scales (as used in Table 4), and then by conversion to the corresponding ASTM grain size numbers. Where the original measurements represent some form of intercept or planimetric count it may be said that the ASTM grain size number has in fact been determined. Where the original data are of a different nature, it should be stated that the measurement is equivalent to ASTM grain size

No. “x”. Conversions may be made either through Table 4 or through the relations shown in Annex A1 and Annex A2.

A6.3 Examples:

A6.3.1 *Example 1*—The Snyder and Graff procedure (11) remains in general usage for estimating the austenitic grain size of tool steels. This is a specific version of the Heyn intercept method (see 13.1) in which the reported number is the average number of intercepts with a 5-in. (127-mm) test line applied to an image at 1000X. This count is more immediately useful than the ASTM grain size number itself, as important changes of quality are associated with a change of about two ASTM size numbers, which difference is not well resolved on the logarithmic size scale or by comparison or planimetric methods. The Snyder and Graff size number will become meaningful to others by multiplying by the factor 7.874 to yield N_L per millimetre, after which Table 4 will indicate, for example, that S&G No. 15 is ASTM grain size No. 10.5. Furthermore, as the precision of this practice does not attain 2 % of the count, the 5-in. (127-mm) test line could be replaced by a 125-mm test line without invalidating past records, making the multiplier 8.0, whereupon the total intercept count on eight test lines equals N_L directly. The confidence limit evaluation in Section 15 can be applied to single test lines, or to totals on fixed numbers of lines in each local area.

APPENDIXES

(Nonmandatory Information)

X1. RESULTS OF INTERLABORATORY GRAIN SIZE DETERMINATIONS¹³

X1.1 This interlaboratory test program was conducted to develop precision and bias estimates for the measurement of grain size by the chart comparison method, by the planimetric method, and by the intercept method.

X1.2 Procedure

X1.2.1 Photomicrographs (8 by 10 in.) of two different ferritic stainless steels, four of one specimen at different magnifications and three of the other specimen at different magnifications, were rated for grain size using the chart method with Plate I and by the planimetric and intercept methods. A drawing of the grain boundaries of a specimen of austenitic Hadfield’s manganese steel, with a grain contrast etch, was also evaluated by all three methods. A number of other micrographs were rated only by the comparison method. In each case, the grain boundaries were clearly and fully delineated.

X1.2.2 For the planimetric method, each rater was given an 8 by 10 in. clear plastic template with five 79.8 mm diameter test circles and a grease pencil. For the intercept method, each rater was given a single three-circle template.

X1.2.3 For the planimetric method, the template was dropped onto the photograph and taped down to prevent movement. Because the circles grid and the micrograph were nearly the same size, grid placement should be rather consistent between raters. For the intercept method, the raters dropped their grid onto the micrograph five times at random. It

was assumed that this difference in placement method would reduce the variability of the planimetric method relative to the intercept method.

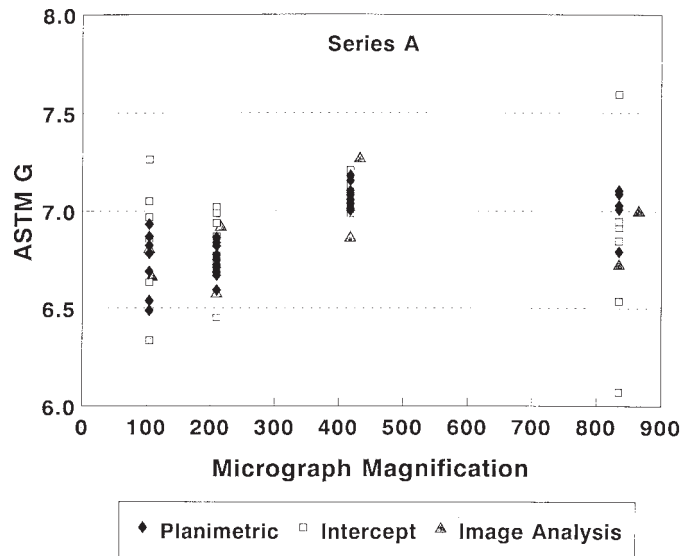

FIG. X1.1 Grain Size Measurements for the Series A Ferritic Stainless Steel Specimens

X1.3 Results

X1.3.1 Figs. X1.1 and X1.2 show the grain size ratings for the two ferritic stainless steels, identified as Series A and B, as a function of the magnification of the micrographs, for the planimetric and intercept methods. Three people also made

¹³ Supporting data have been filed at ASTM Headquarters and may be obtained by requesting RR:E 04-1005.

TABLE X1.1 Results of ASTM Grain Size Round Robin (Planimetric Method)

Image	No./sq. mm	ASTM G	Average No.	Repeatability 95 % CL	Reproducibility 95 % CL	Repeatability % RA	Reproducibility % RA
A1	846.64	6.77	1918.0	106.11	266.56	12.53	31.49
A2	831.61	6.75	474.5	209.68	239.88	25.21	28.85
A3	1046.98	7.08	150.5	499.42	489.10	47.70	46.72
A4	978.49	6.98	35.5	785.07	765.18	80.23	78.20
B1	1054.12	7.09	608.5	342.21	344.35	32.46	32.67
B2	1069.41	7.11	152.5	464.60	452.27	43.44	42.29
B3	1184.01	7.26	41.5	435.21	403.98	36.76	34.12

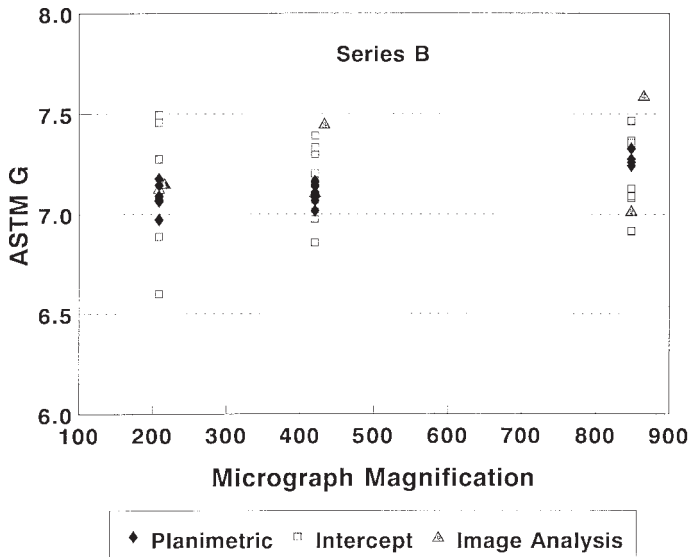
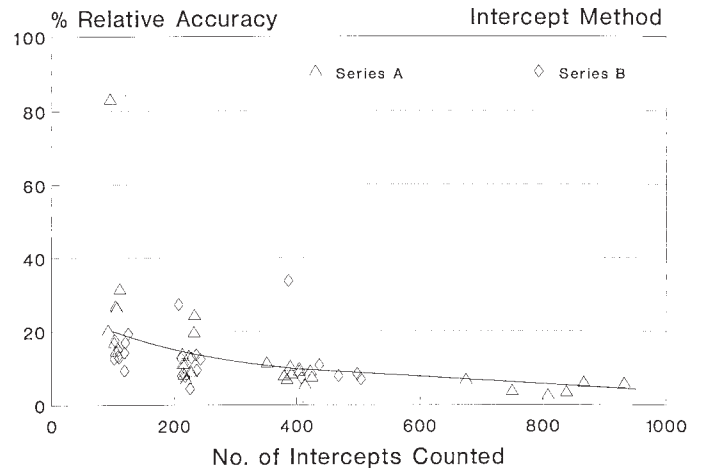
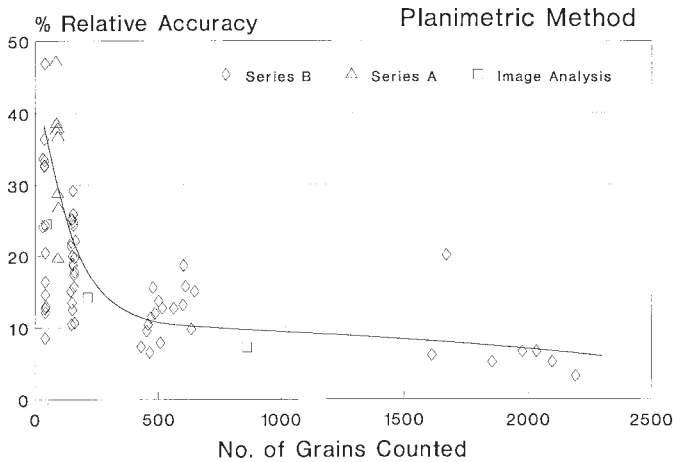

FIG. X1.2 Grain Size Measurements for the Series B Ferritic Stainless Steel Specimens



NOTE 1—The image analysis results for the same micrographs.
FIG. X1.4 Relationship Between the Number of Intercepts or Intersections Counted and the Percent Relative Accuracy for the Intercept Method



NOTE 1—The image analysis results for the same micrographs.
FIG. X1.3 Relationship Between the Number of Grains Counted and the Percent Relative Accuracy for the Planimetric Method

image analysis measurements of the images. As can be seen, the tightest spread occurred, for both sets of micrographs, at a magnification of about 400X where the average grain count per planimetric measurement was about 30 to 35 and the average number of intercepts or intersections was about 40 to 50 per three-circle application.

X1.3.2 Figs. X1.3 and X1.4 show how the percent relative accuracy of the measurements varied with the number of grains counted, Fig. X1.3, and with the number of intercepts or intersections counted, Fig. X1.4. All of the measurement data are included. Note that a percent RA of 10 %, or less, is obtained when about 700 or more grains are counted by the planimetric method and when about 400 grain boundary intersections or grain intercepts are counted for the intercept method. Because the grains must be marked off on the template as they are counted to ensure counting accuracy in the planimetric method, while marking is not needed for the intercept method, it is clear that the intercept method is a more efficient method.

X1.3.3 Tables X1.1 and X1.2 list the results of the analysis of repeatability and reproducibility according to Practice E 691. In general, the intercept method outperformed the planimetric method in this study.

X1.3.4 Fig. X1.5 shows a plot of the planimetric versus the intercept grain size rating for each micrograph by each rater. Note that the data are scattered at random around the one-to-one trend line. This indicates that there was no bias in the grain size measurements by either method.

X1.3.5 Each micrograph that was rated for grain size could be considered in two ways, first as a rating for the true magnification of the micrograph and second for a rating as if the micrograph was at 100X. For evaluation of the comparison method, it was assumed that each micrograph was at 100X.

TABLE X1.2 Results of ASTM Grain Size Round Robin (Intercept Method)

Image	\bar{r} (μm)	ASTM G	Average Intercepts	Repeatability 95 % CL	Reproducibility 95 % CL	Repeatability % RA	Reproducibility % RA
A1	29.9	6.84	811.5	3.25	9.37	10.87	31.35
A2	29.8	6.85	396.0	5.65	6.33	18.96	21.24
A3	27.2	7.11	222.5	8.28	8.16	30.43	30.00
A4	29.0	6.93	102.0	14.90	16.46	51.37	56.77
B1	26.1	7.23	450.0	4.96	7.96	19.01	30.51
B2	26.7	7.17	223.5	6.19	7.01	23.20	26.26
B3	26.6	7.18	113.0	8.84	9.86	33.24	37.08

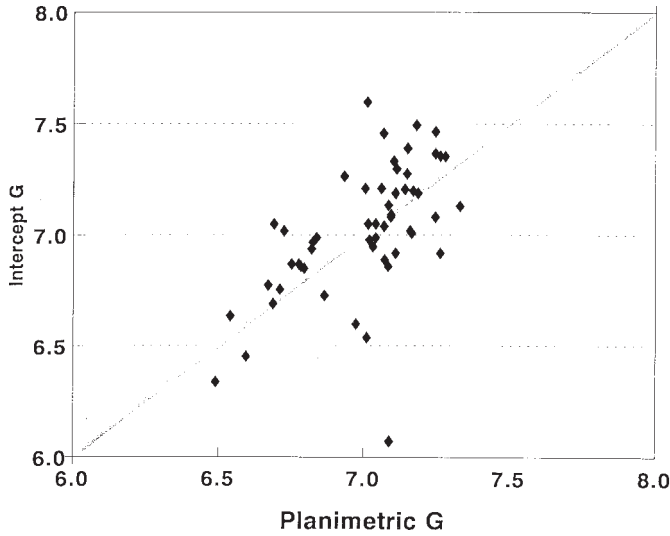
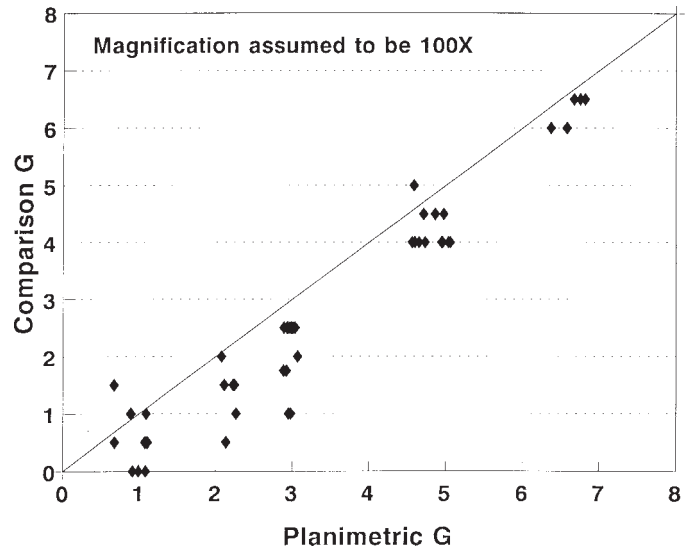

FIG. X1.5 Comparison of the Grain Size Measurements for Each Micrograph by Each Operator by the Planimetric and Intercept Methods



NOTE 1—Chart plots by each rater and assumes the micrographs are at 100X magnification. The data generally fall to one side of the one to one trend line indicating a bias.

FIG. X1.6 Plot of the Comparison Chart Grain Size Ratings for Each Micrograph Versus the Planimetric Method Rating for Each Micrograph

The intercept and planimetric data were also computed using this assumption. Figs. X1.6 and X1.7 show plots of the chart comparison ratings versus the planimetric and intercept ratings, assuming all micrographs were at 100X. Note that the data are not scattered at random around the one-to-one trend line. This clearly shows that bias is occurring in the chart comparison

ratings, which were typically 0.5 to 1 G unit lower, that is, coarser, than the planimetric or intercept measurements. The source of this bias is under study.

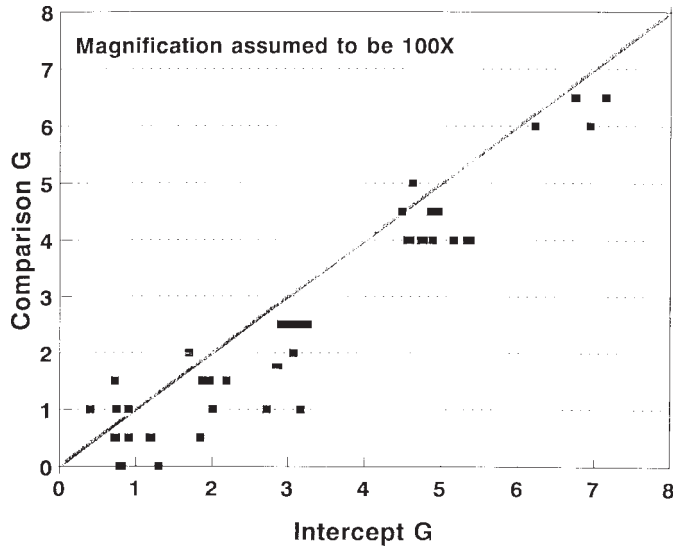

FIG. X1.7 Plot of the Comparison Chart Grain Size Ratings for Each Micrograph Versus the Intercept Method Rating for Each Micrograph

X2. REFERENCED ADJUNCTS

X2.1 The following is a complete and updated list of adjuncts referenced in Test Methods E 112. All adjuncts are available from ASTM.

Adjunct: Combination of 23 Components Combination of Plates I, II, III, and IV Plate I only Plate II only Plate III only Plate IV only Combination Transparencies, (Plate I) 00 through 10 Transparency, Grain Size 00 Transparency, Grain Size 0 Transparency, Grain Size 0.5	Order Adjunct: ADJE112CS ADJE112PS ADJE11201P ADJE11202P ADJE11203P ADJE11204P ADJE112TS ADJE11205T ADJE11206T ADJE11207T	Adjunct: Transparency, Grain Size 1.0 Transparency, Grain Size 1.5 Transparency, Grain Size 2.0 Transparency, Grain Size 2.5 Transparency, Grain Sizes 3.0, 3.5, and 4.0 Transparency, Grain Sizes 4.5, 5.0, and 5.5 Transparency, Grain Sizes 6.0, 6.5, and 7.0 Transparency, Grain Sizes 7.5, 8.0, and 8.5 Transparency, Grain Sizes 9.0, 9.5, and 10.0 Adjunct: Fig. 5 only Shepherd Series Reproduction	Order Adjunct: ADJE11208T ADJE11209T ADJE11210T ADJE11211T ADJE11212T ADJE11213T ADJE11214T ADJE11215T ADJE11216T Order ADJ: E11217F Order ADJ: ADJE011224
--	---	---	---

REFERENCES

- (1) Hull, F. C., *Transactions*, "A New Method for Making Rapid and Accurate Estimates of Grain Size," American Institute of Mining and Metallurgical Engineers, Vol 172, 1947, p. 439.
- (2) Shepherd, B. F., "The P-F Characteristic of Steel," *Transactions*, American Institute of Mining and Metallurgical Engineers, Vol 22, December 1934, pp. 979-1016.
- (3) Jeffries, Z., Kline, A. H., and Zimmer, E. B., "The Determination of the Average Grain Size in Metals," *Transactions*, American Institute of Mining and Metallurgical Engineers, Vol 54, 1917, pp. 594-607.
- (4) Heyn, E., "Short Reports from the Metallurgical Laboratory of the Royal Mechanical and Testing Institute of Charlottenburg," *Metallographist*, Vol 5, 1903, pp. 37-64.
- (5) Underwood, E. E., and Coons, W. C., "The Role of Quantitative Stereology in Deformation Twinning," *Deformation Twinning*, Gordon and Breach, New York, 1965, pp. 405-429.
- (6) Hilliard, J., "Estimating Grain Size by the Intercept Method," *Metal Progress*, Vol 85, May 1964.
- (7) Abrams, H., "Grain Size Measurement by the Intercept Method," *Metallography*, Vol 4, 1971, pp. 59-78.
- (8) Mendelson, M. I., "Average Grain Size in Polycrystalline Ceramics," *J. American Ceramic Society*, Vol 52, August 1969, pp. 443-446.
- (9) Arpi, R., "The Fracture Test as Used for Tool Steel in Sweden," *Metallography*, Vol 11, No. 65, March 1935, pp. 123-127.
- (10) Vander Voort, G. F., "Grain Size Measurement," *Practical Applications of Quantitative Metallography*, ASTM STP 839, 1984, pp. 85-181.
- (11) Snyder, R. W., and Graff, H. F., "Study of Grain Size in Hardened High Speed," *Metal Progress*, Vol 33, 1938, pp. 377-380.

ASTM International takes no position respecting the validity of any patent rights asserted in connection with any item mentioned in this standard. Users of this standard are expressly advised that determination of the validity of any such patent rights, and the risk of infringement of such rights, are entirely their own responsibility.

This standard is subject to revision at any time by the responsible technical committee and must be reviewed every five years and if not revised, either reapproved or withdrawn. Your comments are invited either for revision of this standard or for additional standards and should be addressed to ASTM International Headquarters. Your comments will receive careful consideration at a meeting of the responsible technical committee, which you may attend. If you feel that your comments have not received a fair hearing you should make your views known to the ASTM Committee on Standards, at the address shown below.

This standard is copyrighted by ASTM International, 100 Barr Harbor Drive, PO Box C700, West Conshohocken, PA 19428-2959, United States. Individual reprints (single or multiple copies) of this standard may be obtained by contacting ASTM at the above address or at 610-832-9585 (phone), 610-832-9555 (fax), or service@astm.org (e-mail); or through the ASTM website (www.astm.org).