



Standard Practices for Design, Testing, and Construction of Slurry Seal¹

This standard is issued under the fixed designation D 3910; the number immediately following the designation indicates the year of original adoption or, in the case of revision, the year of last revision. A number in parentheses indicates the year of last reapproval. A superscript epsilon (ϵ) indicates an editorial change since the last revision or reapproval.

This standard has been approved for use by agencies of the Department of Defense.

1. Scope

1.1 These practices cover the design, testing, and construction of mixtures for surface treatment of pavements. It is written as a guide and should be used as such. End-use specifications should be adapted to conform to job and user requirements.

1.2 *This standard does not purport to address all of the safety concerns, if any, associated with its use. It is the responsibility of the user of this standard to establish appropriate safety and health practices and determine the applicability of regulatory limitations prior to use.*

2. Referenced Documents

2.1 ASTM Standards:

C 128 Test Method for Specific Gravity and Absorption of Fine Aggregate²

D 242 Specification for Mineral Filler for Bituminous Paving Mixtures³

D 977 Specification for Emulsified Asphalt³

D 1073 Specification for Fine Aggregate for Bituminous Paving Mixtures³

D 2397 Specification for Cationic Emulsified Asphalt³

D 2419 Test Method for Sand Equivalent Value of Soils and Fine Aggregate³

E 145 Specification for Gravity-Convection and Forced-Ventilation Ovens⁴

2.2 Other Documents:⁵

ISSA Technical Bulletin No. 139 Test Method to Classify Emulsified Asphalt/Aggregate Mixture Systems by Modified Cohesion Tester Measurement of Set and Cure Characteristics.

3. Terminology

3.1 Definitions of Terms Specific to This Standard:

3.1.1 *emulsified asphalt slurry seal mixtures*— as related to

these practices, mixtures of fine aggregate with or without mineral filler, with or without mixing water, uniformly mixed with emulsified asphalt.

4. Significance and Use

4.1 These slurry seal practices are written as a guide and should not be construed as specifications.

4.2 End-use specifications should be adopted to conform to job and user requirements.

5. Design

5.1 Aggregates:

5.1.1 The fine aggregate shall consist of natural or manufactured sand, slag, crushed fines or other mineral aggregate that conforms to the quality requirements of Specification D 1073.

5.1.2 Recommended grading requirements are shown in Table 1.

5.1.3 Smooth-textured sand of less than 1.25 % water absorption shall not exceed 50 % of the total combined aggregate. (For heavy duty surface requirements, use 100 % crushed material.)

5.1.4 When tested by Test Method D 2419, the combined aggregate prior to the addition of any chemically active mineral fillers shall have a sand equivalent of not less than 45.

5.2 Mineral Filler:

5.2.1 Mineral fillers are of two types, chemically active and chemically inactive. Both shall conform to Specification D 242.

5.2.2 Chemically active mineral fillers such as portland cement, hydrated lime, and ammonium sulfate are used to improve the workability, regulate the setting time and, in some cases, to alter the aggregate gradation.

5.2.3 Chemically inactive mineral fillers such as limestone dust, flyash, and rock dust are used mainly to alter aggregate gradation.

5.3 *Emulsified Asphalt*—The emulsified asphalt shall conform to Grade SS-1h of Specification D 977, for emulsified asphalt, or Grade CSS-1h of Specification D 2397, for cationic emulsified asphalt.

5.3.1 Quick-Set emulsified asphalts, QS-1h and CQS-1h may also be used. They conform to Specifications D 977 and D 2397 respectively, except that the test requirements for cement mixing and storage stability shall not apply. Refer to

¹ These practices are under the jurisdiction of ASTM Committee D-4 on Road and Paving Materials and are the direct responsibility of Subcommittee D04.24 on Bituminous Macadam and Surface Treatments.

Current edition approved June 10, 1998. Published March 1999. Originally published as D 3910 – 80. Last previous edition D 3910 – 96.

² *Annual Book of ASTM Standards*, Vol 04.02.

³ *Annual Book of ASTM Standards*, Vol 04.03.

⁴ *Annual Book of ASTM Standards*, Vol 14.02.

⁵ Available from the International Slurry Surfacing Association, 1200 19th St. NW, Suite 300, Washington, DC. 20036-2401.

TABLE 1 Grading Requirements for Aggregate

Sieve Size	Amount Passing Sieve, weight %		
	Type 1	Type 2	Type 3
3/8 in. (9.5 mm)	100	100	100
No. 4 (4.75 mm)	100	90 to 100	70 to 90
No. 8 (2.36 mm)	90 to 100	65 to 90	45 to 70
No. 16 (1.18 mm)	65 to 90	45 to 70	28 to 50
No. 30 (600 μm)	40 to 60	30 to 50	19 to 34
No. 50 (300 μm)	25 to 42	18 to 30	12 to 25
No. 100 (150 μm)	15 to 30	10 to 21	7 to 18
No. 200 (75 μm)	10 to 20	5 to 15	5 to 15

the International Slurry Surfacing Association (ISSA) Bulletin No. 139.

5.4 Composition of Slurry Seal Mixtures:

5.4.1 A job mixture shall be selected that conforms to the specification limits, and that is suitable for the traffic, climatic conditions, curing conditions, and final use. All materials to be used shall be pretested for their suitability in the mixture as described in Section 6.

5.4.2 The mixture shall attain an initial set in not less than 15 min nor more than 12 h. The setting time may be regulated by the addition of mineral fillers or chemical agents.

5.4.3 The mixture shall be one of three types, whose combined aggregates conform to the gradation requirements of Table 1.

5.4.3.1 Type 1 is suitable to seal cracks, fill voids, and correct surface erosion conditions. The residual asphalt content shall be from 10 to 16 weight % of dry aggregate. It shall be applied at a rate of 3.3 to 5.4 kg/m² (6 to 10 lb/yd²). This type is used on airfields where surface sealing and skid resistance are the primary needs.

5.4.3.2 Type 2 is suitable to fill surface voids, correct severe surface erosion conditions, and provide a minimum wearing surface. The residual asphalt content shall be from 7.5 to 13.5 weight % of dry aggregate. It shall be applied at a rate of 5.4 to 8.2 kg/m² (10 to 15 lb/yd²). This type is used on airfields and pavements that are severely eroded, or have numerous cracks. It may also be used as wearing surface on bituminous base courses or soil-cement bases, or as a sealer on stabilized base courses.

5.4.3.3 Type 3 is suitable to provide a new wearing surface or build up a crown. The residual asphalt content shall be from 6.5 to 12 weight % of dry aggregate. It shall be applied at a rate of 8.2 or more kg/m² (15 or more lb/yd²).

5.4.4 *Consistency Test*—This test is used to determine optimum mix design for aggregate, filler, water, and emulsion. A flow of 2 to 3 cm (1 in.) is considered to be the consistency normally required for a workable field mix (see 6.1).

5.4.5 *Set Time*—This test determines the time required for slurry to reach initial set with paper blot method. A properly mix-designed slurry should be set at the end of 12 h. -h set time is considered acceptable for a quick setting slurry (see 6.2).

5.4.6 *Cure Time*—This test is used to determine initial cohesion of slurry mat and resistance to traffic. A properly designed slurry mix should be completely cured at the end of 24 h after placement (see 6.3).

5.4.7 *Wet Track Abrasion Test*—This test method covers measurement of the wearing qualities of slurry seal under wet abrasion conditions.

NOTE 1—As a guide, slurry shall not show a loss of more than 807.44 g/m² (75 g/ft²).

6. Test Methods for Emulsified Asphalt Slurry Seal

6.1 Consistency Test:

6.1.1 This test method is used to determine the proper consistency (mix design) for a slurry seal mixture.

6.1.2 The consistency test should be performed as a method of determining the optimum mix design (proper ratio of aggregate, filler, water, and emulsion) as related to proper consistency for pavement surface placement. Several mixes are made using dried aggregate and various ratios of portland cement, or hydrated lime and or chemical modifier, water and asphalt emulsion. Mix time shall be for no less than 1 min and not longer than 3 min when mixed at 25 ± 1°C (77 ± 3°F).

NOTE 2—Ideal relative humidity for this test is 50 ± 5 %. Results will vary at different relative humidity values.

6.1.3 Mold, metal or plastic, in the form of a frustum of a cone 38 mm (1½ in.) in diameter at the top, 89 mm (3½ in.) in diameter at the bottom and 76 mm (3 in.) in height (see Test Method C 128 and Fig. 1).

6.1.4 The center of a 228 by 228-mm (9 by 9-in.) piece of 3-mm (1/8-in.) thick metal plate is inscribed with a circle 89 mm (3½ in.) in diameter. Three to four additional circles, each 13 mm (½ in.) greater in diameter than the preceding circle, are inscribed on the metal plate around the center circle.

NOTE 3—Plastic plates are subject to eventual crazing and abrasion loss of the inscribed circles.

6.1.5 The mold as described in 6.1.3 is loosely filled with a test slurry mix and struck off. The mold and contents are then inverted in the center of the metal plate as described in 6.1.4 by placing the inscribed surface of the metal plate on the slurry-filled cone which, while holding cone and plate firmly together, is quickly inverted. The mold is removed and the contents allowed to flow over the inscribed circles until flow of the slurry stops. Project aggregate and emulsion grade are considered essential for proper relevancy of the method.

NOTE 4—Referenced ISSA Technical Bulletin No. 106 titled “Measurement of Slurry Seal Consistency.”⁵

6.2 Set Time:

6.2.1 This test method is used to determine the time required for the slurry mat to reach initial set (resistance to paper blot).

6.2.2 The slurry mix or mixtures that provide the desired consistency shall be repeated to determine their setting characteristics. A mix passing the consistency test is poured onto a 152 by 152-mm (6 by 6-in.) asphalt felt pad (13.6 kg (30 lb) roofing felt) and screeded to 6 mm (¼ in.) thickness using a 6-mm template. At the end of 15 min, at 25 ± 1°C (77 ± 3°F) and 50 ± 5 % relative humidity, a white paper towel or tissue is lightly pressed or blotted on the slurry surface. If no brown stain is transferred to the paper, the slurry is considered set. If a brown stain does appear, repeat the blot procedure at 15-min intervals. After 3 h of blotting, 30-min (or longer) blot intervals would be suitable. Record and report the time required to obtain a stain-free blot as the set time.

6.3 Cure Time:

6.3.1 Total cure of a slurry mat is obtained when complete cohesion between asphalt-coated aggregate particles occurs. A

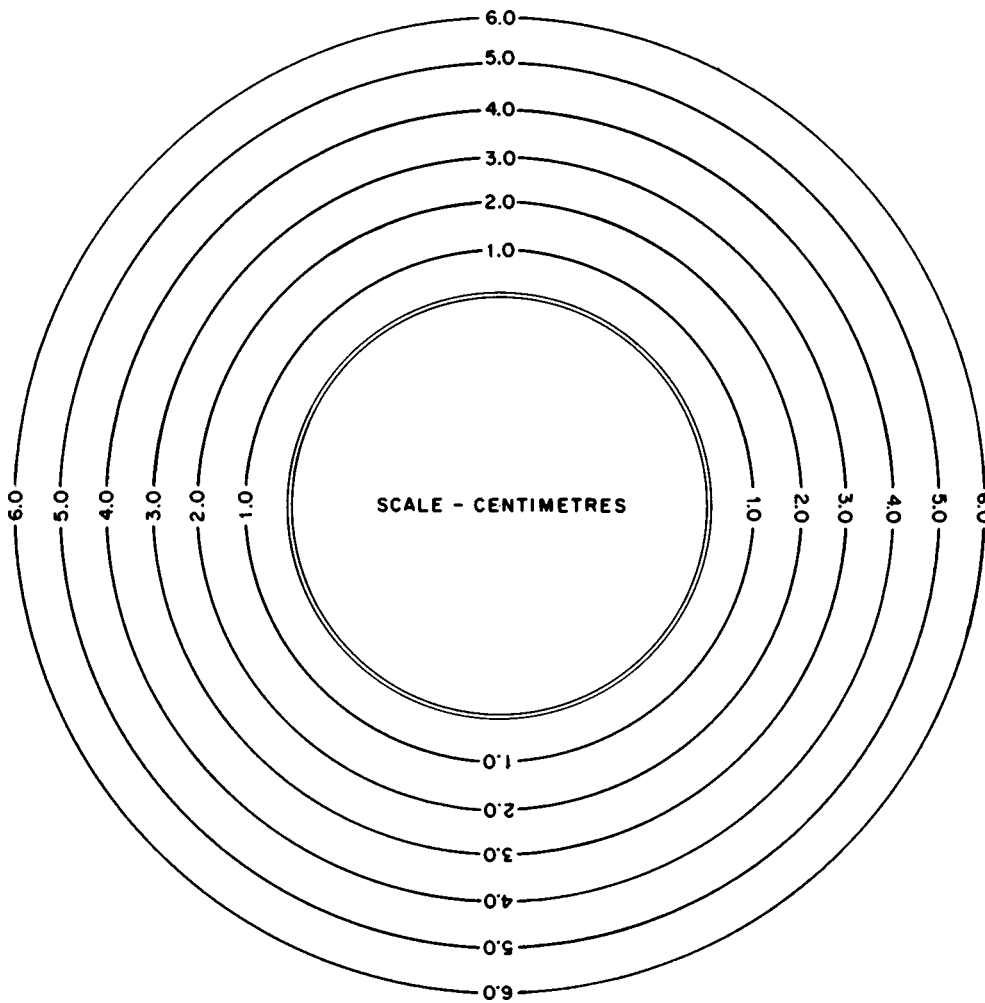

FIG. 1 Cone Consistency Test

cohesion testing device is used to measure cure time.

6.3.2 A slurry mix of optimum design obtained from use of the consistency test (see 5.4.4), is screeded onto a roofing felt pad to a thickness not exceeding the height of the largest aggregate fragment present in the mix. A template is recommended to obtain uniform thickness of the slurry mat.

6.3.3 After set of the slurry mat has occurred (5.4.5), the mat is placed beneath the pneumatically actuated rubber foot (25.4 mm (1 in.) in diameter) of the cohesion tester (see 6.3.4).⁶ A pressure of 193 kPa (28⁵ psi) is considered to be equivalent to that exerted by an average automobile. The rubber foot is twisted by means of a hand torque tester (see 6.3.4) which reads in inch pounds or inch ounces (see Table 2). The torque procedure is repeated at 15–30 min intervals until the highest torque reading obtainable remains constant. An undisturbed site on the slurry pad should be selected for each time-interval test. The time required to reach a constant maximum torque or until the rubber foot rides freely over slurry mat without any aggregate particles being dislodged, is recorded as the cure time.

TABLE 2 Pneumatic Cohesion Tester Chart

psi (on gage)	psi (on foot)	kPa (psi on foot) multiplied by 6.894
4.5	5	34.5
8.9	10	68.9
13.3	15	103.4
17.7	20	137.9
22.1	25	172.4
24.8	28	193.0
26.6	30	206.8
31.0	35	241.3
35.4	40	275.8
39.9	45	310.2
44.3	50	344.7

6.3.4 Cohesion tester⁷ is a lightweight, portable device which can be adjusted to apply varying pressure to a slurry pad (see Figs. 2 and 3). Torque can be applied with a torqometer.⁸ The cohesion tester can be used in the laboratory or field and can be pressured with in-house air, a portable compressor, or a simple bicycle tire pump.

⁷ Available from Benedict Slurry Seal, Inc., 561 Cottingwood Ct., Dayton, OH 45429-3458.

⁸ The Model TQX-2FU Torqometer, available from Snap-On Tools Corp., 2115 S. 162nd St., P.O. Box 46, New Berlin, WI 53151, or equivalent, has been found suitable.

⁶ A suitable rubber foot, having a durometer hardness range of 50 to 70, can be cut from a used automobile tire.

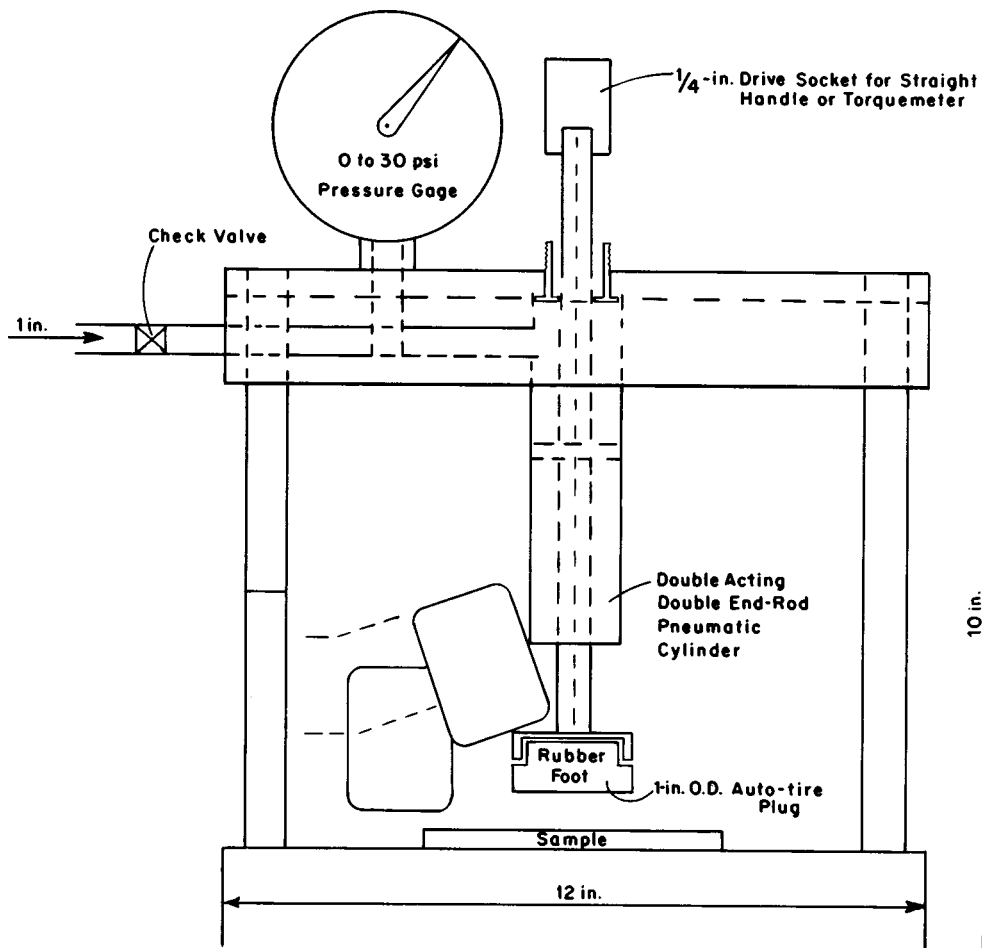

FIG. 2 Cohesion Tester (Front View)

6.4 Wet Track Abrasion Test:

6.4.1 Summary of Test Method:

6.4.1.1 A slurry mixture of fine graded aggregate, asphalt emulsion, and water is prepared to a homogeneous flowing consistency (see consistency test). The slurry is formed into a disk by pouring in the circular opening of a poly(methyl) methacrylate (PMMA) template resting on a larger circlet of 13.62-kg (30-lb) roofing felt.

6.4.1.2 After removal of the template, the disk-shaped specimen is dried to constant weight at 60°C (140°F). The cured slurry is placed in a water bath for 1 h, then mechanically abraded under water with a rubber hose for 5 min. The abraded specimen is washed free of debris, dried at 60°C (140°F) and weighed. The loss in weight expressed as grams per square metre (or square foot) is reported as the wear value (WTAT loss).

6.4.2 Apparatus:

6.4.2.1 *Balance*, capable of weighing 5 000 g to within ± 1.0 g.

6.4.2.2 *Planetary Type Mechanical Stirrer*,⁹ (such as the Hobart Model N-50, Model C-100 or Model A-120 made by the Hobart Manufacturing Co., Troy, Ohio) equipped with a

(5-lb) weighted rubber hose holding device (abrasion head)¹⁰ with about 12.7-mm (1/2-in.) free up-and-down movement in the shaft sleeve (Fig. 4).

6.4.2.3 *Heavy*—(1/8-in.) Flat-Bottom Metal Pan, approximately 330 mm (13 in.) in diameter with 51-mm (2-in.) vertical side walls (20 gage or heavier) having four equispaced screw clamps capable of securing 285 mm (11 1/4 in.) diameter specimen to bottom of pan (Fig. 5).

6.4.2.4 *Suitable Heavy Gage Round Bottom Bowl*, to contain the sample during mixing.

6.4.2.5 *Long-Handled Serving Spoon*, of sufficient length to project 101 mm (4 in.) or more out of the round bottom bowl during stirring.

6.4.2.6 *Disks*, supply of 286-mm (11 1/4-in.) diameter, cut from 13.62-kg (30-lb) roofing felt.

6.4.2.7 *Equipment*, used in specimen preparation such as a special circular poly(methyl) methacrylate (PMMA) template 6 mm (1/4 in.) thick with a 279-mm (11-in.) diameter circular opening (Fig. 6) and a 305 to 355-mm (12 to 14-in.) short handled window squeegee.

⁹ Hobart mixers, Model N-50 and Model A-120, are available from the Hobart Manufacturing Co., Troy, OH 45374. Model C-100 has been discontinued.

¹⁰ Abrasion Head and mixer assembly available from Scan Road Inc., P.O. Box 7677, 4914 Fort Avenue, Waco, TX 76714-7677, and Benedict Slurry Seal, Inc., 561 Cottingwood Ct., Dayton, OH 45429-3458.

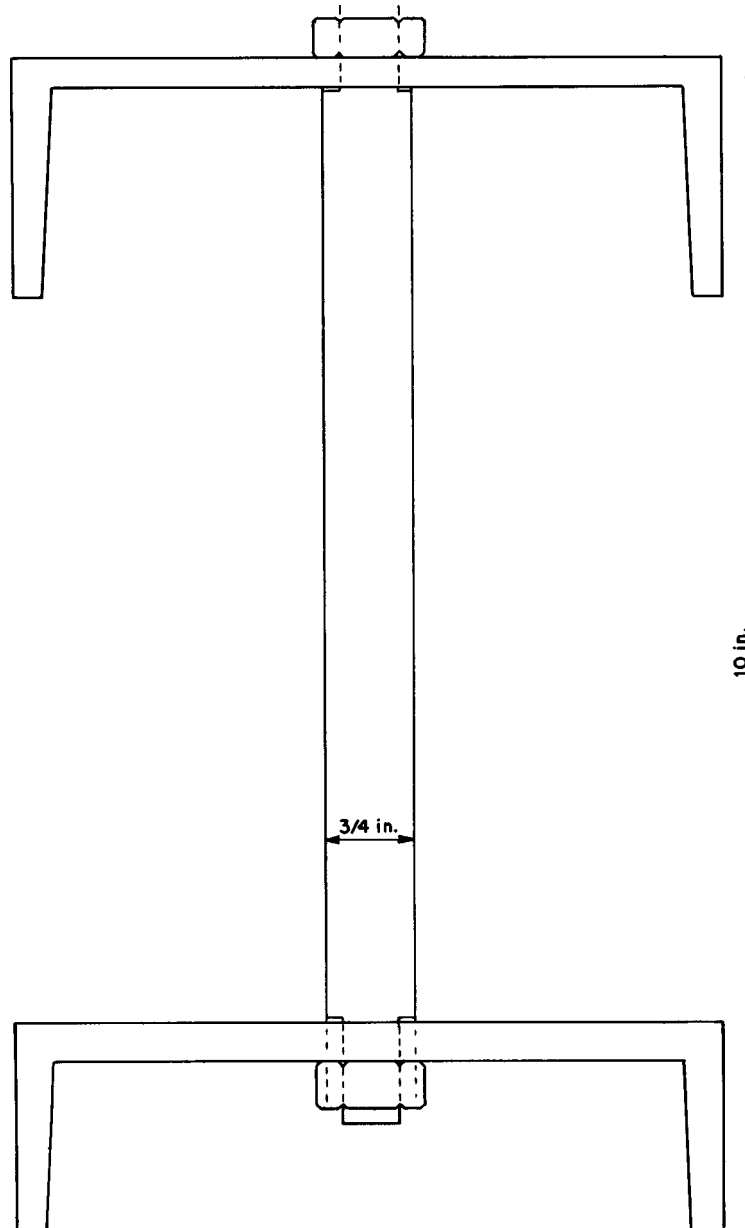

FIG. 3 Cohesion Tester (Side View)

6.4.2.8 *Oven*, forced-draft constant temperature thermostatically controlled at $60 \pm 3^{\circ}\text{C}$ ($140 \pm 5^{\circ}\text{F}$) see Specification E 145 Type II B.

6.4.2.9 *Water Bath*, constant-temperature, controlled at $25 \pm 1^{\circ}\text{C}$ ($77 \pm 2^{\circ}\text{F}$).

6.4.2.10 *Reinforced Rubber Hose*,¹¹ with a 19-mm ($3/4$ -in.) inside diameter and 31-mm ($1\frac{1}{32}$ -in.) outside diameter (two braid, 300 psi, green oil-resistant cover). The hose shall be cut into 127-mm (5-in.) lengths and drilled with two paired 9-mm ($3/8$ -in.) holes aligned on 102-mm (4-in.) centers. Drill holes through convex and concave sides of hose.

6.4.2.11 *Wooden Prop Block* or equivalent for supporting platform assembly into position during testing (see Fig. 7 and Fig. 8).

¹¹ Hose can be obtained from Thaman Rubber Company, 6262 Wiene Road, Cincinnati, OH 45237. Telephone: (513) 631-4303. Refer to Parker #3292-12.

6.4.3 *Preparation of Test Specimen:*

6.4.3.1 The proper ratio of portland cement (or hydrated lime or other additives), water, and asphalt emulsion to the dry weight of the aggregate shall be predetermined in the laboratory or by a functional field mix design previously accepted by project engineer.

6.4.3.2 Quarter a sufficient amount of the air-dried aggregate passing No. 4 sieve to obtain at least 800 g in one quarter.

6.4.3.3 Weigh 800 g of aggregate into mixing bowl. Using the spoon, dry mix the mineral filler into the aggregate for 1 min or until uniformly distributed. Add the predetermined amount of water and mix again for 1 min or until all aggregate particles are uniformly wetted. Finally add the predetermined amount of emulsion and mix for a period of not less than 1 min and not more than 3 min.

6.4.3.4 Placing the opening in the template over the



FIG. 4 Specimen in Place Ready for Test (C-100 machine pictured)

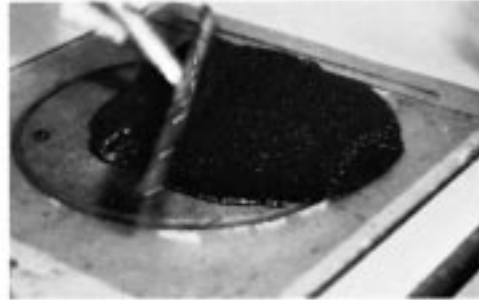

FIG. 6 Squeegee, Slurry into Mold

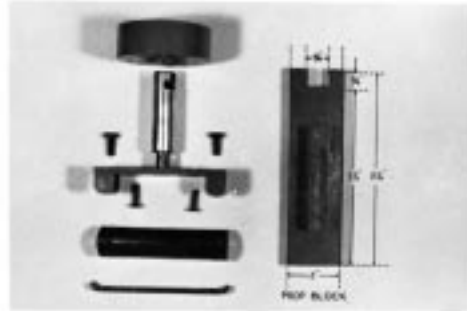

FIG. 7 Components of Abrasion Head (dimensions shown are for the C-100 machine)

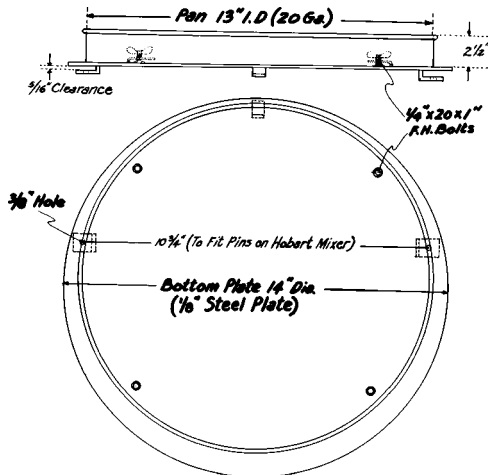

FIG. 5 Diagram of Pan (dimensions shown are for the C-100 machine)

286-mm (11¼-in.) diameter disk of smooth roll roofing. Immediately pour the slurry onto the smooth roll roofing disk.

6.4.3.5 Squeegee the slurry level with the top of the template with minimum of manipulation (excessive squeegeeing contributes to segregation). Scrape off excess material and discard.

6.4.3.6 Remove the template. Place the molded specimen in the 60°C (140°F) oven and dry to constant weight (minimum 15 h drying time).

NOTE 5—It should be noted that if the slurry mix is air-cured prior to oven-drying to a constant weight, the presence of portland cement in the mix could cause the physical properties of the mix to be affected by the relative humidity of the curing environment. A humid environment could increase the degree of hydration of the portland cement and change the physical properties of the mix. When practical, it is suggested that the slurry pad be allowed to cure at a minimum of 50 % relative humidity if optimum effect of the portland cement is desired.

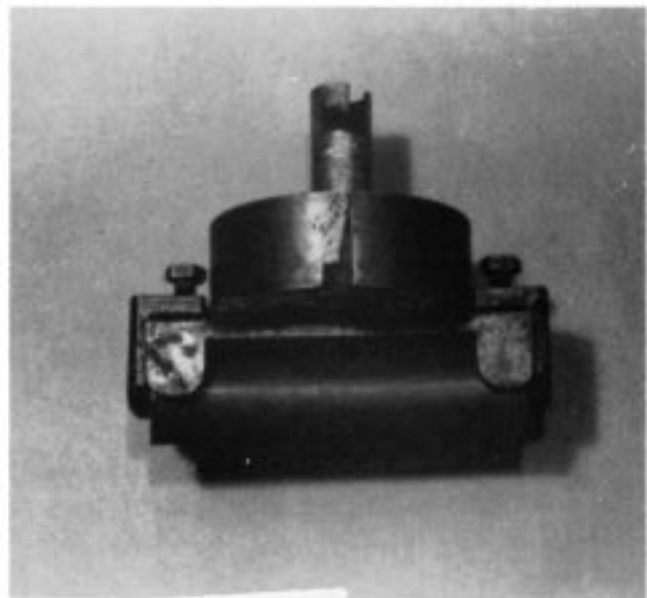

FIG. 8 Assembled Abrasion Head

6.4.4 Procedure:

6.4.4.1 Remove the dried specimen from the 60°C (140°F) oven. Allow to cool to room temperature and weigh.

6.4.4.2 After weighing, place the specimen in the 25°C (77°F) water bath for 60 to 75 min.

6.4.4.3 Remove the specimen from the water bath and place in the 330-mm (13-in.) diameter flat bottom pan. Secure the specimen to the pan bottom by tightening the four wing-nut washers.

6.4.4.4 Completely cover the specimen with at least 6-mm (¼-in.) depth of water (temperature 25°C (77°F)).

6.4.4.5 Secure the pan containing the specimen on the platform of the device (Fig. 4). Lock the rubber hose abrasion head on the shaft of the H machine. Elevate the platform until the rubber hose bears on the surface of the specimen. Use the prop block to support the platform assembly during testing.

6.4.4.6 Switch to the low speed of the mixer. Operate the mixer for 5 min ± 2 s for Hobart Model C-100; 6.7 min ± 2 s for Hobart Model A-120 and 5.15 min ± 2 s for Hobart N-50.

NOTE 6—Install a fresh section of hose after completion of each test. It is permissible to rotate the hose one half turn after each test run and obtain a fresh section for the next specimen.

6.4.4.7 Remove the specimen from the pan after the abrasion cycle and wash off debris. Place the washed test specimen in the 60°C (140°F) oven and dry to constant weight.

6.4.4.8 The dried specimen is removed from the 60°C (140°F) oven, allowed to reach room temperature and weighed. The difference between this weight and the weight obtained in 5.4.1 is multiplied by the appropriate factor shown in Note 7 to express the loss in grams per square foot or grams per square meter (wear value). The wear value is multiplied by the correction factor to obtain a C-100 wear value for comparison to the limit stated in 5.4.7.

NOTE 7—The factors used to convert the loss for the actual abraded area to a 1-m² or 1-ft² basis with each Hobart mixer is:

Model	Abraded Area	1-ft ²	1-m ²	C-100 Correction Factor
C-100	0.327 ft ²	3.06	32.9	1.00
A-120	0.360 ft ²	2.78	29.9	1.17
N-50	0.287 ft ²	3.48	37.5	0.78

The C-100 correction factor converts A-120 or N-50 wear values to the C-100 wear value.

6.4.5 *Report*—Report the wear value (WTAT loss) in grams per square metre (or grams per square foot).

6.5 *Precision*—No precision statement of these practices have been obtained by statistically designed interlaboratory series of tests. However the question of precision is being considered for possibility of development.

7. Slurry Seal Construction

7.1 *Significance*—The work covered by this procedure consists of furnishing all labor, equipment, and materials and performing all operations necessary in connection with the proper application of an emulsified asphalt slurry seal upon the designated surface.

7.2 *Equipment*:

7.2.1 *General*—All equipment, tools and machines used in the performance of this work shall be maintained in satisfactory working order at all times.

7.2.2 *Slurry Mixing Equipment*:

7.2.2.1 The slurry mixing machine shall be a continuous flow mixing unit and capable of delivering accurately a predetermined proportion of aggregate water and asphalt emulsion to the mixing chamber and to discharge the thoroughly mixed product on a continuous basis. The equipment shall be capable of prewetting the aggregate immediately prior to mixing with the emulsion. The mixing unit of the mixing

chamber shall be capable of thoroughly blending all of the ingredients together without violent mixing.

7.2.2.2 The mixing machine shall be equipped with an approved fines feeder that includes an accurate metering device or method to introduce a predetermined proportion of mineral filler into the mixer. The mineral filler shall be fed at the same time and location as the aggregate. The fines feeder shall be required whenever added mineral filler is a part of the aggregate blend.

7.2.2.3 The mixing machine shall be equipped with a water pressure system and fog-type spray bar, adequate for complete fogging of the surface receiving slurry treatment.

7.2.3 *Slurry Spreading Equipment*—Attached to the mixer machine shall be a mechanical type squeegee distributor, equipped with flexible material in contact with the surface of the pavement to prevent loss of slurry from the distributor. It shall be maintained so as to prevent loss of slurry on varying grades and crown by adjustments to insure uniform spread. There shall be a steering device and a flexible strike-off. The spreader box shall have an adjustable width. The box shall be kept clean and build up of asphalt and aggregate on the box or in the corners shall not be permitted. Use of burlap drags or other drags shall be approved by the engineer.

7.2.4 *Auxiliary Equipment*—Hand squeegees, shovels, and other equipment shall be provided if necessary to perform the work.

7.2.5 *Cleaning Equipment*—Power brooms, power blowers, air compressors, water flushing equipment, and hand brooms, suitable for cleaning the surface and cracks of the old surface.

7.3 *Preparation of Surface*:

7.3.1 Immediately prior to applying the slurry, clean the surface of all loose material, mud spots, vegetation, and other objectionable material. Any standard cleaning method used to clean pavements will be acceptable except water flushing will not be permitted in areas where cracks are present in the pavement surface.

7.3.2 If the slurry is being placed over a brick or concrete surface, high-absorbent asphalt surface, or over a surface where the aggregate has become exposed and is polished and slick, a one-part emulsion, three-part water tack coat of the same asphalt emulsion type grade as specified for the slurry is recommended. This can be applied with an asphalt distributor or a suitable water truck. The normal application rate is 0.189 to 0.378 L (0.05 to 0.10 gal) of the diluted emulsion per square yard of surface.

7.4 *Composition of the Slurry Mix*—The amount of asphalt emulsion to be blended with the aggregate shall be that as determined by laboratory mix design after final adjustment in the field. A minimum amount of water shall be added as necessary to obtain a fluid and homogeneous mixture.

7.5 *Weather Limitations*—The slurry seal shall not be applied if either the pavement or air temperature is below 13°C (55°F) and falling, but may be applied when both the air and pavement temperature is 7°C (45°F) or above and rising. The mixture shall not be applied if high-relative humidity prolongs the curing beyond a reasonable time.

7.6 *Traffic Control*—Suitable methods, should be used to protect the slurry from all types of traffic until sufficiently

cured to accept traffic. The length of time before traffic is permitted to use the surface depends on the type of emulsified asphalt, mixture characteristics, and weather conditions.

7.7 Aggregate—The aggregate shall be stockpiled in an area that drains readily. Precautions shall be taken to prevent contamination of the stockpile by oversized rock, soil, or vegetation. The aggregate shall be loaded on to the slurry seal trucks without segregation.

7.8 Asphalt Emulsion—The asphalt emulsion shall be stored in stationary, rail, or truck tanks that can easily be used to fill the slurry seal truck tanks. The tanks shall be equipped to prevent water from entering the emulsion. Suitable heat shall be provided if necessary to prevent freezing. Emulsified asphalts should be mixed or circulated once a day for uniformity.

7.9 Water—All water used with the slurry mixture shall be potable and free of harmful soluble salts.

7.10 Application:

7.10.1 General—The surface may be prewetted by fogging ahead of the slurry box if required by local conditions. Water used in prewetting the surface shall be applied at such a rate that the entire surface is damp with no apparent flowing water in front of the slurry box. The slurry mixture shall be of the desired consistency upon deposit on the surface and no additional elements shall be added. Total time of mixing shall not exceed 4 min. A sufficient amount of slurry shall be carried in all parts of the spreader at all times so that a complete coverage is obtained. Overloading of the spreader shall be avoided. No lumping, balling, or unmixed aggregate shall be

permitted. No segregation of the emulsion and aggregate fines from the coarse aggregate shall be permitted. If the coarse aggregate settles to the bottom of the mix the slurry shall be removed from the pavement. No excessive breaking of emulsion shall be allowed in the spreader box. No streaks, such as those caused by oversized aggregate will be left in the finished pavement.

7.10.2 Joints—Build-up on longitudinal and transverse joints should be kept to a minimum.

7.10.3 Hand Work—Approved squeegees shall be used to spread slurry in nonaccessible areas to the slurry mixer. Care should be exercised in leaving no unsightly appearance from the hand work.

7.10.4 Curing—Treated areas shall be allowed to cure until such time as the engineer or contracting officer permits their opening to traffic.

7.10.5 Rolling—Rolling is normally not required on slurry surfaces. However, in areas of slow turning traffic, for example, airfields, the paved surface should be rolled with a 4.5-metric ton (5-ton) roller. The paved area should be subjected to a minimum of five coverages. If a pneumatic roller is used it should be operated at a tire pressure of 345 kPa (50 psi).

8. Keywords

8.1 abrasion resistance; appropriate ratio-mix formula; emulsified asphalt cold mixture; fine-graded aggregate; mineral filler; mixing water; set and cure time; specialized mixing and application equipment; slurry consistency; slurry seal

The American Society for Testing and Materials takes no position respecting the validity of any patent rights asserted in connection with any item mentioned in this standard. Users of this standard are expressly advised that determination of the validity of any such patent rights, and the risk of infringement of such rights, are entirely their own responsibility.

This standard is subject to revision at any time by the responsible technical committee and must be reviewed every five years and if not revised, either reapproved or withdrawn. Your comments are invited either for revision of this standard or for additional standards and should be addressed to ASTM Headquarters. Your comments will receive careful consideration at a meeting of the responsible technical committee, which you may attend. If you feel that your comments have not received a fair hearing you should make your views known to the ASTM Committee on Standards, 100 Barr Harbor Drive, West Conshohocken, PA 19428.