



# Standard Test Method for Determination of Formaldehyde and Other Carbonyl Compounds in Air (Active Sampler Methodology)<sup>1</sup>

This standard is issued under the fixed designation D 5197; the number immediately following the designation indicates the year of original adoption or, in the case of revision, the year of last revision. A number in parentheses indicates the year of last reapproval. A superscript epsilon ( $\epsilon$ ) indicates an editorial change since the last revision or reapproval.

## 1. Scope

1.1 This test method covers a procedure for the determination of formaldehyde (HCHO) and other carbonyl compounds (aldehydes and ketones) in air. Other carbonyl compounds that have been validated for determination by this method include acetaldehyde, acetone, propanal (propionaldehyde), methacrolein, 2-butanone (methyl ethyl ketone), butyraldehyde, benzaldehyde, isovaleraldehyde, valeraldehyde, o-tolualdehyde, m-tolualdehyde, p-tolualdehyde, hexanal, and 2,5-dimethylbenzaldehyde. Acrolein and crotonaldehyde may be quantified with good accuracy following special precautions (see 10.2.5).

1.2 This test method involves drawing air through a cartridge containing silica gel coated with 2,4-dinitrophenylhydrazine (DNPH) reagent. Carbonyl compounds readily form stable derivatives with the DNPH reagent. The DNPH derivatives are analyzed for parent aldehydes and ketones utilizing high performance liquid chromatography (HPLC). The sampling procedure is a modification of U.S. EPA Method TO-11A (see 2.2).

1.3 This test method is based on the specific reaction of carbonyl compounds with DNPH in the presence of an acid to form stable derivatives according to the reaction shown in Fig. 1, (where: both  $R$  and  $R^1$  are alkyl or aromatic groups (ketones), or both, or either  $R$  or  $R^1$  is a hydrogen atom (aldehydes)). The determination of formaldehyde and other carbonyl compounds, as DNPH derivatives, is similar to that of U.S. EPA Method TO-11A in that it utilizes HPLC with UV detection as the analytical finish. The detection limits have been extended to other carbonyl compounds that can be determined as outlined in Section 10.2.4. This test method is suitable for determination of formaldehyde and other carbonyl compounds in the concentration range from approximately 10 ppb to 1 ppm (v/v).

1.4 The sampling method gives a time-weighted average (TWA) sample. It can be used for long-term (1 to 24 h) or short-term (5 to 60 min) sampling of air for formaldehyde.

1.5 This test method instructs the user on how to prepare sampling cartridges from commercially available chromatographic grade silica gel cartridges<sup>2</sup> by the application of acidified DNPH to each cartridge.

1.6 The sampling flow rate, as described in this test method, has been validated for sampling rates up to 1.5 L/min. This flow rate limitation is principally due to the high pressure drop (>8 kPa at 1.0 L/min) across the user prepared silica gel cartridges which have a particle size of 55 to 105  $\mu\text{m}$ . These cartridges are not generally compatible with battery-powered pumps used in personal sampling equipment (for example, those used by industrial hygienists).

1.7 Alternatively, pre-coated DNPH silica gel cartridges are also commercially available and may be substituted provided they can be demonstrated to perform equivalently.<sup>3</sup> Some of these use silica gel of a larger particle size that results in a lower pressure drop across the cartridge. These low pressure drop cartridges may be more suitable for sampling air using battery-powered personal sampling pumps.

1.8 The values stated in SI units are to be regarded as the standard.

1.9 *This standard does not purport to address all of the safety concerns, if any, associated with its use. It is the responsibility of the user of this standard to establish appropriate safety and health practices and determine the applicability of regulatory limitations prior to use.*

## 2. Referenced Documents

### 2.1 ASTM Standards:

D 1193 Specification for Reagent Water<sup>4</sup>

D 1356 Terminology Relating to Sampling and Analysis of Atmospheres<sup>5</sup>

D 3195 Practice for Rotameter Calibration<sup>5</sup>

<sup>2</sup> The cartridge used in the development and performance evaluation of this test method was the Sep-Pak Plus Silica cartridge. The sole source of supply of the cartridge known to the committee at this time is Waters Associates, 34 Maple Street, Milford, MA 01757. If you are aware of alternative suppliers, please provide this information to ASTM Headquarters. Your comments will receive careful consideration at a meeting of the responsible technical committee,<sup>1</sup> which you may attend.

<sup>3</sup> Tejada, S. B., "Evaluation of Silica Gel Cartridges Coated in situ with Acidified 2,4-Dinitrophenylhydrazine for Sampling Aldehydes and Ketones in Air," *International Journal of Environmental Analytical Chemistry*, Vol 26, 1986, pp. 167–185.

<sup>4</sup> *Annual Book of ASTM Standards*, Vol 11.01.

<sup>5</sup> *Annual Book of ASTM Standards*, Vol 11.03.

<sup>1</sup> This test method is under the jurisdiction of ASTM Committee D22 on Sampling and Analysis of Atmospheres and is the direct responsibility of Subcommittee D22.05 on Indoor Air.

Current edition approved April 10, 2003. Published July 2003. Originally approved in 1991. Last previous edition approved in 1997 as D 5197 – 97.

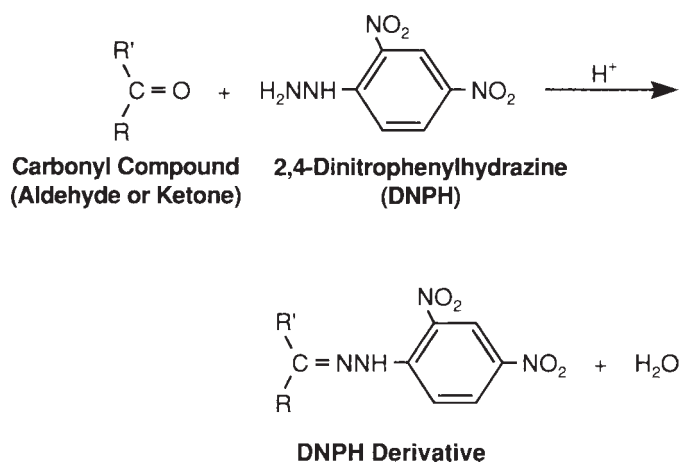

**FIG. 1 Reaction of Carbonyl Compounds**

D 3631 Test Methods for Measuring Surface Atmospheric Pressure<sup>5</sup>

D 3686 Practice for Sampling Atmospheres to Collect Organic Compound Vapors (Activated Charcoal Tube Adsorption Method)<sup>5</sup>

E 177 Practice for Use of the Terms Precision and Bias in ASTM Test Methods<sup>6</sup>

E 682 Practice for Liquid Chromatography Terms and Relationships<sup>7</sup>

### 2.2 EPA Methods:

Method TO-11A, EPA-625/R-96/010b, Compendium of Methods for the Determination of Toxic Organic Compounds in Ambient Air, U.S. Environmental Protection Agency, Research Triangle Park, NC, January 1999<sup>8</sup>

EPA-600/R-98/004, Quality Assurance Handbook for Air Pollution Measurement Systems, Volume 2, Part 1—Ambient Air Quality Monitoring Program Quality System Development, U.S. Environmental Protection Agency, Research Triangle Park, NC, August 1998<sup>8</sup>

EPA-600/4-83-027, Technical Assistance Document for Sampling and Analysis of Toxic Organic Compounds in Ambient Air, U.S. Environmental Protection Agency, Research Triangle Park, NC, June 1983 (PB90-187 014/AS)<sup>8</sup>

## 3. Terminology

### 3.1 Definitions:

3.1.1 For definitions of terms used in this test method, refer to Terminology D 1356 and Practice E 682.

### 3.2 Definitions of Terms Specific to This Standard:

3.2.1 All other pertinent abbreviations and symbols are defined when first cited in this test method.

<sup>6</sup> Annual Book of ASTM Standards, Vol 14.02.

<sup>7</sup> Annual Book of ASTM Standards, Vol 14.01.

<sup>8</sup> Available from the U.S. Environmental Protection Agency, <http://www.epa.gov/ttn/amtic/airtox.html>, or the U.S. Department of Commerce, National Technical Information Service, 5285 Port Royal Rd., Springfield, VA 22161.

## 4. Summary of Test Method

4.1 A known volume of indoor air is drawn through a prepacked silica gel cartridge coated with acidified DNPH, at a sampling rate of 0.5 to 1.2 L/min for an appropriate period of time. Both sampling rate and time are dependent upon carbonyl concentrations in the test atmosphere.

4.2 After sampling, the sample cartridges are individually capped and placed in individual bottles or other sealable containers. Sample identifying tags or labels are attached and the individual sample containers are then placed in a friction-top can or other suitable sealable secondary container with a pouch of charcoal for transport to the laboratory for analysis. The cartridges are placed in cold storage until analysis. Alternatively, the cartridges may be desorbed, diluted to a known volume, and refrigerated until analysis.

NOTE 1—A heat-sealable foil-lined plastic pouch of the type included with some commercial pre-coated DNPH cartridges may be used for storing a DNPH-coated cartridge after sampling, if appropriate.

4.3 The DNPH-carbonyl derivatives are determined using a gradient HPLC system, equipped with a C-18 reverse phase column and an ultraviolet (UV) absorption detector operated at 360 nm.

4.4 A blank cartridge is likewise desorbed and analyzed in accordance with 4.3.

4.5 Formaldehyde and other carbonyl compounds in the sample are identified and quantified by comparison of their retention times and peak heights or peak areas of their corresponding DNPH derivatives with those of standard solutions.

## 5. Significance and Use

5.1 This test method provides an analytical procedure for measuring formaldehyde and other carbonyl compounds in indoor or outdoor air.

## 6. Interferences

6.1 The solid sorbent sampling procedure is specific for sampling and analysis of carbonyl compounds. Interferences in this test method are certain isomeric aldehydes or ketones that may be unresolved by the HPLC system or coelute with DNPH derivatives of other aldehydes and ketones in the sample. Organic compounds that have the same retention time and significant absorbance at 360 nm as the DNPH derivatives of some carbonyl compounds will interfere. Such interferences can often be overcome by altering the separation conditions (for example, using alternative HPLC columns or mobile phase compositions).

6.2 Formaldehyde contamination of the DNPH reagent is a frequently encountered problem. The DNPH must be purified by multiple recrystallizations in UV-grade acetonitrile. Recrystallization is accomplished, at 40 to 60°C, by slow evaporation of the solvent to maximize crystal size. The purified DNPH crystals are stored under UV-grade acetonitrile until use. Impurity levels of carbonyl compounds in the DNPH are determined prior to use by HPLC and should be less than 0.15 µg per cartridge.

6.3 Exposure of the DNPH-coated sampling cartridges to direct sunlight may produce artifacts and should be avoided.<sup>9</sup>

6.4 Ozone at high concentrations (~120 ppb and above) has been shown to interfere negatively by reacting with both the DNPH and its carbonyl derivatives (hydrazones) in the cartridge.<sup>10</sup> The extent of interference depends on the temporal variations of both the ozone and the carbonyl compounds and the duration of sampling. Significant (~45 %) negative interference from ozone was observed even at concentrations of formaldehyde and ozone typical of clean ambient air (2 and 40 ppbv, respectively) when air was sampled for three hours at 1 L/min. It is highly recommended that ozone be removed by means of the devices described in 6.4.2 and 6.4.4 before the sample reaches the cartridge.<sup>11</sup>

6.4.1 The presence of ozone in the sample stream is readily inferred from the appearance of new compounds with retention times shorter than that of the hydrazone of formaldehyde. Fig. 2 shows chromatograms of samples of a formaldehyde-spiked air stream with and without ozone.

6.4.2 The most direct solution to the ozone interference is to remove the ozone before the sample stream reaches the cartridge. This process entails constructing an ozone denuder or scrubber and placing it in front of the cartridge. The denuder is constructed of 1 m of 0.64-cm outside diameter by 0.46-cm inside diameter copper tubing, that is filled with a saturated

solution of KI in water, allowed to stand for a few minutes (~5), drained and dried with a stream of clean air or nitrogen for about 1 h. The capacity of the ozone denuder as described is about 100 ppm(v)-hour of ozone.

6.4.3 Test aldehydes (formaldehyde, acetaldehyde, propionaldehyde, benzaldehyde, and *p*-tolualdehyde) that were dynamically spiked into an ambient sample air stream passed through the denuder with practically no losses.

6.4.4 Ozone scrubbers (cartridge filled with granular potassium iodide) are also commercially available from suppliers of pre-coated DNPH cartridges.

6.5 Special procedures must be followed if this test method is to be used for determination of acrolein or crotonaldehyde in air since the hydrazones of these compounds collected on DNPH-coated cartridge have been observed by HPLC to undergo transformation on storage to one or more compounds that have UV spectra suggesting the presence of the DNPH chromophore.<sup>12, 13</sup> However, these daughter compounds can be linked with reasonable certainty to the disappearance of the corresponding parent hydrazones.

## 7. Apparatus

7.1 *Sampling System*, capable of accurately and precisely sampling 0.1 to 1.50 L/min.

NOTE 2—An example of a sampling system for ambient air consisting of a heated manifold/sample inlet, a denuder/cartridge assembly, a flow meter, a vacuum gage/pump, a timer and a power supply is shown in Fig. 3. In operation, ambient air is drawn through the denuder/cartridge assembly with a vacuum pump at a fixed flow rate between 0.1 to 2 Lpm.

NOTE 3—A pressure drop through the user-prepared sample cartridge of about 19 kPa at a sampling rate of 1.5 L/min has been observed. Some commercially available pre-coated cartridges may exhibit lower pressure drops, which will permit the use of battery-operated personal sampling pumps.

7.2 *HPLC System*, consisting of two or more mobile phase reservoirs; a single or a dual high-pressure pump system equipped with a mobile phase gradient programmer, an injection valve (automatic sampler with a 25- $\mu$ L or other convenient loop volume (10  $\mu$ L, 20  $\mu$ L)); a C18 reverse phase (RP) column (25-cm by 4.6-mm inside diameter); a UV detector operating at 360 nm; and a data system or strip chart recorder. A typical gradient HPLC system configuration is shown in Fig. 4.

NOTE 4—Most commercial HPLC analytical systems will be adequate for this application.

7.3 *Stopwatch*.

7.4 *Friction-Top Metal Can (for example, 4-L Paint Can) or Other Suitable Container*, with polyethylene air bubble packing or other suitable padding, to hold and cushion sample vials.

7.5 *Thermometer*, to record temperature.

7.6 *Barometer*, (Refer to Test Methods D 3631).

<sup>9</sup> Grosjean, D., "Ambient Levels of Formaldehyde, Acetaldehyde, and Formic Acid in Southern California: Results of a One-Year Base-Line Study," *Environmental Science & Technology*, Vol 25, 1991, pp. 710-715.

<sup>10</sup> Arnts, R. R., and Tejada, S. B., "2,4-Dinitrophenylhydrazine-Coated Silica Gel Cartridge Method for Determination of Formaldehyde in Air: Identification of an Ozone Interference," *Environmental Science & Technology*, Vol 23, 1989, pp. 1428 to 1430.

<sup>11</sup> Sirju, A., and Shepson, P. B., "Laboratory and Field Evaluation of the DNPH Cartridge Technique for the Measurement of Atmospheric Carbonyl Compounds," *Environmental Science & Technology*, Vol 29, 1995, pp. 384-392.

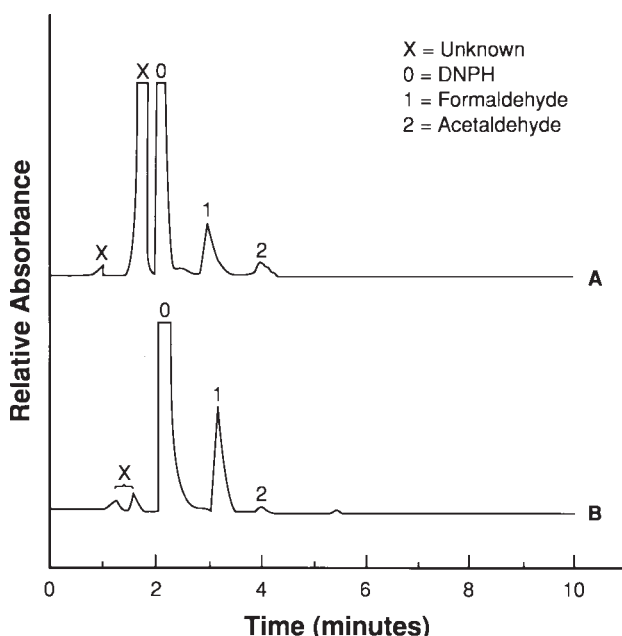

FIG. 2 Cartridge Samples of Formaldehyde in an Air Stream with (A) and without (B) Ozone

<sup>12</sup> Levin, J. O., and Lindahl, R., "Aldehyde Measuring Methods Using DNPH-coated Filters—Summary and Conclusions," *Proceedings of the Workshop "Sampling Project"*, Mol, Belgium, June 27-28, 1986.

<sup>13</sup> Clark, W. L., Biller, W. F., Tejada, S. B., Siegl, W. O., Rosenhamer, D., Newkirk, M. S., and Crowley, R. J., "Round Robin Analysis of Alcohol and Carbonyl Synthetic Exhaust Samples," *SAE Technical Paper Series*, Paper 941944, 1994, pp. 71-87.

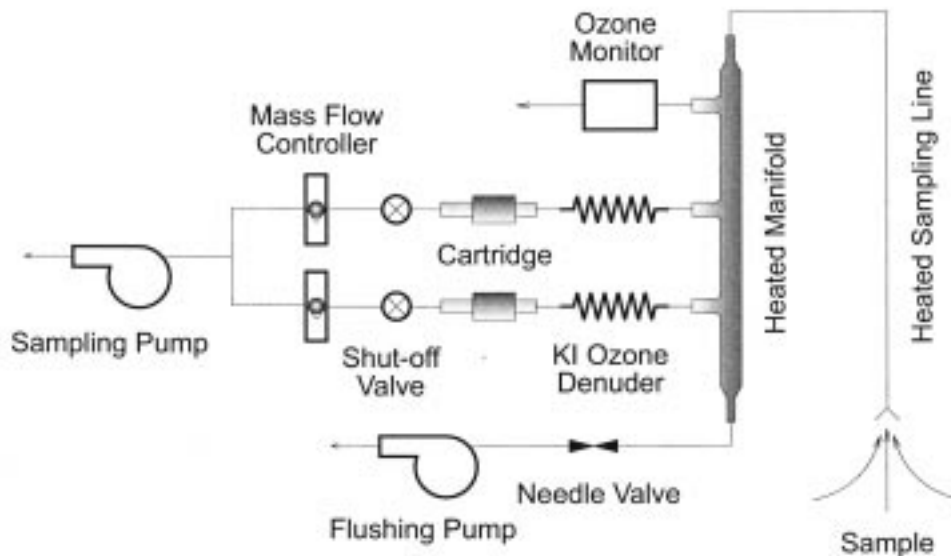

FIG. 3 A Dual-Cartridge Sampling System with Heated Manifold for Carbonyl Compounds in Ambient Air

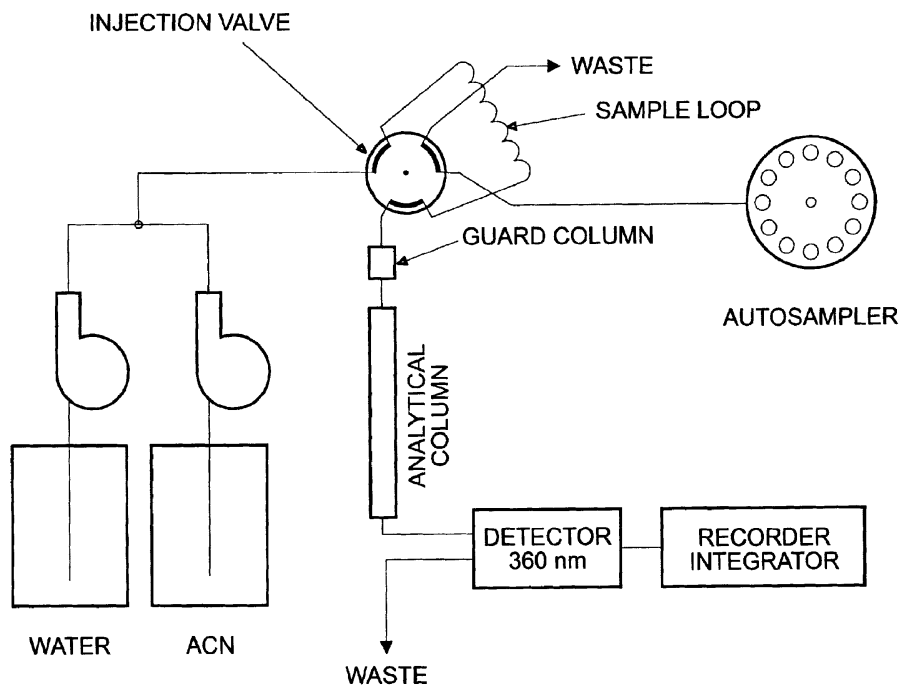

FIG. 4 A Typical Gradient HPLC System Configuration for Determination of Carbonyl Compounds Collected on DNPH Cartridges

7.7 Suction Filtration Apparatus, for filtering HPLC mobile phase.

7.8 Volumetric Flasks, various sizes, 5 to 2000 mL.

7.9 Pipets, various sizes, 1 to 50 mL.

7.10 Helium Purge Line, for degassing HPLC mobile phase (optional).

7.11 Erlenmeyer Flask, 1 L, for preparing HPLC mobile phase.

7.12 Graduated Cylinder, 1 L, for preparing HPLC mobile phase.

7.13 Syringes, for HPLC injection, with capacity at least four times the loop volume (see 7.2).

7.14 Sample Vials.

7.15 Melting Point Apparatus, (optional).

7.16 Rotameters, (Refer to Practice D 3195), Soap Bubble Meter, or Wet Test Meter.

7.17 Graduated Syringes.

7.18 Mass Flowmeters, Mass Flow Controllers, or Other Suitable Device for metering/setting air flow rate of 0.50 to 1.20 L/min through sample cartridge.

7.19 Positive Displacement, Repetitive Dispensing Pipets, 0 to 10-mL range.

7.20 Cartridge Drying Manifold, with multiple standard male syringe connectors (see Fig. 5).

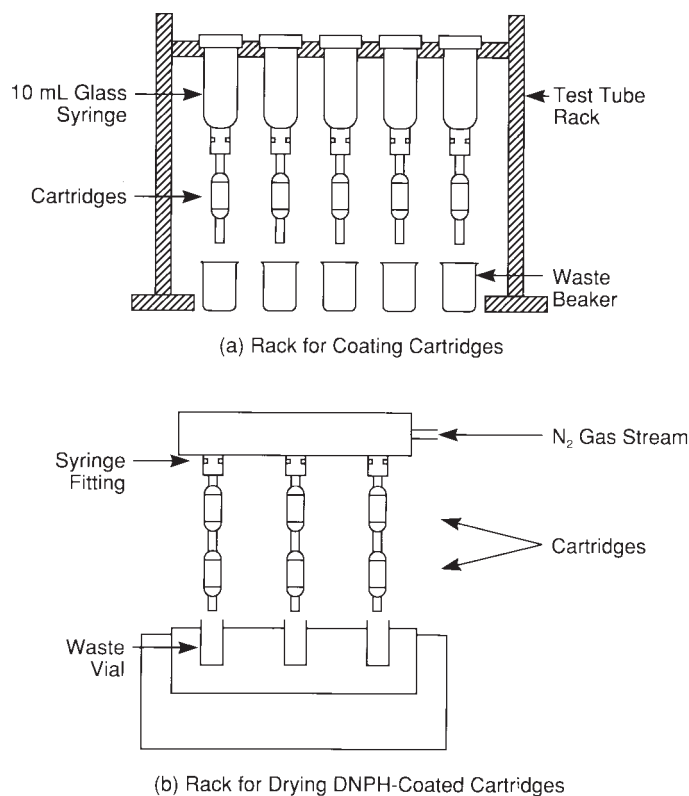

FIG. 5 Syringe Rack for Coating and Drying Sample Cartridges

7.21 *Liquid Syringes*, (polypropylene syringes are adequate) 10 mL, used to prepare DNPH-coated cartridges.

7.22 *Syringe Rack*, made from an aluminum plate (0.16 by 36 by 53-cm) with adjustable legs on four corners. A matrix (5 by 9) of circular holes of diameter slightly larger than the diameter of the 10-mL syringes, symmetrically drilled from the center of the plate, to enable batch processing of 45 cartridges for cleaning, coating, or sample elution, or combination thereof (see Fig. 5).

7.23 *Syringe Fittings/Plugs*, to connect cartridges to the sampling system and to cap prepared cartridges.

7.24 *Hot Plates, Beakers, Flasks, Measuring and Disposable Pipets, Volumetric Flasks*, and so forth, used in the purification of DNPH.

7.25 *Borosilicate Glass Culture Tubes*, (20 by 125 mm) with polypropylene screw caps or other suitable container to transport coated cartridges.

7.26 *Heated Probe*, necessary for when the temperature of sampled air is below 15°C.

7.27 *Cartridge Sampler*, prepacked with silica gel and coated with DNPH in accordance with Section 9, or as commercially available.

7.28 *Polyethylene Gloves*, used to handle silica gel cartridges.

## 8. Reagents and Materials

8.1 *Purity of Reagents*—Reagent grade chemicals shall be used in all tests. Unless otherwise indicated, it is intended that all reagents conform to the specifications of the Committee on

Analytical Reagents of the American Chemical Society where such specifications are available.<sup>14</sup>

8.2 *Purity of Water*—Unless otherwise indicated, references to water shall be understood to mean reagent water as defined by Type II of Specification D 1193.

8.3 *2,4-Dinitrophenylhydrazine (DNPH)*, recrystallized at least twice with UV-grade acetonitrile before use.

8.4 *Acetonitrile*, UV-grade.

8.5 *Perchloric Acid*, 60 %, specific gravity 1.51.

8.6 *Hydrochloric Acid*, 36.5–38 %, specific gravity 1.19.

8.7 *Formaldehyde*, 37 % solution (w/w).

8.8 *Aldehydes and Ketones*, used for preparation of DNPH derivative standards (optional).

8.9 *Ethanol or Methanol*.

8.10 *Silica Gel Solid-Phase Extraction Cartridges*.

8.11 *Nitrogen*, high-purity grade (best source).

8.12 *Charcoal*, granular (best source).

8.13 *Helium*, high-purity grade (best source).

## 9. Preparation of Reagents and Cartridges

NOTE 5—This section is intended for users who desire to prepare their own sampling cartridges by coating prepacked silica gel cartridges with acidified DNPH. Users who intend to purchase DNPH-coated cartridges and DNPH derivative standards from commercial sources may skip any or all portions of this section. Users are cautioned to check that the carbonyl background of the purchased cartridges meet the quality control and accuracy required for their intended applications.

### 9.1 Purification of 2,4-Dinitrophenylhydrazine (DNPH):

**Warning**—This procedure should be performed under a properly ventilated hood and behind a protective shield, as there is an explosion potential and inhalation of acetonitrile can result in nose and throat irritation (brief exposure at 500 ppm) or more serious effects at higher concentrations/longer exposures (see MSDS for more details).

9.1.1 Prepare a supersaturated solution of DNPH by boiling excess DNPH in 200 mL of acetonitrile for approximately 1 h.

9.1.2 After 1 h, remove and transfer the supernatant to a covered beaker on a hot plate and allow gradual cooling to 40 to 60°C.

9.1.3 Maintain the solution at this temperature (40°C) until 95 % of solvent has evaporated.

9.1.4 Decant the solution to waste, and rinse the remaining crystals twice with three times their apparent volume of acetonitrile.

9.1.5 Transfer the crystals to another clean beaker, add 200 mL of acetonitrile, heat to boiling, and again let crystals grow slowly at 40 to 60°C until 95 % of the solvent has evaporated.

9.1.6 Repeat rinsing process as described in 9.1.4.

9.1.7 Take an aliquot of the second rinse, dilute ten times with acetonitrile, acidify with 1 mL of 3.8 M perchloric acid per 100 mL of DNPH solution, and analyze by HPLC, in accordance with 10.2.4.

<sup>14</sup> Reagent Chemicals, American Chemical Society Specifications, American Chemical Society, Washington, DC. For suggestions on the testing of reagents not listed by the American Chemical Society, see *Anal. Standards for Laboratory Chemicals*, BDH Ltd., Poole, Dorset, U.K., and the *United States Pharmacopeia and National Formulary*, U.S. Pharmacopeial Convention, Inc. (USPC), Rockville, MD.

NOTE 6—An acid is necessary to catalyze the reaction of the carbonyls with DNPH. Most strong inorganic acids such as hydrochloric, sulfuric, phosphoric or perchloric acids will perform satisfactorily. Perchloric acid was the preferred catalyst for impinger sampling when using acetonitrile solution of DNPH as the absorbing solution. The DNPH derivatives do not precipitate from solution as readily as when hydrochloric acid is used as the catalyst. This is an ideal situation for an HPLC analytical finish as this minimizes sample handling. For most ambient air sampling, precipitation is not a problem because the carbonyl concentration is generally in the parts per billion range.

9.1.8 An acceptable impurity level in 9.1.7 is  $<0.025 \mu\text{g/mL}$  of formaldehyde DNPH reagent derivative. If the impurity level is not acceptable for intended sampling application, repeat recrystallization.

9.1.9 Transfer the purified crystals to an all-glass reagent bottle, add 200 mL of acetonitrile, stopper, shake gently, and let stand overnight. Analyze the supernatant as in 9.1.7 by HPLC in accordance with 10.2.3.

9.1.10 If the impurity level is not satisfactory, pipet the solution to waste, then add 25 mL of acetonitrile to the purified crystals. Repeat rinsing with 20-mL portions of acetonitrile until a satisfactorily low impurity level in the supernatant is confirmed by HPLC analysis.

9.1.11 If the impurity level is satisfactory, add another 25 mL of acetonitrile, stopper, and shake the reagent bottle, then set aside. The saturated solution above the purified crystals is the stock DNPH reagent.

9.1.12 Maintain only a minimum volume of saturated solution adequate for day-to-day operation. This will minimize waste of purified reagent, should it be necessary to rerinse the crystals to decrease the level of impurity for applications requiring more stringent purity specifications.

9.1.13 Use clean pipets when removing saturated DNPH stock solution for any analytical applications. Do not pour the stock solution from the reagent bottle.

## 9.2 Preparation of DNPH-Formaldehyde Derivative:

9.2.1 To a portion of the recrystallized DNPH add sufficient 2 N HCl to obtain an approximately saturated solution. Add to this solution formaldehyde in molar excess of the DNPH. Filter the DNPH-formaldehyde precipitate, wash it with 2 N HCl and water, and allow it to dry in air.

9.2.2 Check the purity of the DNPH-formaldehyde derivative by melting point ( $166^\circ\text{C}$ ) determination or HPLC analysis. If the impurity level is not acceptable, recrystallize the derivative in ethanol. Repeat the purity check and recrystallization as necessary until an acceptable level of purity (for example, 99 %) is achieved.

9.2.3 The DNPH derivatives of formaldehyde and other carbonyl compounds suitable for use as standards are commercially available both in the form of pure crystals and as individual or mixed stock solutions in acetonitrile.

## 9.3 Preparation of DNPH-Formaldehyde Standards:

9.3.1 Prepare a standard stock solution of the DNPH formaldehyde derivative by dissolving accurately weighed amounts in acetonitrile.

9.3.2 Prepare a working calibration standard mix from the standard stock solution. The concentration of the DNPH formaldehyde derivative in the standard mix solutions should be adjusted to reflect the range of concentrations expected in real samples.

NOTE 7—Individual stock solutions of approximately 100 mg/L are prepared by dissolving 10 mg of the solid derivative in 100 mL of acetonitrile. The individual solution is used to prepare calibration standards containing the derivative of interest at concentrations of 0.5 to 20  $\mu\text{g/mL}$ , that spans the concentration of interest.

9.3.3 Store all standard solutions in tightly capped containers in a refrigerator. They should be stable for several months.

## 9.4 Preparation of DNPH-Coated Cartridges:

NOTE 8—This procedure must be performed in an atmosphere with a very low aldehyde background. All glassware and plasticware must be scrupulously cleaned and rinsed with deionized water and aldehyde-free acetonitrile. Contact of reagents with laboratory air must be minimized. Polyethylene gloves must be worn when handling the cartridges.

### 9.4.1 DNPH Coating Solution:

9.4.1.1 Pipet 30 mL of saturated DNPH stock solution into a 1000-mL volumetric flask, then add 500 mL acetonitrile.

9.4.1.2 Acidify with 1.0 mL of concentrated HCl.

NOTE 9—The atmosphere above the acidified solution should preferably be filtered through a DNPH-coated silica gel cartridge, to minimize contamination from laboratory air. Shake the solution, then make up to volume with acetonitrile. Stopper the flask, invert, and shake several times until the solution is homogeneous. Transfer the acidified solution to a reagent bottle equipped with a 0 to 10-mL range positive displacement dispenser.

9.4.1.3 Prime the dispenser and slowly dispense 10 to 20 mL to waste.

9.4.1.4 Dispense an aliquot solution to a sample vial, and check the impurity level of the acidified solution by HPLC in accordance with 9.1.

9.4.1.5 The impurity level should be  $<0.025 \mu\text{g/mL}$  formaldehyde as the DNPH derivative, similar to that in the DNPH stock solution.

### 9.4.2 Coating of Silica Gel Cartridges:

9.4.2.1 Open the cartridge package, connect the short end to a 10-mL syringe, and place it in the syringe rack. The syringe rack for coating and drying the sample cartridges is illustrated in Fig. 5(a) and Fig. 5(b).

9.4.2.2 Using a positive displacement, repetitive pipet, add 10 mL of acetonitrile to each of the syringes.

9.4.2.3 Let liquid drain to waste by gravity.

NOTE 10—Remove any air bubbles that may be trapped between the syringe and the silica cartridge by displacing them with the acetonitrile in the syringe.

9.4.2.4 Set the repetitive dispenser containing the acidified DNPH coating solution to dispense 7 mL into the cartridges.

9.4.2.5 Once the effluent flow at the outlet of the cartridge has stopped, dispense 7 mL of the coating reagent into each of the syringes.

9.4.2.6 Let the coating reagent drain by gravity through the cartridge until flow at the other end of the cartridge stops.

9.4.2.7 Wipe the excess liquid at the outlet of each of the cartridges with clean tissue paper.

9.4.2.8 Assemble a drying manifold as shown in Fig. 5(b). This contains a previously prepared, DNPH-coated cartridge at each of the exit ports (for example, these scrubber or “guard cartridges” can be prepared by drying a few of the newly coated cartridges in accordance with 9.4.2.9-9.4.2.15 and “sacrificing” these few to ensure the purity of the rest). The “guard cartridges” serve to remove traces of formaldehyde that may be present in the nitrogen gas supply.

9.4.2.9 Insert cartridge connectors (flared at both ends, 0.64 by 2.5-cm outside diameter TFE-fluorocarbon FEP tubing with inside diameter slightly smaller than the outside diameter of the cartridge port) onto the long end of the scrubber cartridges.

9.4.2.10 Remove the cartridges from the syringes and connect the short ends of the cartridges to the open end of the cartridge connectors already attached to the scrubber cartridges.

9.4.2.11 Pass nitrogen through each of the cartridges at about 300 to 400 mL/min.

9.4.2.12 Rinse the exterior surfaces and outlet end of the cartridges with acetonitrile using a Pasteur pipet.

9.4.2.13 After 15 min, stop the flow of nitrogen, wipe the cartridge exterior free of rinse acetonitrile, and remove the dried cartridges.

9.4.2.14 Plug both ends of the coated cartridge with standard polypropylene male syringe plugs and place the plugged cartridge in a borosilicate glass culture tube with polypropylene screw caps.

9.4.2.15 Put a serial number and a lot number label on each of the individual cartridge glass storage containers and refrigerate the prepared lot until use.

## 10. Procedure

### 10.1 Sample Collection:

10.1.1 Assemble the sampling system, and ensure that the pump is capable of constant flow rate throughout the sampling period. The coated cartridges can be used as direct probes and traps for sampling indoor air when the temperature is above 15°C (see 7.26). Add an ozone denuder (see 6.3) if required.

10.1.2 Before sample collection, check the system for leaks. Plug the inlet (short end) of the cartridge so no flow is indicated at the outlet end of the pump. The mass flowmeter should not indicate any air flow through the sampling apparatus.

NOTE 11—The silica gel is held in the cartridge between two fine porosity filter frits. Air flow during sampling could change as airborne particulates deposit on the front frit. The flow change could be significant when sampling particulate-laden atmospheres. For unattended or extended sampling periods, a mass flow controller or, as appropriate, a compensated personal sampling pump is highly recommended to maintain constant flow. The mass flow controller should be set at least 20 % below the maximum air flow through the cartridge.

10.1.3 Install the entire assembly (including a “dummy” sampling cartridge) and check the flow rate at a value near the desired rate. In general, flow rates of 0.5 to 1.2 L/min should be employed. The total moles of carbonyl in the volume of air sampled should not exceed that of the DNPH (2 mg or 0.01 mol/cartridge, 1 to 2 mg/cartridge for commercially available pre-coated cartridges). In general, a safe estimate of the sample size should be approximately 75 % of the DNPH loading of the cartridge (100 to 200 µg as HCHO). Generally, calibration is

accomplished using a soap bubble flowmeter or calibrated wet test meter connected to the flow exit, assuming the system is sealed.

NOTE 12—Test Method D 3686 describes an appropriate calibration scheme that does not require a sealed flow system downstream of the pump.

10.1.4 The operator must measure and record the sampling flow rate at the beginning and end of the sampling period to determine sample volume. If the sampling period exceeds 2 h, the flow rate should be measured at intermediate points during the sampling period. Include a rotameter to allow observation of the flow rate without interruption of the sampling process. Alternatively, a sampling pump which directly measures and continuously records the flow can be used.

10.1.5 Before sampling, remove the glass culture tube from the friction-top metal can or other suitable container. Let the cartridge warm to room temperature in the glass tube before connecting it to the sample train.

NOTE 13—With a commercial pre-coated DNPH cartridge, let the cartridge warm to room temperature before connecting to the sampling train.

10.1.6 Using polyethylene gloves, remove the coated cartridge from the glass tube, remove the syringe plugs, and connect the cartridge to the sampling system with a syringe adapter fitting. Seal the glass tube for later use, and connect the cartridge to the sampling train so that the short end becomes the sample inlet.

NOTE 14—With commercial pre-coated cartridges, follow the manufacturer’s instructions. Some cartridges may be constructed from sealed-glass tubes. For these, break the ends of the cartridge with a tube breaker. Connect the cartridge by inserting the end with the smaller quantity of sorbent to the sampling train so that the larger quantity of sorbent is at the air inlet end. Use care when handling the broken ends.

10.1.7 Turn the sampler on and adjust the flow to the desired rate. A typical flow rate through one cartridge is 1.0 and 0.8 L/min for two cartridges in tandem.

10.1.8 Operate the sampler for the desired period, with periodic recording of the sampling variables.

10.1.9 If the ambient air temperature during sampling is below 15°C, a heated inlet probe is recommended. No pronounced differences have been observed for sampling under various weather conditions—cold, wet, and dry winter months and hot and humid summer months. However, low results may be obtained for formaldehyde and other aldehydes in very dry air (<10 % RH).<sup>15</sup>

10.1.10 At the end of the sampling period, stop the flow. The flow rate must be checked just before stopping the flow. If the flow rates at the beginning and end of the sampling period differ by more than 15 %, the sample should be marked as suspect.

10.1.11 Immediately after sampling, remove the cartridge (using polyethylene gloves) from the sampling system, cap with the original end plugs, and place it back in the original

<sup>15</sup> Grosjean, E. and Grosjean, D., Carbonyl Collection Efficiency of the DNPH-Coated C18 Cartridge in Dry and in Humid Air,” *Environmental Science & Technology*, Vol 30, 1996, pp. 859–863.

labeled glass culture tube. Cap the culture tube, seal it with TFE-fluorocarbon tape, and place it in a friction-top can containing 2 to 5 cm of granular charcoal or styrofoam box with appropriate padding. If appropriate, a heat-sealable foil-lined plastic pouch may be used instead of the glass culture tube for storing the exposed cartridge. Refrigerate the culture tube or pouch containing the exposed sample cartridge until analysis. The refrigeration period prior to analysis should not exceed 30 days.

NOTE 15—If samples are to be shipped to a central laboratory for analysis, the duration of the non-refrigerated period should be kept to a minimum, preferably less than two days.

10.1.12 The average sample flow rate must be calculated from the following equation:

$$Q_A = \frac{Q_1 + Q_2 + \dots + Q_n}{n} \quad (1)$$

where:

$Q_A$  = average flow rate, mL/min,  
 $Q_1, Q_2, \dots, Q_n$  = flow rates determined at beginning, end, and intermediate points during sampling, and  
 $n$  = number of points averaged.

10.1.13 The total flow volume is then calculated using the following equation:

$$V_m = \frac{(T_2 - T_1) \times Q_A}{1000} \quad (2)$$

where:

$V_m$  = total volume, L, sampled at the measured temperature and pressure,  
 $T_2$  = stop time, min,  
 $T_1$  = start time, min,  
 $T_2 - T_1$  = total sampling time, min, and  
 $Q_A$  = average flow rate, mL/min.

10.1.14 The total volume ( $V_m$ ) at standard conditions, 25°C and 101.3 kPa, is calculated from the following equation:

$$V_s = V_m \times \frac{P_A}{101.3} \times \frac{298}{273 + t_A} \quad (3)$$

where:

$V_s$  = total sample volume, L, at 25°C and 101.3-kPa pressure,  
 $V_m$  = total sample volume, L, at measured temperature and pressure,  
 $P_A$  = average pressure, kPa, and  
 $t_A$  = average temperature, °C.

## 10.2 Sample Analysis:

10.2.1 *Sample Storage*—The samples are returned to the laboratory in a friction-top can containing 2 to 5 cm of granular charcoal and stored in a refrigerator until analysis. Alternatively, the samples may also be stored alone in their individual glass containers. The time between sampling and analysis should not exceed 30 days.

### 10.2.2 Sample Desorption:

10.2.2.1 Connect the sample cartridge (inlet or short end during sampling) to a clean syringe.

NOTE 16—The liquid flow during desorption should be in the same direction as the air flow during sampling to prevent insoluble particulates from getting into the eluate. Reverse desorption may be performed if the eluate is filtered prior to HPLC analysis. A filtered blank extract must be analyzed to confirm that no contamination is being introduced by the LC filter.

10.2.2.2 Place the cartridge/syringe in the syringe rack.

10.2.2.3 Desorb the DNPH derivatives of the carbonyls and the unreacted DNPH from the cartridge (gravity feed) by passing 6 mL of acetonitrile from the syringe through the cartridge to a graduated test tube or to a 5-mL volumetric flask.

NOTE 17—A dry cartridge has an acetonitrile holdup volume slightly greater than 1 mL. The eluate flow may stop before the acetonitrile in the syringe is completely drained into the cartridge because of air trapped between the cartridge filter and the syringe adapter tip. If this happens, displace the trapped air with the acetonitrile in the syringe using a long-tip disposable Pasteur pipet.

10.2.2.4 Dilute to the 5-mL mark with acetonitrile. Label the flask with sample identification. Pipet two aliquots into sample vials having TFE-fluorocarbon-lined septa. Analyze the first aliquot for the carbonyl derivatives by HPLC. Store the second aliquot in the refrigerator until the results of the analysis of the first aliquot are complete and validated. The second aliquot can be used for confirmatory analysis, if necessary.

NOTE 18—With commercial pre-coated sampling cartridges, follow the manufacturer's instructions. For glass-sealed DNPH sampling tubes that contain two sorbent beds, uncap the inlet end of the tube, then carefully remove the spring (or other retaining device) and plug of glass wool holding the sorbent layer in place. Empty the sorbent into a clean 4-mL glass vial with TFE-fluorocarbon-lined septum or cap. Mark this as the *primary* sampling section. Carefully remove the next plug of glass wool and empty the remaining sorbent into another 4-mL vial. Mark this as the *back-up* sampling section. Carefully pipette 3 mL acetonitrile into each vial, cap the vials, and let stand for 30 min with occasional agitation.

### 10.2.3 HPLC Analysis:

10.2.3.1 Assemble the HPLC system following the configuration illustrated in Fig. 4 or in accordance with the manufacturer's instructions and calibrate as described in 10.2.4.

10.2.3.2 Operate the HPLC in the isocratic mode if the analytes of interest are limited to the derivatives formaldehyde, acetaldehyde, acetone and propionaldehyde; otherwise, operate the system in the gradient mode. For isocratic separation of formaldehyde, the following parameters can be used:

Column	C18 (4.6-mm inside diameter by 25 cm, or equivalent)
Mobile Phase	60 % acetonitrile/40 % water, isocratic
Detector	ultraviolet, operating at 360 nm
Flow Rate	1.0 mL/min
Retention Time	7 min for formaldehyde with one C18 column. Thirteen min for formaldehyde with two C18 columns
Sample Injection Volume	25 $\mu$ L

Before each analysis, check the detector baseline to ensure stable conditions.

10.2.3.3 The operating parameters found adequate for the separation of the 17 carbonyls within the scope of this test method are as follows:



Column	C18 (4.6-mm inside diameter by 25 cm, or equivalent)		
Column Temperature	25°C		
Mobile Phase	Acetonitrile, Water		
	Linear Gradient Program		
	Time (minutes)	% Acetonitrile	% Water
	0	60	40
	36	75	25
	56	100	0
	57	60	40
	72	60	40
Detector	ultraviolet, operating at 360 nm		
Flow Rate	1.0 mL/min		
Retention Time	~10 min for formaldehyde with two C18 columns in series.		
Sample Injection Volume	25 µL		

10.2.3.4 The gradient program in 10.2.3.3 adequately separates DNPH derivatives of formaldehyde and acetaldehyde; acrolein and its principal transformation product from the derivatives of acetone and propionaldehyde; the derivative of crotonaldehyde from its principal transformation product; the derivative of methacrolein from the derivatives of 2-butanone and butyraldehyde; the derivatives of isovaleraldehyde, valeraldehyde, hexanal, 2,5-dimethylbenzaldehyde; and the isomers of the tolualdehyde derivatives.

10.2.3.5 Chromatographic parameters that have been used in round robin analysis of the carbonyl derivatives participated in by several laboratories have been described in the literature.<sup>16</sup>

NOTE 19—Column manufacturers as well as suppliers of pre-coated DNPH cartridges usually recommend optimal conditions for the separation of DNPH derivatives in reverse-phase columns. These recommendations may eliminate the need for dual columns without compromising resolution of the other carbonyl compounds.

10.2.3.6 Mobile phase solvents should be HPLC-UV grade and should be filtered through a 0.2-µm TFE-fluorocarbon membrane filter in an all-glass and TFE-fluorocarbon suction filtration apparatus. Degas the filtered mobile phase by purging with helium for 10 to 15 min (100 mL/min) or by heating to 60°C for 5 to 10 min in an Erlenmeyer flask covered with a watchglass. An effective degassing alternative is to partially immerse the liquid reservoir in an ultrasonic bath and apply vacuum above the liquid surface.

10.2.3.7 In-line vacuum degassers placed before the HPLC pump are commercially available. These operate by passing the mobile phase through a solvent-inert, semi-permeable membrane coil that allows air to pass through and not the solvent. Air is removed by applying vacuum above the membrane.

10.2.3.8 For HPLC systems not equipped with an inline degasser, a constant back pressure restrictor (350 kPa) or short length (15 to 30 cm) of 0.25-mm inside diameter TFE-fluorocarbon tubing should be placed after the detector to eliminate further mobile phase outgassing.

10.2.3.9 Place the mobile phase(s) in the HPLC solvent reservoir(s) and set the pump at a flow rate of 1.0 mL/min. For isocratic separation, allow it to pump for 20 to 30 min to condition the column before the first analysis. For gradient separation, let the pump run through at least a full gradient

program cycle to condition the column. Display the detector output on a strip chart recorder or similar output device. The detector should be on and warmed for at least 30 minutes before the column conditioning begins.

10.2.3.10 Draw at least 100 µL of the sample into a clean HPLC injection syringe. Fill the HPLC loop (*load* position of valve) by addition of excess sample by means of the syringe. Turn the valve to *inject* position to start the run. Activate the data system simultaneously with the injection, and mark the point of injection on the strip chart recorder.

10.2.3.11 After approximately 1 min, the injection valve is returned to the *load* position and the syringe and valve are rinsed or flushed with acetonitrile/water mixture in preparation for the next sample analysis.

NOTE 20—Do not syringe solvent through the HPLC loop while the valve is in the *inject* position.

10.2.3.12 After elution of the last DNPH-carbonyl derivative (see Fig. 6), terminate data acquisition and calculate the component concentrations as described in Section 11.

10.2.3.13 The carbonyl compounds in the sample are identified and quantified by comparing their retention times and area counts with those of standard DNPH derivatives. Formaldehyde, acetaldehyde, acetone, propionaldehyde, methacrolein, benzaldehyde, isovaleraldehyde, valeraldehyde, and *o*-, *m*-, *p*-tolualdehydes, hexanal and 2,5-dimethylbenzaldehyde can be identified with a high degree of confidence. Acrolein and crotonaldehyde may be confidently quantified following special precautions (see 10.2.5). The identification of butyraldehyde is less certain, because it coelutes with isobutyraldehyde and not sufficiently resolved from 2-butanone (methyl ethyl ketone) under the stated chromatographic conditions. Fig. 7 illustrates a typical chromatogram obtained with the gradient HPLC system.

NOTE 21—After several cartridge analyses, buildup on the column (if indicated, as by increasing pressure from run to run at a given flow and solvent composition) may be removed by flushing with several column volumes of 100 % acetonitrile.

### Operating Parameters, HPLC

Column: C-18 Reverse Phase  
 Mobile Phase: 60% Acetonitrile/40% Water  
 Detector: Ultraviolet, at 360 nm  
 Flow Rate: 1 mL/min.  
 Retention Time: ca. 7 min. for formaldehyde  
 Sample Injection Volume: 25 µL

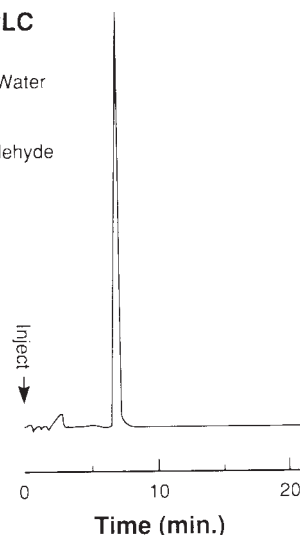

FIG. 6 Example Chromatogram of DNPH-Formaldehyde Derivative

<sup>16</sup> Tejada, S. B., Clark, W., and Biller, W. F., "CRC Carbonyl Emissions Analysis Program," SAE Technical Paper Series, Paper 971609, 1997, pp. 101-119.

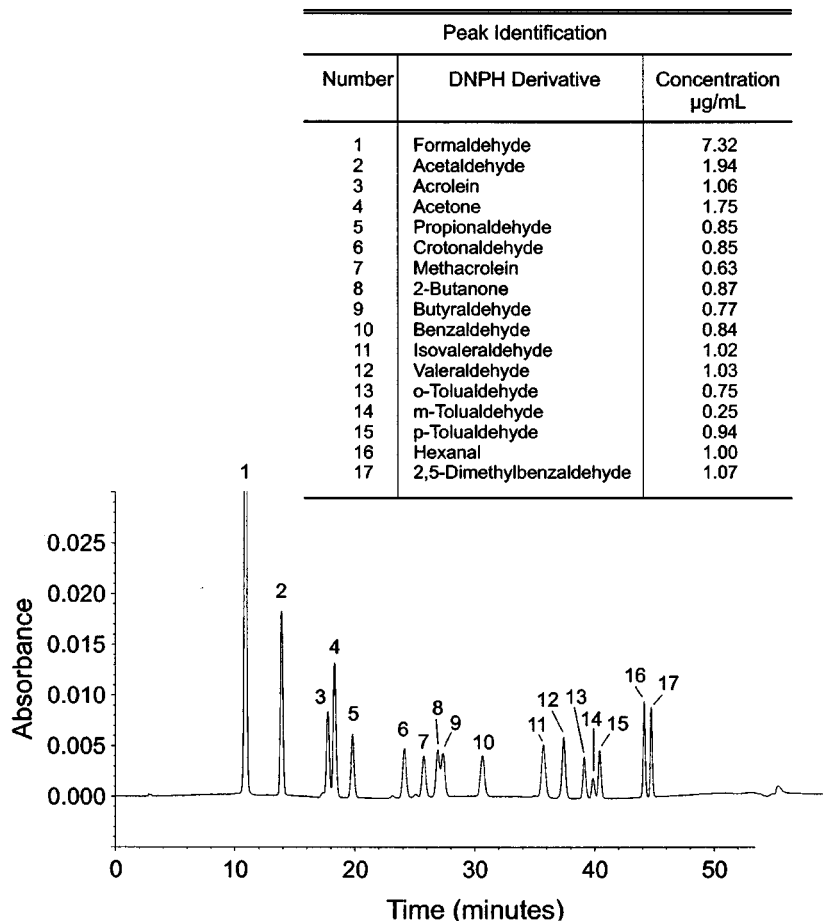

FIG. 7 Typical Chromatographic Separation of DNPH Derivatives of 17 Carbonyl Standards

10.2.3.14 The concentrations of individual carbonyl compounds are determined as outlined in Section 11.

10.2.3.15 After a stable baseline is achieved, the system can be used for another sample injection as previously described.

10.2.3.16 If the concentration of analyte exceeds the linear range of the instrument, the sample should be diluted with mobile phase, or a smaller volume can be injected into the HPLC.

10.2.3.17 If the retention time found in earlier runs is not duplicated ( $\pm 10\%$ ), the acetonitrile/water ratio may be increased or decreased to obtain the correct elution time. If the elution time is too long, increase the ratio; if it is too short, decrease the ratio. If a solvent change is necessary, always recalibrate (see 10.2.4) before running samples.

NOTE 22—The chromatographic conditions described here have been optimized for the detection of formaldehyde and other carbonyls within the scope of this test method. Users are advised to experiment with their HPLC system to optimize chromatographic conditions for their particular analytical needs.

#### 10.2.4 HPLC Calibration:

10.2.4.1 Prepare a calibration standard stock solution of each individual DNPH-carbonyl standard by dissolving accurately weighed amounts (for example, 10 mg) with acetonitrile in a 100 mL volumetric flask. These individual solutions are

used to prepare calibration standards at concentrations spanning the range of interest.

NOTE 23—Purified crystals or solutions of DNPH derivatives of carbonyls are available from commercial sources.

10.2.4.2 Analyze each calibration standard (at least five levels) three times and tabulate area response against mass injected (or, more conveniently, versus the concentration of the DNPH-carbonyl injected, for a fixed loop volume). An example of a multicomponent, six level calibration chromatogram is shown in Fig. 8. Perform all calibration runs as described for sample analyses in 10.2.3. Using the UV detector, a linear response range from approximately 0.5 to 20 µg/mL should be achieved for 25-µL injection volumes. The results may be used to prepare a calibration curve, as illustrated in Fig. 9 for formaldehyde. Linear response is indicated where a correlation coefficient of at least 0.999 for a linear least-squares fit of the data (concentration versus area response) is obtained. The retention times for each analyte should agree within 2%.

10.2.4.3 Once linear response has been documented, an intermediate concentration standard near the anticipated levels of each component, but at least ten times the detection limit, should be chosen for daily calibration. The day to day response for the various components should be within 10% for analyte

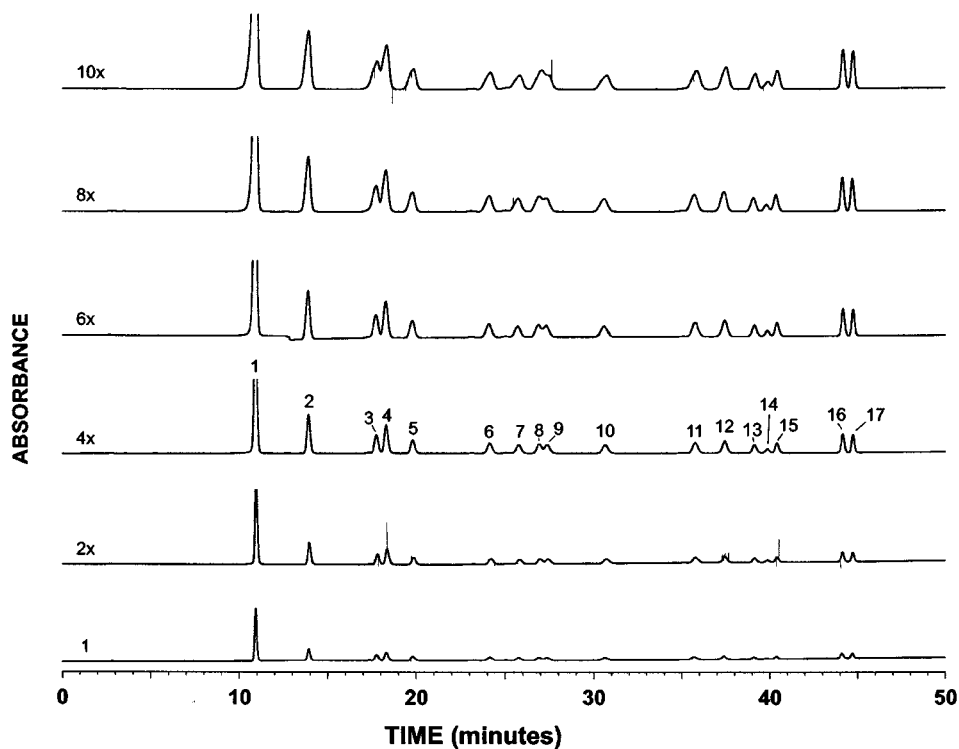

FIG. 8 Typical Six-Level Multiple-Component Standard Calibration Chromatogram

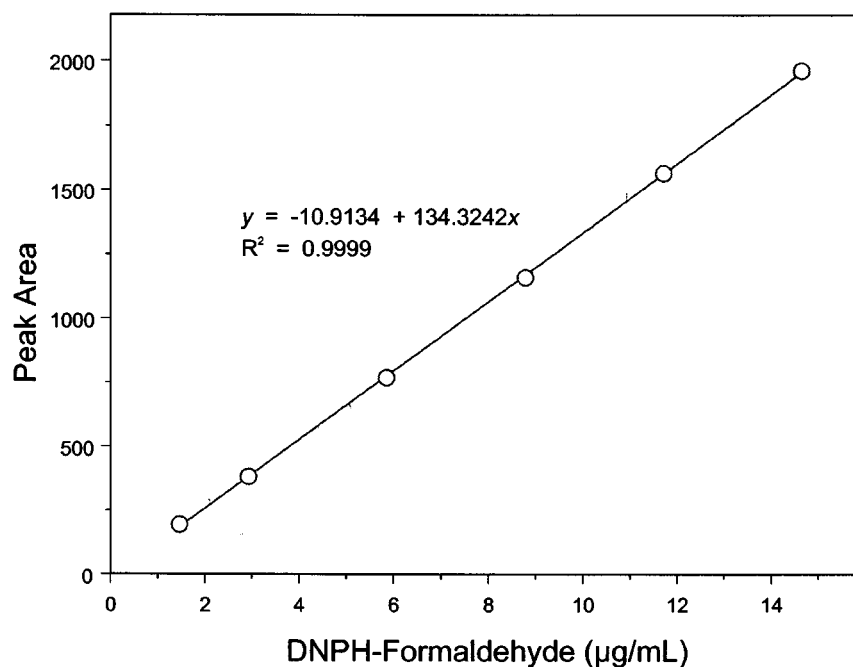

FIG. 9 Example Calibration Curve for Formaldehyde

concentrations of 1 µg/mL or greater and within 15 to 20 % for analyte concentrations near 0.5 µg/mL. If greater variability is observed, recalibration may be required or a new calibration curve must be developed from fresh standards.

10.2.5 Quantitation of Acrolein and Crotonaldehyde

10.2.5.1 In an acidic environment in the presence of excess DNPH, the DNPH derivatives of acrolein and crotonaldehyde have been shown to partially transform into several unknown compounds. The UV spectra of these compounds strongly suggest the presence of the DNPH chromophore, having

maximum absorption in the 355-360 nm range. Therefore, it appears that they are also DNPH derivatives.

10.2.5.2 The long-term stabilities (up to 70 days) of the DNPH derivatives of acrolein and crotonaldehyde has been evaluated by spiking 30 DNPH-coated cartridges with 100  $\mu\text{L}$  of a solution containing the derivatives of acrolein (348  $\text{ng}/\mu\text{L}$ ) and crotonaldehyde (422  $\text{ng}/\mu\text{L}$ ). Three of these spiked cartridges were eluted after about four hours. Three aliquots of each eluate were transferred to separate sampler vials with PTFE-lined septa. Two of the vials were stored in the refrigerator and the third was left on the lab bench at room temperature and was analyzed repeatedly over a 70 day period. Example chromatograms of the eluates from a freshly spiked sample (eluted immediately after spiking) and from the eluates after four hours of spiking are shown in Fig. 10. The rest of the spiked cartridges were stored in the refrigerator for elution and analysis over a period of several weeks. Two cartridges were always eluted in any given day.

10.2.5.3 In the absence of structural information about these compounds, the main transformation products of acrolein and crotonaldehyde derivative are labeled x-acrolein derivative and x-crotonaldehyde derivative respectively. The minor peak labeled Unknown, appear to have originated from both the acrolein and crotonaldehyde derivatives.

10.2.5.4 The stabilities of the components in the 4-hour eluates stored at room temperature for 70 days are shown Table 1 and those in the eluates from the cartridges stored for various duration are shown in Table 2.

10.2.5.5 Comparison of data in Tables 1 and 2 shows that: (1) the derivatives of acrolein and crotonaldehyde are more stable when desorbed early and stored in the eluate (3.8 % and 3.7 % *rsd*, respectively) than when stored in the cartridge

(80.5 % and 96.8 % *rsd*, respectively); (2) the sums of the peak areas of acrolein and the x-acrolein derivatives in the eluate are highly consistent (7.0 % *rsd*), while those in the stored cartridge are not as good (14.4 % *rsd*); (3) the sums of the peak areas of crotonaldehyde and x-crotonaldehyde derivatives are both highly consistent in the cartridge (5.4 % *rsd*) and in the eluate (3.6 % *rsd*); (4) the sums of the peak areas of acrolein, x-acrolein and the unknown derivatives are remarkably consistent in the cartridge (5.2 % *rsd*) and in the eluate (5.2 % *rsd*), while adding the areas of the unknown to the corresponding areas of crotonaldehyde and x-crotonaldehyde derivative showed minor changes in % *rsd* in the cartridge and in the eluate.

10.2.5.6 The internal consistencies of the sums of the peak areas of acrolein, x-acrolein and the unknown derivatives suggests that a reasonably accurate value for acrolein can be obtained if the three components can be separated and unambiguously identified. The same can be said in the case of crotonaldehyde.

10.2.5.7 To quantitate acrolein or crotonaldehyde, a spiking experiment should be performed and the HPLC system optimized to achieve good separation of the components identified in Fig. 10.

10.2.5.8 Apply the response factor of the parent carbonyl derivative to the sum of the peak areas as shown in Tables 1 and 2.

## 11. Calculation

11.1 The total mass of analyte (DNPH-formaldehyde) is calculated for each sample using the following equation:

$$W_d = W_s - W_b \quad (4)$$

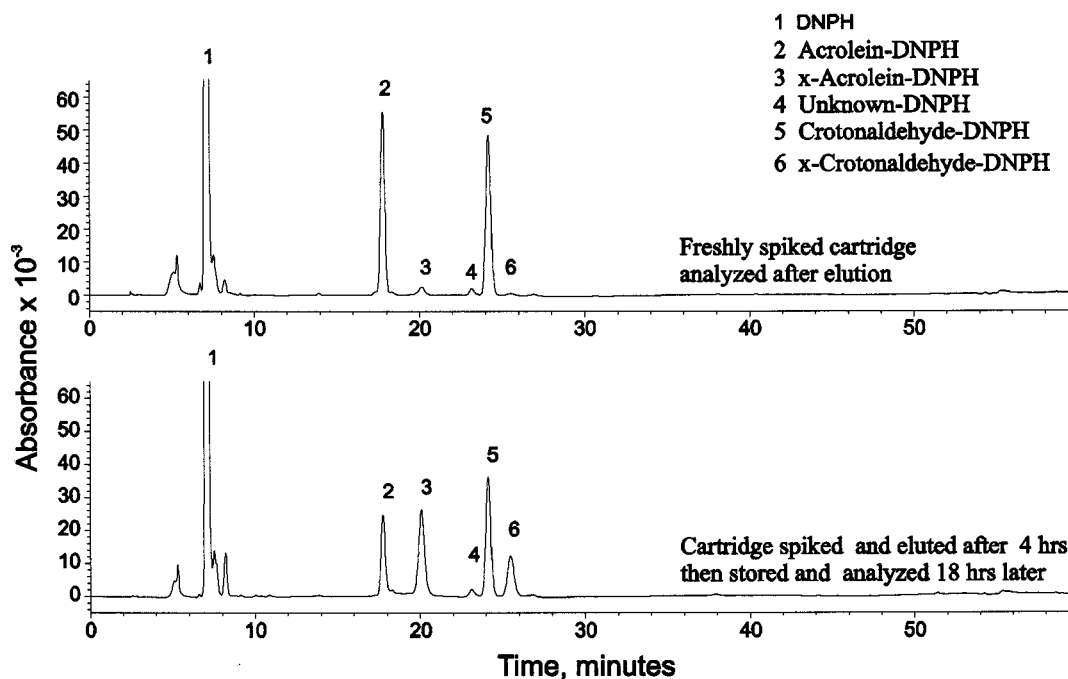

FIG. 10 Optimized Chromatographic Separation of Acrolein and Crotonaldehyde DNPH Derivatives

**TABLE 1 Stability of Extracted Components on Storage of Spiked Cartridges<sup>A</sup>**

Elapsed days after cartridge extraction	Acrolein	x-Acrolein	Unknown	Croton	x-Croton	Acrolein +x-Acrolein	Acrolein +x-Acrolein +Unknown	Croton +x-Croton	Croton +x-Croton +Unknown
1	442.4	685.4	53.5	768.8	343.6	1127.8	1181.3	1112.4	1165.9
1	446.3	697.7	51.0	752.5	375.8	1144.1	1195.1	1128.3	1179.3
1	420.6	637.2	52.3	735.9	352.3	1057.7	1110.0	1088.1	1140.4
2	436.3	697.6	57.9	804.8	381.0	1133.9	1191.8	1185.8	1243.7
7	434.8	664.0	73.4	776.6	332.9	1098.7	1172.1	1109.5	1182.8
8	405.5	575.1	76.4	719.2	323.6	980.6	1057.0	1042.8	1119.2
8	432.0	638.2	78.2	767.4	320.6	1070.2	1148.4	1087.9	1166.1
23	434.5	558.0	112.1	715.6	329.1	992.5	1104.6	1044.8	1156.9
41	454.3	582.4	115.2	771.0	321.3	1036.8	1152.0	1092.3	1207.6
41	452.9	518.1	23.0	774.9	314.3	971.0	994.0	1089.3	1112.3
41	427.0	562.5	109.6	731.4	322.7	989.5	1099.0	1054.2	1163.7
64	464.4	642.0	85.6	778.9	328.5	1106.4	1192.0	1107.3	1192.9
64	471.6	651.7	93.3	794.7	344.0	1123.3	1216.6	1138.6	1231.9
64	433.7	585.1	77.4	727.3	307.6	1018.8	1096.2	1034.9	1112.3
70	455.4	478.0	201.9	793.4	318.0	933.4	1135.3	1111.5	1313.3
70	443.0	484.6	180.2	774.2	304.0	927.6	1107.8	1078.2	1258.4
Average	440.92	603.60	90.05	761.65	332.46	1044.52	1134.57	1094.11	1184.16
Std. dev.	16.65	71.54	46.72	27.99	22.08	73.30	58.74	39.27	55.95
% rsd	3.78	11.85	51.88	3.67	6.64	7.02	5.18	3.59	4.72

<sup>A</sup>Cartridges were extracted ~ 4 hours after spiking with acrolein and crotonaldehyde hydrazones. Extract were stored at room temperature.

**TABLE 2 Stability of Extracted Components on Storage of Spiked Cartridges**

Days cartridge stored before extraction	Acrolein	x-Acrolein	Unknown	Croton	x-Croton	Acrolein +x-Acrolein	Acrolein +x-Acrolein +Unknown	Croton +x-Croton	Croton +x-Croton +Unknown
0	440.9	603.6	100.3	761.7	332.5	1044.5	1144.8	1094.1	1194.4
1	243.9	857.8	84.2	563.0	666.7	1101.7	1186.0	1229.7	1313.9
2	144.7	1009.9	80.0	424.8	896.5	1154.5	1234.5	1321.3	1401.3
4	68.4	952.5	134.3	150.0	1117.7	1020.9	1155.2	1267.7	1402.0
9	117.6	777.4	251.7	190.1	948.3	895.0	1146.7	1138.4	1390.1
16	114.7	787.5	240.9	131.6	1015.1	902.2	1143.1	1146.7	1387.6
30	75.8	680.2	303.8	80.9	1051.2	755.9	1059.7	1132.1	1435.9
45	79.1	787.4	242.6	132.4	1067.3	866.5	1109.0	1199.7	1442.2
58	78.3	693.8	253.3	50.1	1137.2	772.1	1025.3	1187.2	1440.5
71	84.1	785.9	224.3	48.3	1205.2	870.0	1094.3	1253.6	1477.9
Avg	144.76	793.58	191.53	253.27	943.78	938.34	1129.87	1197.05	1388.58
Std. dev.	116.51	122.68	82.80	245.14	262.60	135.59	60.53	71.16	81.25
% rsd	80.49	15.46	43.23	96.79	27.82	14.45	5.36	5.94	5.85

where:

 $W_d$  = corrected quantity,  $\mu\text{g}$ , of DNPH derivative extracted from the cartridge,

 $W_s$  = uncorrected analyte mass,  $\mu\text{g}$ , on the sample cartridge

 $= A_s \times (C_{std}/A_{std}) \times v_s \times d_s$ , and

 $W_b$  = analyte mass,  $\mu\text{g}$ , in the blank cartridge

 $= A_b \times (C_{std}/A_{std}) \times v_b \times d_b$ ,

where:

 $A_s$  = area counts, eluate from sample cartridge,

 $A_b$  = area counts, eluate from blank cartridge,

 $A_{std}$  = area counts, standard,

 $C_{std}$  = concentration ( $\mu\text{g}/\text{mL}$ ) of analyte in the daily calibration standard,

 $v_s$  = total volume (mL) of the sample cartridge eluate,

 $v_b$  = total volume (mL) of the blank cartridge eluate,

 $d_s$  = dilution factor for the sample cartridge eluate

 $= 1$  if sample was not rediluted

 $= v_d/v_a$  if sample was rediluted to bring the detector response within linear range,

 $v_d$  = redilution volume (mL),

 $v_a$  = aliquot used for redilution (mL), and

 $d_b$  = dilution factor for the blank cartridge eluate = 1.

11.2 The concentration of carbonyl compound in the original sample is calculated from the following equation:

$$C_A = W_d \times (MW_c/MW_{der}) \times 1000/V_m \text{ (or } V_s) \quad (5)$$

where:

 $C_A$  = concentration (ng/L) of carbonyl compound in the original sample,

 $V_m$  = total air sample volume (L) under the sampling conditions, from 10.1.13,

 $V_s$  = standard air sample volume (L) at 25°C and 101.3 kPa, from 10.1.13,

 $MW_c$  = molecular weight of the carbonyl compound, and

$MW_{der}$  = molecular weight of the DNPH derivative of the carbonyl compound.

The carbonyl compound concentrations can be converted to ppbv using the following equation:

$$C_A (ppbv) = C_{As} (\text{ng/L}) \times 24.4/MW_c \quad (6)$$

where:

- $C_A (ppbv)$  = concentration of carbonyl compound in parts per billion by volume,
- $C_{As}$  = concentration (ng/L) of carbonyl compound in the original sample, calculated using  $V_s$ , and
- 24.4 = ideal gas volume nL/nmole, corrected to 25°C.

## 12. Performance Criteria and Quality Assurance

12.1 This section summarizes required quality assurance measures and provides guidance concerning performance criteria that should be achieved within each laboratory.

### 12.1.1 Standard Operating Procedures (SOPs):

12.1.1.1 Users should generate SOPs describing the following activities in their laboratory: assembly, calibration, and operation of the sampling system, with make and model of equipment used; preparation, purification, storage, and handling of sampling reagent and samples; assembly, calibration, and operation of the HPLC system, with make and model of equipment used; and all aspects of data recording and processing, including lists of computer hardware and software used.

12.1.1.2 The SOPs should provide specific stepwise instructions and should be readily available to and understood by the laboratory personnel conducting the work.

### 12.1.2 HPLC System Performance:

12.1.2.1 The HPLC system efficiency<sup>17</sup> is calculated according to the following equation:

$$n = 5.54 (t_r/W_{1/2})^2 \quad (7)$$

where:

- $n$  = column efficiency (theoretical plates),
- $t_r$  = retention time of analyte, and
- $W_{1/2}$  = width of component peak at half height.

A column efficiency of >5000 theoretical plates should be obtained.

12.1.2.2 Precision or response for replicate HPLC injections should be  $\pm 10\%$  or less, day to day, for analyte calibration standards at  $1\mu\text{g/mL}$  or greater levels. At the  $0.5\text{-}\mu\text{g/mL}$  level and below, precision of replicate analyses could vary up to  $25\%$ . Precision of retention times should be  $\pm 7\%$  on a given day.

12.1.3 *Process Blanks*—At least one field blank or  $10\%$  of the field samples, whichever is larger, should be shipped and analyzed with each group of samples. The number of samples within a group or time frame, or both, should be recorded so that a specified percentage of blanks is obtained for a given number of indoor air samples. The field blank is treated identically as the samples except that no air is drawn through the cartridge. The performance criteria described in 9.1 should be met for process blanks. It is desirable to analyze blank

cartridges retained in the laboratory (laboratory blanks) as well, to distinguish between possible field and laboratory contamination.

12.1.4 Sample loss can occur when the capacity of the sorbent is exceeded, or when the sample volume exceeds the maximum for complete collection. This possibility can be guarded against by employing two sampling cartridges in series, and analyzing the contents of each, or by analyzing both sections of a two-bed sorbent cartridge. Should the quantity of collected analyte in the backup section exceed  $15$  to  $25\%$  of the analyte collected by the primary sampling section, breakthrough may be assumed to have occurred. If it is necessary to report data in cases where breakthrough is suspected, the results should be flagged and reported as equal to or greater than the value obtained from analysis of both cartridges or both sorbent beds.

## 13. Precision and Uncertainty<sup>18</sup>

13.1 The precision and uncertainty of this or any other measurement method for formaldehyde and other carbonyl compounds will be influenced by two parameters: the reproducibility of the method and the variation of the concentration of the analyte in air over time. It is reasonable to assume that the latter (temporal concentration change) will have a much larger effect on precision and uncertainty than the former.

13.2 This test method has been evaluated by round-robin testing using  $55$  to  $105\text{-}\mu\text{m}$  silica gel cartridges coated by the U.S. Environmental Protection Agency and two of its contract laboratories. These cartridges have been used by two different laboratories to make over  $1500$  measurements of formaldehyde and other aldehydes in ambient air for the U.S. Urban Air Toxics Program (UATP), conducted in  $14$  cities throughout the United States.

13.3 The precision of  $45$  replicate HPLC injections of a stock solution of formaldehyde-DNPH derivative over a two-month period has been shown to be  $0.85\%$  relative standard deviation (rsd).

13.4 Triplicate analyses of each of twelve identical samples of exposed DNPH cartridges provided formaldehyde measurements that agreed within  $10.9\%$  rsd.

13.5 A total of  $16$  laboratories in the United States, Canada, and Europe participated in a round-robin test that included  $250$  blank DNPH-cartridges, three sets of  $30$  cartridges spiked at three levels with DNPH derivatives, and  $13$  sets of cartridges exposed to diluted automobile exhaust gas. These cartridges were coated by the U.S. EPA and were of the same type described in 4.1. All round-robin samples were randomly distributed to the participating laboratories. A summary of the round-robin results is shown in Table 3.

NOTE 24—There was no attempt to standardize the HPLC analysis in this round robin. The participants used HPLC procedures as practiced in their laboratories.

13.6 The absolute percent differences between collocated duplicate sample sets from the 1988 UATP program were

<sup>17</sup> See Practice E 682 for definitions of terms used in this section.

<sup>18</sup> Details for the precision and bias studies summarized in this section are on file at ASTM Headquarters.

**TABLE 3 Round-Robin Test Results<sup>A</sup>**

Sample Type	Formaldehyde	Acetaldehyde	Propionaldehyde	Benzaldehyde
Blank cartridges:				
µg aldehyde	0.13	0.18	0.12	0.06
(% rsd)	46	70	47	44
<i>n</i>	33	33	23	8
Spiked <sup>B</sup> cartridges:				
% recovery (% rsd)				
low	89.0 (6.02)	92.6 (13.8)	108.7 (32.6)	114.7 (36.1)
medium	97.2 (3.56)	97.8 (7.98)	100.9 (13.2)	123.5 (10.4)
high	97.5 (2.15)	102.2 (6.93)	100.1 (6.77)	120.0 (8.21)
<i>n</i>	12	13	12	14
Exhaust samples:				
µg aldehyde	5.926	7.990	0.522	0.288
% rsd	12.6	16.54	26.4	19.4
<i>n</i>	31	32	32	17

<sup>A</sup> Sixteen participating laboratories. Statistics shown after removal of outliers.

<sup>B</sup> Normal spiking levels were approximately 0.5, 5, and 10 µg of aldehyde, designated as low, medium, and high in this table.

11.8 % for formaldehyde ( $n = 405$ ), 14.5 % for acetaldehyde ( $n = 386$ ), and 16.7 % for acetone ( $n = 346$ ).

13.7 Collocated duplicate samples collected in the 1989 UATP program and analyzed by a different laboratory showed a mean relative standard deviation of 0.07, correlation coefficient of 0.98, and bias of  $-0.05$  for formaldehyde. Corresponding values for acetaldehyde were 0.12, 0.95, and  $-0.50$ , and for acetone were 0.15, 0.95, and  $-0.54$ .

13.8 In the 1988 UATP program, single-laboratory analyses of spiked DNPH cartridges provided over the year showed an

average bias of  $+6.2\%$  for formaldehyde ( $n = 14$ ) and  $+13.8\%$  for acetaldehyde ( $n = 13$ ).

13.9 Single-laboratory analyses of 30 spiked DNPH cartridges during the 1989 UATP program showed an average bias of  $+1.0\%$  (range from  $-49\%$  to  $+28\%$ ) for formaldehyde and  $+5.1\%$  (range from  $-38\%$  to  $+39\%$ ) for acetaldehyde.

#### 14. Keywords

14.1 active sampler; air; carbonyl compounds; DNPH cartridge; formaldehyde; HPLC analysis

*ASTM International takes no position respecting the validity of any patent rights asserted in connection with any item mentioned in this standard. Users of this standard are expressly advised that determination of the validity of any such patent rights, and the risk of infringement of such rights, are entirely their own responsibility.*

*This standard is subject to revision at any time by the responsible technical committee and must be reviewed every five years and if not revised, either reapproved or withdrawn. Your comments are invited either for revision of this standard or for additional standards and should be addressed to ASTM International Headquarters. Your comments will receive careful consideration at a meeting of the responsible technical committee, which you may attend. If you feel that your comments have not received a fair hearing you should make your views known to the ASTM Committee on Standards, at the address shown below.*

*This standard is copyrighted by ASTM International, 100 Barr Harbor Drive, PO Box C700, West Conshohocken, PA 19428-2959, United States. Individual reprints (single or multiple copies) of this standard may be obtained by contacting ASTM at the above address or at 610-832-9585 (phone), 610-832-9555 (fax), or service@astm.org (e-mail); or through the ASTM website (www.astm.org).*