



Designation: D 4793 – 93 (Reapproved 1999)

Standard Test Method for Sequential Batch Extraction of Waste with Water¹

This standard is issued under the fixed designation D 4793; the number immediately following the designation indicates the year of original adoption or, in the case of revision, the year of last revision. A number in parentheses indicates the year of last approval. A superscript epsilon (ϵ) indicates an editorial change since the last revision or reapproval.

1. Scope

1.1 This test method is a procedure for the sequential leaching of a waste containing at least five % solids to generate solutions to be used to determine the constituents leached under the specified testing conditions.

1.2 This test method calls for the shaking of a known weight of waste with water of a specified purity and the separation of the aqueous phase for analysis. The procedure is conducted ten times in sequence on the same sample of waste and generates ten aqueous solutions.

1.3 This test method is intended to describe the procedure for performing sequential batch extractions only. It does not describe all types of sampling and analytical requirements that may be associated with its application.

1.4 *This standard does not purport to address all of the safety problems, if any, associated with its use. It is the responsibility of the user of this standard to establish appropriate safety and health practices and determine the applicability of regulatory limitations prior to use.*

2. Referenced Documents

2.1 ASTM Standards:

D 75 Practices for Sampling Aggregates²

D 420 Practice for Investigating and Sampling Soil and Rock for Engineering Purposes³

D 653 Terminology Relating to Soil, Rock, and Contained Fluids³

D 1129 Terminology Relating to Water⁴

D 1193 Specification for Reagent Water⁴

D 2216 Test Method for Laboratory Determination of Water (Moisture) Content of Soil, Rock, and Soil-Aggregate Mixtures³

D 2234 Test Method for Collection of a Gross Sample of Coal⁵

D 2777 Practice for Determination of Precision and Bias of Methods of Committee D-19 on Water⁴
D 3370 Practices for Sampling Water⁴

3. Terminology

3.1 Definitions:

3.1.1 For definitions of terms used in this test method, see Terminology D 1129.

3.2 Symbols: Symbols:

3.2.1 Variables listed in this test method are defined in the individual sections where they are discussed. A list of defined variables is also given in Section 11.

3.2.2 Explanation of Variables:

\bar{X}_t = total mean value

\bar{X}_a = analytical mean value (calculated using data from analysis of standards)

S_{tt} = total standard deviation

S_{ta} = analytical standard deviation

S_{te} = estimated standard deviation due to the extraction procedure

S_{ot} = total single operator standard deviation

S_{oa} = analytical single operator standard deviation

S_{oe} = estimated single operator standard deviation due to the extraction procedure

4. Significance and Use

4.1 This test method is intended as a means for obtaining sequential extracts of a waste. The extracts may be used to estimate the release of certain constituents of the waste under the laboratory conditions described in this test method.

4.2 This test method is not intended to provide extracts that are representative of the actual leachate produced from a waste in the field or to produce extracts to be used as the sole basis of engineering design.

4.3 This test method is not intended to simulate site-specific leaching conditions. It has not been demonstrated to simulate actual disposal site leaching conditions.

4.4 An intent of this test method is that the final pH of each of the extracts reflects the interaction of the extractant with the buffering capacity of the waste.

¹ This test method is under the jurisdiction of ASTM Committee D34 on Waste Management and is the direct responsibility of Subcommittee D34.01.04 on Ancillary Topics.

Current edition approved Jan. 15, 1993. Published March 1993. Originally published as D 4793 – 88. Last previous edition D 4793 – 88.

² Annual Book of ASTM Standards, Vol 04.03.

³ Annual Book of ASTM Standards, Vol 04.08.

⁴ Annual Book of ASTM Standards, Vol 11.01.

⁵ Annual Book of ASTM Standards, Vol 05.05.



4.5 An intent of this test method is that the water extractions reflect conditions where the waste is the dominant factor in determining the pH of the extracts.

4.6 This test method produces extracts that are amenable to the determination of both major and minor constituents. When minor constituents are being determined, it is especially important that precautions are taken in sample storage and handling to avoid possible contamination of the samples.

4.7 This test method has been tested to determine its applicability to certain inorganic components in the waste. This test method has not been tested for applicability to organic substances, volatile matter (see Note 3 in 5.15), or biologically active samples.

4.8 The agitation technique, rate, liquid-to-solid ratio, and filtration conditions specified in the procedure may not be suitable for extracting all types of wastes (see Sections 7, 8, and the discussion in Appendix X1).

5. Apparatus

5.1 *Straightedge* (such as a thin-edged yard stick).

5.2 *Impermeable Sheet*, of glazed paper, oil cloth, or other flexible material of a composition suitable to the analytes of interest.

5.3 *Drying Pans or Dishes*—Two per waste (for example, aluminum tins, porcelain dishes, or glass weighing pans), suitable to the waste being tested and the instructions given in 9.2.

5.4 *Drying Oven*—Any thermostatically controlled drying oven capable of maintaining a steady temperature of $\pm 2^\circ\text{C}$ in a range from 100 to 110°C .

5.5 *Desiccator*, having the capacity to hold the drying pans described in 5.3 and the crucibles described in 5.8.

5.6 *Laboratory Balance*, capable of weighing to 0.1 g.

5.7 *Pipet*, 10-mL capacity.

5.8 *Crucibles*—Two per waste, porcelain, 20-mL capacity each.

5.9 *Analytical Balance*, capable of weighing to 0.1 mg.

5.10 *Large Glass Funnel*.

5.11 *Wash Bottle*, 500-mL capacity.

5.12 *pH Meter*—Any pH meter with a readability of 0.01 units and an accuracy of ± 0.05 units at 25°C is acceptable.

5.13 *Agitation Equipment*, of any type that rotates the extraction vessel in an end-over-end fashion at a rate of 30 ± 2 r/min such that the axis of rotation is horizontal and it goes through the center of the bottle, (see Fig. 1 and the discussion of agitation in Appendix X1).

NOTE 1—Similar devices having a different axial arrangement may be used if equivalency can be demonstrated.

5.14 *Pressure Filtration Assembly*—A pressure filtration device of a composition suitable to the nature of the analyses to be performed and equipped with a 0.45 or 0.8- μm pore-size filter (see Note 7, pertaining to 9.4).

5.15 *Extraction Vessels*, cylindrical, wide-mouth, of a composition suitable to the nature of the waste and analyses to be performed, constructed of materials that will not allow sorption of constituents of interest, and sturdy enough to withstand the impact of the falling sample fragments. Container size should be selected so that the sample plus extraction fluid occupy

approximately 95 % of the container. Containers must have water-tight closure. Containers for samples where gases may be released should be provided with a venting mechanism.

NOTE 2—Suitable container sizes range from 4.0 to 4.5 in. (102 to 114 mm) in diameter and 8.5 to 13.0 in. (216 to 330 mm) in height.

NOTE 3—The venting of the container has the potential to affect the concentration of volatile compounds in the extracts.

5.15.1 Extraction vessels should be cleaned in a manner consistent with the analyses to be performed. See Practices D 3370, Section 13.

6. Reagents

6.1 *Purity of Reagents*—Reagent grade chemicals shall be used in all tests. Unless otherwise indicated, it is intended that all reagents shall conform to the specifications of the American Chemical Society, where such specifications are available.⁶ Other grades may be used, provided it is first ascertained that the reagent is of sufficiently high purity to permit its use without lessening the accuracy of the determination.

6.2 *Purity of Water*—Unless otherwise indicated, references to water shall be understood to mean Type IV reagent water at 18 to 27°C (Specification D 1193). The method by which the water is prepared, that is, distillation, ion exchange, reverse osmosis, electro dialysis, or a combination thereof, should remain constant throughout testing.

7. Sampling

7.1 Obtain a representative sample of the waste to be tested using ASTM sampling methods developed for the specific industry where available (see Practices D 75 and D 420, Terminology D 653, and Test Method D 2234).

7.2 Where no specific methods are available, sampling methodology for material of similar physical form shall be used.

7.3 The amount of sample to be sent to the laboratory should be sufficient to perform the solids content determination as specified in 9.2 and to provide 100 g of sample on a dry weight basis for each extraction.

7.4 It is important that the sample of the waste be representative with respect to surface area, as variations in surface area would directly affect the leaching characteristics of the sample. Waste samples should contain a representative distribution of particle sizes.

NOTE 4—Information on obtaining representative samples can also be found in *Pierre Gy's Sampling Theory and Sampling Practice*, Volumes I and II, by F. Picard, CRC Press, 1989.

7.5 In order to prevent sample contamination or constituent loss prior to extraction, keep samples in closed containers appropriate to the sample type and desired analysis. See Practices D 3370 for guidance. Record the storage conditions and handling procedures in the report.

⁶ "Reagent Chemicals, American Chemical Society Specifications," Am. Chemical Soc., Washington, DC. For suggestions on the testing of reagents not listed by the American Chemical Society, see "Reagent Chemicals and Standards," by Joseph Rosin, D. Van Nostrand Co., Inc., New York, NY, and the "United States Pharmacopeia."

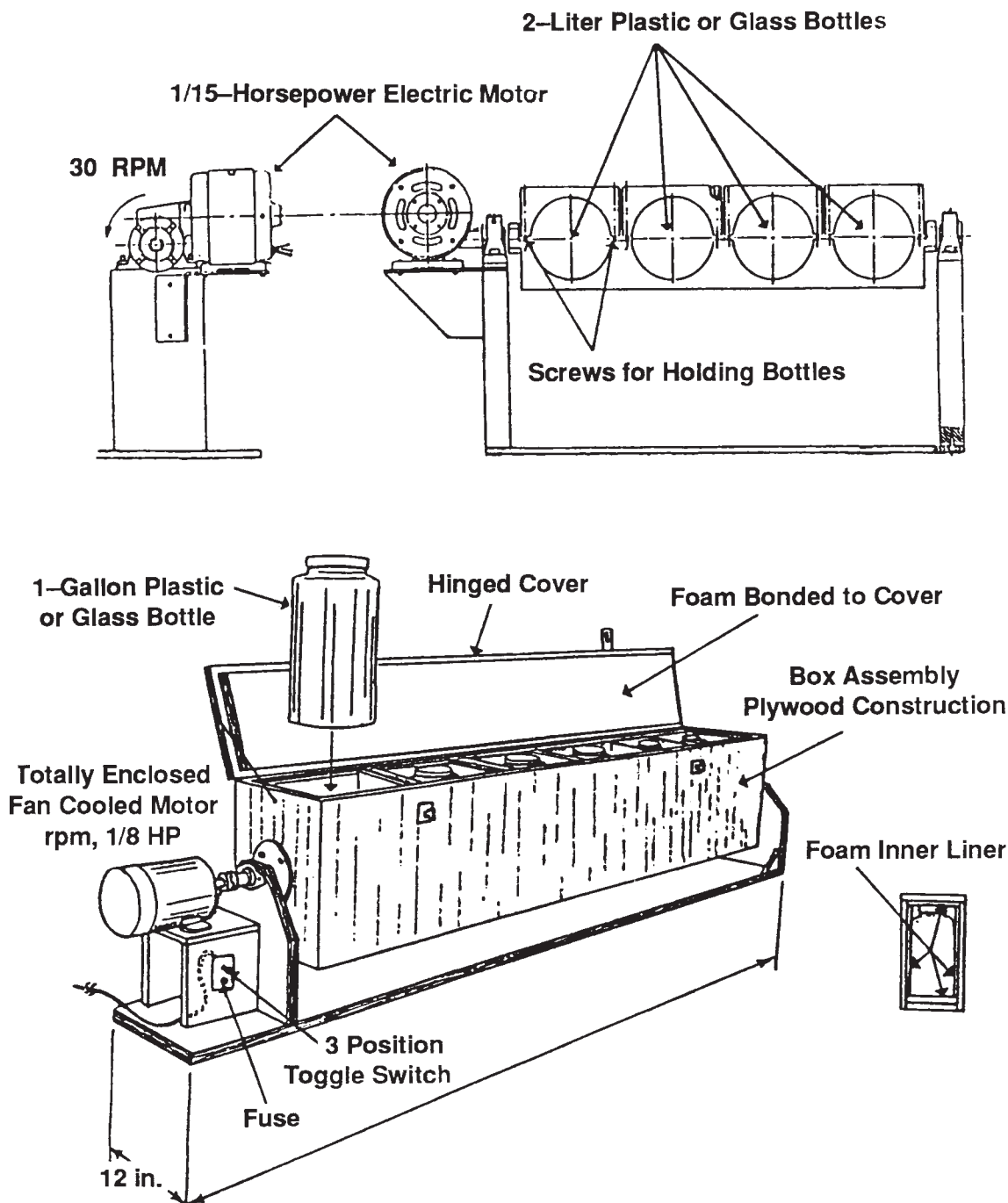

FIG. 1 Extractors

7.6 The time between collection and extraction of the sample should be determined by the nature of the sample and the information desired. See Practices D 3370 for guidance. Report the length of time between sample collection and extraction.

8. Sample Preparation

8.1 For free-flowing particulate solid wastes, obtain a sample of the approximate size required in the test by quartering the sample (Section 7) received for testing on an impermeable sheet of glazed paper, oil cloth, or other flexible material as follows:

8.1.1 Empty the sample container into the center of the sheet.

8.1.2 Flatten out the sample gently with a suitable straight-edge until it is spread uniformly to a depth at least twice the maximum particle diameter.

8.1.3 Remix the sample by lifting a corner of the sheet and drawing it across, low down, to the opposite corner in a manner that the material is made to roll over and over and does not merely slide along. Continue the operation with each corner, proceeding in a clockwise direction. Repeat this operation ten times.

8.1.4 Lift all four corners of the sheet towards the center and, holding all four corners together, raise the entire sheet into the air to form a pocket for the sample.

8.1.5 Repeat 8.1.2.

8.1.6 With a straightedge (such as a thin-edged yard stick), one at least as long as the flattened mound of sample, gently divide the sample into quarters. Make an effort to avoid using pressure on the straightedge sufficient to cause damage to the particles.

8.1.7 Discard alternate quarters.

8.1.8 If further reduction of sample size is necessary, repeat 8.1.3-8.1.7. Use a sample size to give 100 g of solid for each extraction. Provide additional samples for determination of solids content. If smaller samples are used in the test, report this fact.

NOTE 5—For other acceptable methods for mixing and subsampling free-flowing solid particulate wastes, see *Pierre Gy's Sampling Theory and Sampling Practice*, Volumes I and II, by F. Picard, CRC Press, 1989. The method of subsampling should be determined by the physical properties of the waste, analytes of interest, and equipment available.

8.2 For field-cored solid wastes or castings produced in the laboratory, cut a representative section weighing approximately 100 g for testing plus samples for determination for solids content. Shape the sample so that the leaching solution will cover the material to be leached.

8.3 For multiphasic wastes, mix thoroughly to ensure that a representative sample will be withdrawn. Take samples for determination of solids content at the same time as the test samples.

9. Procedure

9.1 Record the physical description of the sample to be tested, including particle size so far as it is known.

9.2 *Solids Content*—Determine the solids content of two separate portions of the sample as follows:

9.2.1 Dry to a constant weight at $104 \pm 2^\circ\text{C}$ two dishes or pans of size suitable to the solid waste being tested. Cool in a desiccator and weigh. Record the values to ± 0.1 g.

9.2.2 Put an appropriately sized portion of sample of the waste to be tested into each pan. Scale the weight used to the physical form of the waste tested. Use a minimum of 50 g, but use larger samples where particles larger than 10 mm in average diameter are being tested (see Test Method D 2216).

9.2.3 Dry 16 to 20 h at $104 \pm 2^\circ\text{C}$. Record the temperature and time of the drying period.

9.2.4 Cool to room temperature in a desiccator and reweigh. Record the mass to ± 0.1 g.

9.2.5 Repeat steps 9.2.3 and 9.2.4 until constant container-sample masses are obtained. Discard the dried samples following completion of this step.

9.2.6 Calculate the solids content of the sample from the data obtained in 9.2.2 and 9.2.4 as follows:

$$S = A/B \quad (1)$$

where:

A = mass of sample after drying, g,

B = original mass of sample, g, and

S = solids content, g/g.

Average the two values obtained. Record the solids content.

9.3 *Extraction Procedure*—If the entire procedure cannot be conducted without interruption, at least the first four extraction sequences must be conducted without interruption.

9.3.1 Determine the mass of the extraction vessel to be used in the extraction procedure to the nearest 0.1 g. Record the mass of the extraction vessel, $M_{v,1}$. Use one extraction vessel per waste throughout the sequence of extractions.

9.3.2 Add 100 g (weighed to ± 0.1 g) of solid waste on a dry weight basis to the extraction vessel. Calculate the amount of waste as received to add using the following equation:

$$M = \frac{100}{S} \quad (2)$$

where:

M = mass of waste as received to add to the extraction vessel to give 100 g (weighed to ± 0.1 g) of solid waste.

9.3.2.1 If a mass of solid waste on a dry weight basis other than 100 g is used, (Eq 2) through (4) must be modified to reflect the use of a mass other than 100 g. Replace 100 in these equations with the mass used. Use of a mass other than 100 g is not recommended.

9.3.3 Add a volume in millilitres, $V_{v,2}$, of test water (see 6.2) to the extraction vessel determined using the following equations:

$$M_{sw} = M - 100 \quad (3)$$

where:

M_{sw} = mass of moisture in the sample added to the extraction vessel, g.

$$V_{v,2} = (20)(100) - M_{sw} \quad (4)$$

9.3.4 Agitate continuously for 18 ± 0.25 h at 18 to 27°C . Record the agitation time and temperature.

9.3.5 Open the extraction vessel. Observe and record any visible physical changes in the sample and leaching solution. Record the pH of the waste/leaching solution slurry.

9.4 *Filtration*—Transfer as much of the waste/leaching solution as possible through a large glass funnel to a pressure filtration device equipped with a 0.45 or 0.8- μm filter. Transfer the mixed slurry. Do not decant. Invert the extraction vessel over the filtration device and allow the liquid to drain from the solid remaining in the extraction vessel for 1 min. It is important to achieve as complete a transfer of fluid from the extraction vessel to the filtration device as possible. Pressure filter the liquid through the filter using nitrogen gas. After the extract has passed through the filter, continue running nitrogen gas through the filtration device at 30 psi for 3 min. The filtrate obtained is the extract mentioned in this test method (see 9.5, 10.8, and 10.9). Determine the volume of the filtrate collected and report it as V for that extraction step. Measure the pH of the extract immediately, remove the volume of filtrate necessary for determination of total dissolved solids content in 9.5, and then preserve the extract in a manner consistent with the

chemical analyses or biological testing procedures to be performed (Practices D 3370, Section 15).

NOTE 6—It is recommended that all filtrations be performed in a hood.

NOTE 7—Analytical results may be affected by the type of filter used. If a 0.8- μm filter pore size is used, the resulting extract should be digested prior to elemental analysis. If the filter is composed of material that may contaminate the extract during filtration, the filter should be washed in the filtration device in a manner consistent with the chemical analyses or biological testing procedures to be performed on the extract. For example, for elemental analysis of the extract, if a filter composed of borosilicate glass fiber is used, it should be washed in the filtration device with a dilute acid solution and rinsed with approximately 2 L of water prior to filtration to prevent contamination.

NOTE 8—Prefilters can be used only if it is absolutely necessary (if the filtrate for analysis or testing cannot be obtained unless a prefilter is used) due to loss of sample trapped in the pores of the prefilter and the possibility of the prefilter disintegrating during rinsing.

9.5 Total Dissolved Solids Content (TDS)—Transfer a 10.0-mL sample of the extract to each of two preweighed crucibles (weighed to ± 0.1 mg), previously dried at $110 \pm 2^\circ\text{C}$. Place the samples in a drying oven at $110 \pm 2^\circ\text{C}$ for 3 h. Record the drying oven temperature and drying time. Remove the crucibles and let cool in a desiccator. Reweigh the crucibles and record their weights to ± 0.1 mg.

NOTE 9—Only one drying is performed to limit the contact time between the solid and the rinse water in the extraction vessel prior to the next extraction step (see 9.6 and Section 10).

9.6 Quantitatively transfer the damp solid from the filter back to the original extraction vessel, including the filter. Use water (see 6.2) from a pre-weighed wash bottle to assist in this transfer and to rinse the filtration device. No more than 500 mL of water should be used for rinsing. Use the smallest volume of wash water possible to achieve a thorough transfer. Using tweezers or a similar device, recover the filter and rinse the adhering solid into the extraction vessel with water from the pre-weighed wash bottle. Do not leave the filter in the extraction vessel. Reweigh the wash bottle to determine the amount of water used in the transfer. Record this value as M_w . Weigh the extraction vessel following the transfer described above and record this value as M_v . The extraction vessel may be sealed until a feasible time for addition of new extraction fluid. This is to enable filtration during the next sequence at a reasonable time during the day. If the slurry is stored for longer than 6 h in the extraction vessel prior to the addition of new extraction fluid, the data generated by the analysis of the extracts should be plotted to check for perturbation of the data curve.

10. Calculation

10.1 Calculate the total dissolved solids contents, TDS, in milligrams per litre of the filtrate using the following equation:

$$TDS = (M_{sc} - M_c)(100) \quad (5)$$

where:

M_{sc} = mass of the crucible and dried solids, mg, and

M_c = mass of the crucible, mg.

10.2 Calculate the mass of the solid in grams lost through dissolution, M_d , using the following equation:

$$M_d = (TDS)(V)(0.001) \quad (6)$$

where:

V = volume of filtrate collected in that extraction, L, and

M_d = mass loss through dissolution.

10.3 Calculate the mass of the solid corrected for TDS remaining for the next extraction step, M_s , using the following equation:

$$M_s = M_s^{e-1} - M_d \quad (7)$$

where:

M_s^{e-1} = mass of the solid extracted in the current extraction step, g.

NOTE 10—For example, in beginning the first extraction, M_s^{e-1} will equal 100 g, and to calculate the mass of solid remaining for the second extraction step, M_s will equal $100 \text{ g} - M_d$.

10.4 Calculate the combined mass of the solid and the residual liquid in the extraction vessel, M_{sl} , using the following equation:

$$M_{sl} = M_v - M_{v1} - M_w \quad (8)$$

10.5 Calculate the mass of liquid adhering to the solids in the extraction vessel, M_l , using the following equation:

$$M_l = M_{sl} - M_s \quad (9)$$

10.6 Calculate the volume in millilitres of new test water to be added to the extraction vessel, Test Water Volume, TWV, using the following equation:

$$TWV = [(M_s)(20)] - M_l - M_w \quad (10)$$

10.7 Add to the extraction vessel the amount of new test water, TWV, determined in 10.6, and repeat 9.3.4 through 10.7 so that ten extractions are done in sequence.

NOTE 11—This procedure assumes that the amount of waste that is trapped in the filters after rinsing is negligible.

10.8 Analyze the extracts for specific constituents or properties or use the extracts for biological testing procedures as desired using appropriate ASTM test methods. Where no appropriate ASTM test methods exist, other methods may be used and recorded in the report. Where phase separation occurs during the storage of the extracts, appropriate mixing should be used to ensure the homogeneity of the extracts prior to their use in such analyses or testing.

10.9 Compensation for Carry-Over—For each constituent in each of the extracts generated in the extraction sequence, the contribution to concentration from the residual liquid from the previous extraction step, C_j , can be calculated using the following equation:

$$C_j = [M_{l1}/20(M_s^{e-1})][C_i] \quad (11)$$

where:

C_i = concentration of the constituent in the filtrate from the previous extraction step,



M_{li} = M_1 from the previous extraction step, and
 M_s^{e-1} = mass of solid extracted in the current extraction step (see Note 10).

11. Definition of Variables

11.1 The following variables must be determined when performing the sequential batch extraction procedure:

11.1.1 Solids Content Determination:

A = mass of the sample after drying in the determination of the solids content of the waste to be extracted, g,
 B = original mass of the sample prior to drying in the determination of the solids content of the waste to be extracted, g, and
 S = solids content of the waste to be extracted, g/g.

11.1.2 First Extraction Step:

M = mass of waste as received added to the extraction vessel to give 100 g (weighted to ± 0.1 g) of solid on a dry weight basis for the first extraction step, g,
 V_{vl} = volume of test water to be added for the first step in the extraction procedure, mL, and
 M_{sw} = mass of the moisture in the sample to be extracted in the first extraction step, g.

11.1.3 TDS Determination:

TDS = total dissolved solids content of the filtrate, mg/L,
 M_c = mass of the crucible to be used in the TDS determination, mg, and
 M_{sc} = mass of the crucible and dried solids in the TDS determination, mg.

11.1.4 Extraction Sequence:

M_d = mass of the solid lost through dissolution during extraction, g,
 V = volume of filtrate collected in that extraction, L,
 M_s = mass of the solid remaining for the next extraction step, g,
 M_s^{e-1} = mass of the solid extracted in the current extraction step, g,
 $M_{v,l}$ = mass of the empty extraction vessel, g,
 M_w = mass of the rinse water, g,
 M_v = combined mass of the extraction vessel, rinse water, solid and moisture in the solid, and solid and liquid left in the extraction vessel after transfer to the filtering device, g,
 M_{sl} = combined mass of the solid and the residual liquid in the extraction vessel following transfer of the moist sample cake back to the extraction vessel, g,
 M_l = mass of the liquid adhering to the solids in the extraction vessel following transfer of the moist sample cake back to the extraction vessel, g, and
 TWV = volume of test water to be added for the next extraction step, mL.

11.1.5 Compensation for Carry-Over:

C_j = contribution to a constituent's concentration in the current step from the residual liquid of the previous extraction step, mg/L,
 M_{li} = M_l from the previous extraction step, g,
 M_s^{e-1} = mass of solid extracted in the current step, g, and
 C_i = concentration of the constituent in the filtrate from the previous extraction step, mg/L.

12. Report

12.1 Report the following information:

12.1.1 Source of the waste, date of sampling, method of sampling, method of sample preservation, storage conditions, handling procedures, and length of time between sample collection and extraction,

12.1.2 Description of the waste, including physical characteristics and particle size, if known (9.1),

12.1.3 Solids content (9.2) (see Test Method D 2216),

12.1.4 Mass of solid waste extracted if other than 100 g (8.1.8),

12.1.5 Time and temperature used in the determination of solids content and TDS,

12.1.6 Agitation temperature and time,

12.1.7 Filter pore size used and filter composition; use of a prefilter and prefilter pore size and composition,

12.1.8 Observations of changes in test material or leaching solutions (9.3.5),

12.1.9 Storage of the solid with rinse water in the extraction vessel for any period longer than 6 h,

12.1.10 pH before and after filtration and results of specific analyses calculated in appropriate units and corrected for carry-over if necessary, and

12.1.11 Dates sequential batch extraction started and completed, preservation used for extracts, and date of analyses.

NOTE 12—Fig. 2 presents a report format for recording some of the experimental data.

13. Precision and Bias⁷

13.1 Precision:

13.1.1 A collaborative study of this test method involving eight laboratories was conducted. Each laboratory extracted a single sample in duplicate. The extracts generated in the first, third, fifth, seventh, and tenth extraction steps were analyzed by each participant and by a reference laboratory. In addition, three standards containing high, medium, and low concentrations of the elements of interest, aluminum, calcium, copper, iron, magnesium, nickel, and zinc were analyzed by each participant in triplicate in order to determine the analytical precision. From the data generated, precision calculations were performed using Practice D 2777 as a guideline.

13.1.2 Three types of precision can be determined from the data generated. These are the total standard deviation, S_{tt} , the analytical standard deviation, S_{ta} , and the estimated standard deviation of the extraction procedure, S_{te} . The standard deviations calculated using the data generated by the individual

⁷ Supporting data for the precision statement and concerning analytical bias have been filed at ASTM Headquarters and may be obtained by requesting RR: D34-1005.



Sample Number: _____

In Generating Extract Number	TDS (mg/L)	V (L)	M_d (g)	M_s (g)	M_v (g)	M_{y1} (g)	M_w (g)	M_{s1} (g)	M_j (g)	TWV (mL)
1										
2										
3										
4										
5										
6										
7										
8										
9										
10										

FIG. 2 Sequential Batch Procedure Data Sheet

laboratories from their analyses of the extracts are due to a combination of both the extraction procedure and the analytical errors (S_H). The precision data determined from the analyses of the high, medium, and low standards represent those values due to analytical error only (S_{ta}), and the standard deviation of the extraction procedure represents the estimated error due only to the extraction method (S_{te}). The estimated standard deviation of the extraction procedure for each element of interest in Extracts 1, 3, 5, 7, and 10 was calculated using the following equation:

$$S_{te} = (S_H^2 - S_{ta}^2)^{1/2} \quad (12)$$

These values, along with the total and analytical mean values (\bar{X}_t and \bar{X}_a) and standard deviations, are listed in Table 1.

13.1.3 The three types of precision values discussed in 13.1.2, total, analytical, and extraction procedure, can also be calculated based on a single operator. Calculations were performed to determine the total single operator precision, S_{ot} , the single operator analytical standard deviation, S_{oa} , and the single operator estimated standard deviation of the extraction procedure, S_{oe} . The single operator estimated standard deviation of the extraction procedure was calculated using the following equation:

$$S_{oe} = (S_{ot}^2 - S_{oa}^2)^{1/2} \quad (13)$$

The single operator precision values are listed in Table 2.

13.1.4 Calculation of the standard deviation of the extraction procedure can provide only an approximation due to the limited high-, medium-, and low-concentration values of the analytical standards. To calculate the precision of the extraction

**TABLE 1 Sequential Batch Extraction Round-Robin Study
Statistical Data Summarized—Estimated Total Precision
of the Extraction Procedure (µg/g)**

Extract	Aluminum	Calcium	Copper	Iron	Magnesium	Nickel	Zinc
Extract 1							
\bar{X}_t	75.4	982.0	12.3	68.2	189.0	63.3	237.0
S_{tt}	10.1	286.0	2.69	9.49	19.6	6.52	25.3
\bar{X}_a	54.2	1072.0	2.25	55.2	190.0	55.3	186.0
S_{ta}	5.03	326.0	0.260	4.24	16.4	4.56	20.1
S_{te}	8.75	... ^A	2.65	8.49	10.7	4.66	15.4
Extract 3							
\bar{X}_t	10.5	72.1	0.990	1.87	7.78	2.74	11.3
S_{tt}	9.20	30.6	1.06	0.404	2.32	1.05	5.24
\bar{X}_a	2.50	19.9	2.25	2.70	2.33	2.22	2.28
S_{ta}	0.765	1.67	0.260	0.450	0.327	0.331	0.183
S_{te}	9.17	30.6	0.950	... ^A	2.30	0.996	5.24
Extract 5							
\bar{X}_t	6.23	52.8	0.322	1.85	4.73	2.01	8.46
S_{tt}	2.17	12.4	0.100	0.516	1.09	0.470	2.38
\bar{X}_a	2.50	19.9	2.25	2.70	2.33	2.22	2.28
S_{ta}	0.765	1.67	0.260	0.450	0.327	0.331	0.183
S_{te}	2.03	12.3	... ^A	0.252	1.04	0.333	2.37
Extract 7							
\bar{X}_t	5.13	52.7	0.416	1.53	3.95	1.59	6.65
S_{tt}	1.90	4.86	0.089	0.730	1.47	0.270	0.652
\bar{X}_a	2.50	19.9	2.25	2.70	2.33	2.22	2.28
S_{ta}	0.765	1.67	0.260	0.450	0.327	0.331	0.183
S_{te}	1.74	4.56	... ^A	0.455	1.43	... ^A	0.626
Extract 10							
\bar{X}_t	1.46	62.3	0.444	1.56	2.72	1.36	6.71
S_{tt}	0.866	21.7	0.067	0.467	0.679	0.239	1.89
\bar{X}_a	2.50	19.9	2.25	2.70	2.33	2.22	2.28
S_{ta}	0.765	1.67	0.260	0.450	0.327	0.331	0.183
S_{te}	0.406	21.6	... ^A	0.125	0.556	... ^A	1.88

^ASee 13.1.4.

procedure for a particular element, the analytical standard

**TABLE 2 Sequential Batch Extraction Round-Robin Study
Statistical Data Summarized—Estimated Single Operator
Precision of the Extraction Procedure (µg/g)**

Extract 1	Alumi- num	Cal- cium	Cop- per	Iron	Mag- nesium	Nickel	Zinc
\bar{X}_t	75.4	982.0	12.3	68.2	189.0	63.3	237.0
S_{ot}	2.31	28.0	0.687	0.877	7.90	2.03	7.19
\bar{X}_a	54.2	1072.0	2.25	55.2	190.0	55.3	186.0
S_{oa}	1.82	26.2	0.260	1.83	5.05	2.30	3.84
S_{oe}	1.42	9.88	0.636	... ^A	6.07	... ^A	6.08
Extract 3							
\bar{X}_t	10.5	72.1	0.990	1.87	7.78	2.74	11.3
S_{ot}	0.678	5.26	0.080	0.437	1.07	0.094	0.622
\bar{X}_a	2.50	19.9	2.25	2.70	2.33	2.22	2.28
S_{oa}	0.098	0.666	0.260	0.450	0.288	0.110	0.097
S_{oe}	0.671	5.22	... ^A	... ^A	1.03	... ^A	0.614
Extract 5							
\bar{X}_t	6.23	52.8	0.322	1.85	4.73	2.01	8.46
S_{ot}	1.46	12.7	0.000	0.266	0.987	0.160	0.810
\bar{X}_a	2.50	19.9	2.25	2.70	2.33	2.22	2.28
S_{oa}	0.098	0.666	0.260	0.450	0.288	0.110	0.097
S_{oe}	1.46	12.7	... ^A	... ^A	0.944	0.116	0.804
Extract 7							
\bar{X}_t	5.13	52.7	0.416	1.53	3.95	1.59	6.65
S_{ot}	0.865	2.17	0.100	0.255	0.385	0.319	0.535
\bar{X}_a	2.50	19.9	2.25	2.70	2.33	2.22	2.28
S_{oa}	0.098	0.666	0.260	0.450	0.288	0.110	0.097
S_{oe}	0.859	2.06	... ^A	... ^A	0.255	0.299	0.526
Extract 10							
\bar{X}_t	1.46	62.3	0.444	1.56	2.72	1.36	6.71
S_{ot}	0.955	8.40	0.032	0.308	0.188	0.235	0.968
\bar{X}_a	2.50	19.9	2.25	2.70	2.33	2.22	2.28
S_{oa}	0.098	0.666	0.260	0.450	0.288	0.110	0.097
S_{oe}	0.950	8.37	... ^A	... ^A	... ^A	0.208	0.963

^ASee 13.1.4.

deviation for analysis of the analytical standard containing the concentration of the element closest to its concentration in the extract was used. For some of the extracts, the elemental concentration varies significantly from the element's closest concentration among the analytical standards. Also in some cases, the analytical standard deviation values, S_{ia} and S_{oa} in Table 1 and Table 2, are larger than the total standard deviation value, S_{it} and S_{ot} . In those particular cases, the standard deviation of the extraction procedure cannot be determined.

13.1.5 The estimated precision of this sequential batch extraction procedure varies with the concentration of each of the seven constituents of interest in the collaborative study according to Figs. 3-9. These are plots of the calculated percent relative standard deviation of the extraction procedure versus the total mean concentration of the constituent (data listed in Table 1).

13.1.6 For the concentration values determined in the third, fifth, seventh, and tenth extracts, there does not appear to be a relationship between elemental concentration and estimated precision of the extraction procedure. Because of the very limited data at higher concentrations, it cannot be determined if such a trend exists at higher concentration levels; however, the estimated precision of the extraction procedure is generally best for the elemental concentration values determined in the first extract.

13.1.7 These collaborative test data were obtained through the extraction of a raw oil shale sample. Nitrocellulose filters having a pore size of 0.45 µm were used by each of the

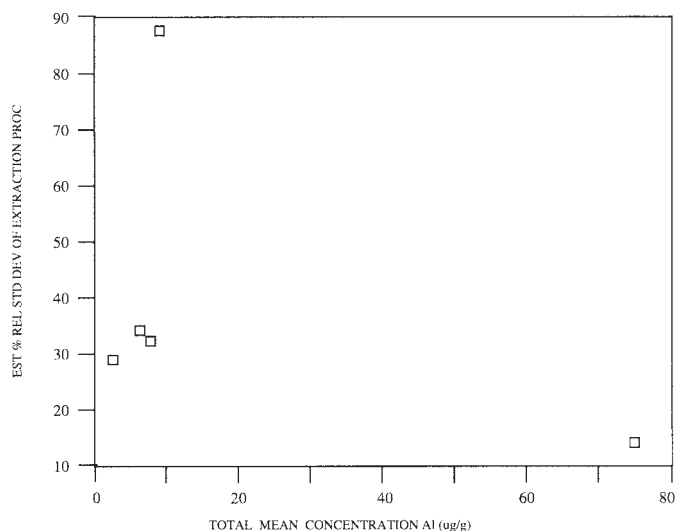

FIG. 3 Estimated Precision of Extraction Procedure—Aluminum

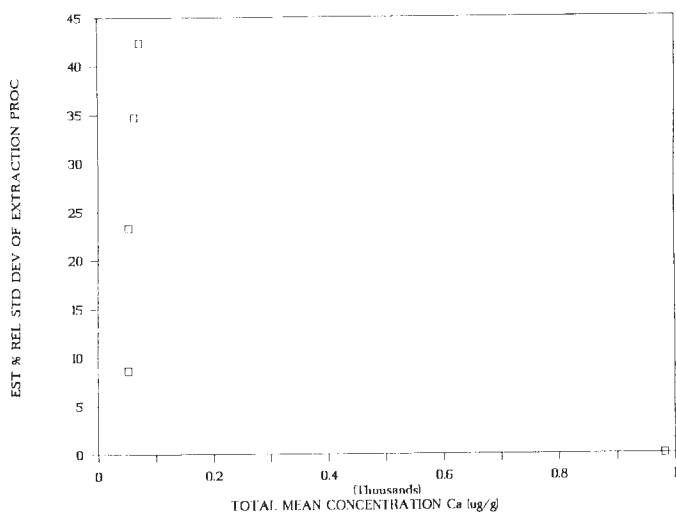

FIG. 4 Estimated Precision of Extraction Procedure—Calcium

collaborative study laboratories for the filtering specified in 9.4. For other test materials and filter types, these data may not apply.

13.1.8 The estimated precision of the extraction procedure includes the increase in variability that may be attributable to field collection, laboratory crushing and sample splitting, and distribution of split samples to the various laboratories for testing. The analytical precision was calculated using data determined for the standard solutions, and as a result, it does not include variability due to various liquid matrices.

13.2 *Bias*—Determination of the bias of this test method is not possible, as no standard reference material exists. Information concerning the analytical bias determined from the collaborative study of this procedure is available in RR: D34-1005.

14. Keywords

14.1 extract; extraction fluid; leaching; sequential batch extraction; waste leaching technique

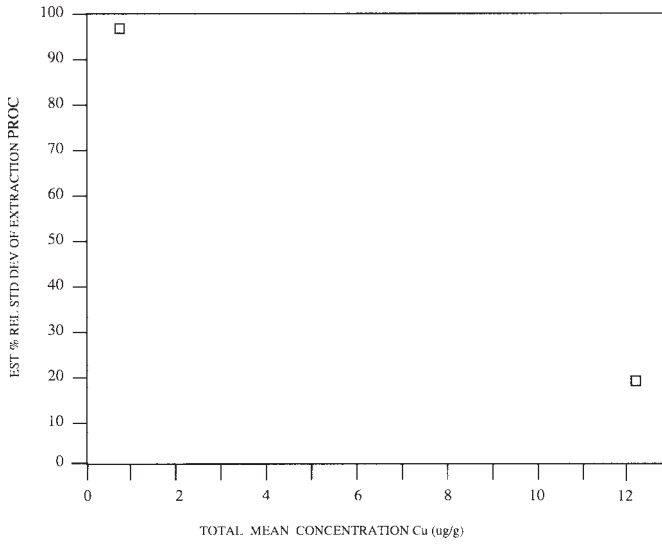

FIG. 5 Estimated Precision of Extraction Procedure—Copper

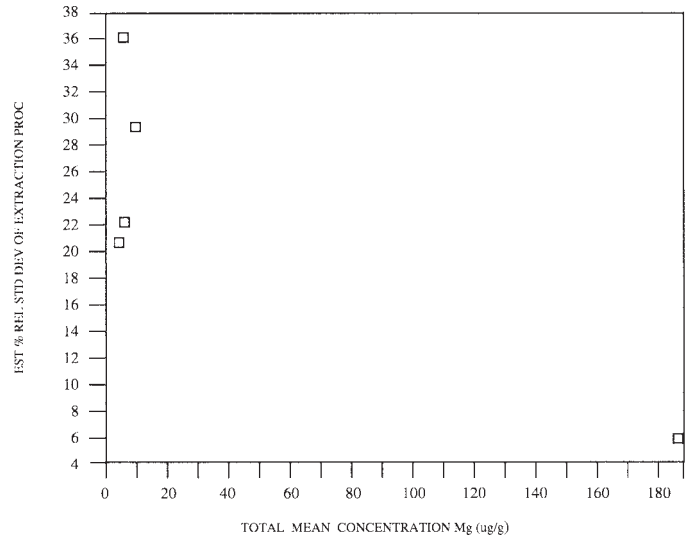

FIG. 7 Estimated Precision of Extraction Procedure—Magnesium

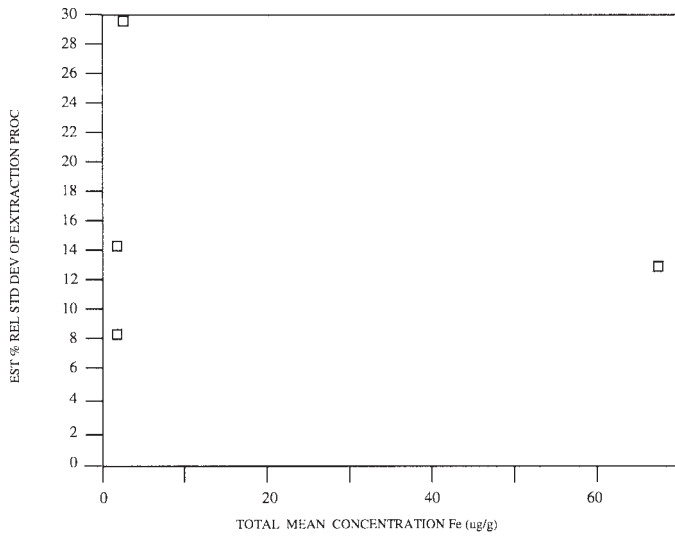

FIG. 6 Estimated Precision of Extraction Procedure—Iron

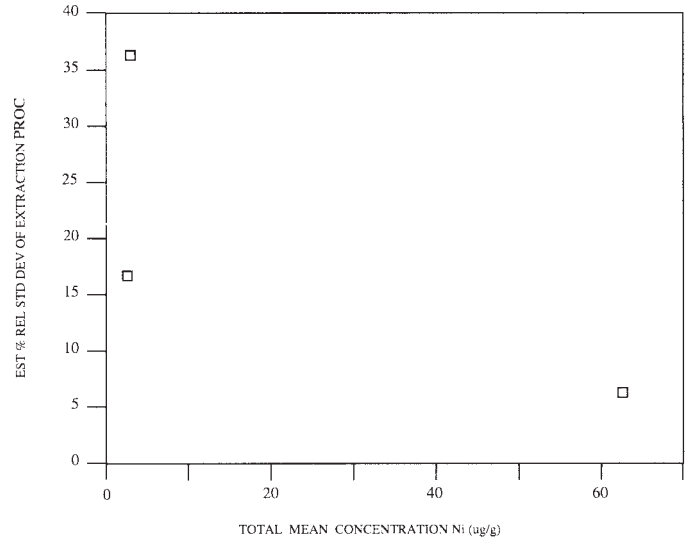

FIG. 8 Estimated Precision of Extraction Procedure—Nickel

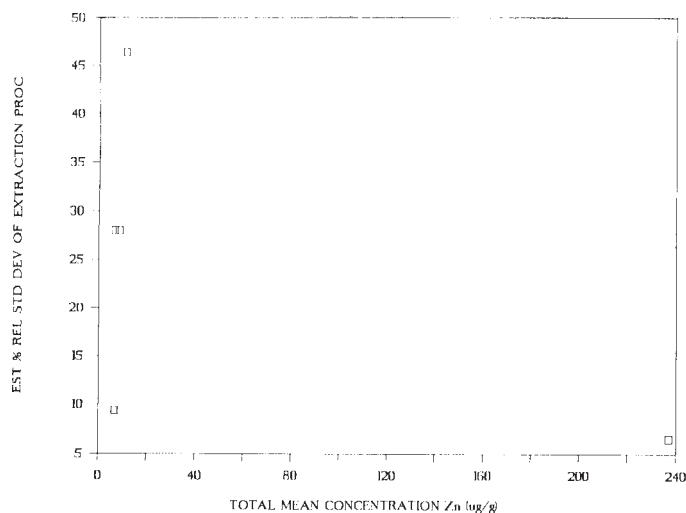

FIG. 9 Estimated Precision of Extraction Procedure—Zinc

APPENDIX

(Nonmandatory Information)

X1. AGITATION TECHNIQUES AND RATE AND LIQUID/SOLID RATIO

X1.1 The agitation rate, equipment, and liquid/solid ratio specified in this test method may significantly influence the results on certain solid wastes, and may not be adequate for certain solid wastes, such as monolithic, solidified, or organic wastes.

X1.2 The possible effects of varying the agitation technique and rate include degree of mixing, rate of release of constitu-

ents, and particle abrasion effects. The precision of this test method may also be influenced.

X1.3 The possible effects of varying the liquid/solid ratio include degree of mixing, rate of release of constituents (and possible concentration effects, depending on availability), and particle abrasion effects.

The American Society for Testing and Materials takes no position respecting the validity of any patent rights asserted in connection with any item mentioned in this standard. Users of this standard are expressly advised that determination of the validity of any such patent rights, and the risk of infringement of such rights, are entirely their own responsibility.

This standard is subject to revision at any time by the responsible technical committee and must be reviewed every five years and if not revised, either reapproved or withdrawn. Your comments are invited either for revision of this standard or for additional standards and should be addressed to ASTM Headquarters. Your comments will receive careful consideration at a meeting of the responsible technical committee, which you may attend. If you feel that your comments have not received a fair hearing you should make your views known to the ASTM Committee on Standards, at the address shown below.

This standard is copyrighted by ASTM, 100 Barr Harbor Drive, PO Box C700, West Conshohocken, PA 19428-2959, United States. Individual reprints (single or multiple copies) of this standard may be obtained by contacting ASTM at the above address or at 610-832-9585 (phone), 610-832-9555 (fax), or service@astm.org (e-mail); or through the ASTM website (www.astm.org).