



Standard Practice for Performance Evaluation of In-Plant Walk-Through Metal Detectors¹

This standard is issued under the fixed designation C 1309; the number immediately following the designation indicates the year of original adoption or, in the case of revision, the year of last revision. A number in parentheses indicates the year of last reapproval. A superscript epsilon (ϵ) indicates an editorial change since the last revision or reapproval.

INTRODUCTION

Nuclear regulatory authorities require personnel entering designated security areas to be screened for concealed weapons and personnel exiting areas containing specified quantities of special nuclear material to be screened for metallic nuclear shielding materials. Portal-type walk-through metal detectors are widely used to implement these requirements. This practice provides guidelines for evaluating the in-plant performance of walk-through metal detectors.

1. Scope

1.1 This practice is one of several (see Appendix X1) developed to assist operators of nuclear facilities with meeting the metal detection performance requirements set by regulatory authorities.

1.2 This practice consists of four procedures useful for evaluating the in-plant performance of walk-through metal detectors (see Fig. 1).

1.2.1 Two of the procedures provide data for evaluating probability of detection. These procedures use binomial data (alarm/not alarm).

1.2.1.1 The detection sensitivity test (DST)² is the initial procedure in the detection probability evaluation series. It is used to establish the probability of detection immediately after the detector has been adjusted to its operational sensitivity setting.

1.2.1.2 The detection sensitivity verification test (DSVT)² procedure periodically provides data for evaluation of continuing detection performance.

1.2.2 The third procedure is a “functional test.” It is used routinely to verify that a metal detector is operating and responds with the correct audio and visual signals when subjected to a condition that should cause an alarm.

1.2.3 The fourth procedure is used to verify that alarms generated during detection sensitivity testing were likely the result of the detection of metal and not caused by outside

interferences or the perturbation of the detection field by the tester’s body mass.

1.2.3.1 This procedure also can be used to establish a probability of occurrence for false alarms, for example, 20 test passes by a clean-tester resulting in no alarms indicates a false alarm probability of less than 0.15 at 95 % confidence. This procedure is optional unless required by the regulatory authority.

1.3 This practice does not set test object specifications. The specifications should be issued by the regulatory authority.

1.4 This practice is intended neither to set performance levels nor to limit or constrain technologies.

1.5 This practice does not address safety or operational issues associated with the use of walk-through metal detectors.

2. Referenced Documents

2.1 ASTM Standards:

C 1238 Guide for Installation of Walk-Through Metal Detectors³

C 1269 Practice for Adjusting the Operational Sensitivity Setting of In-Plant Walk-Through Metal Detectors³

C 1270 Practice for Detection Sensitivity Mapping of In-Plant Walk-Through Metal Detectors³

F 1468 Practice for Evaluation of Metallic Weapons Detectors for Controlled Access Search and Screening⁴

3. Terminology

3.1 Definitions of Terms Specific to This Standard:

3.1.1 *clean-tester, n*—a person who does not carry any extraneous metallic objects that would significantly alter the signal produced when the person carries a test object.

3.1.1.1 *Discussion*—By example but not limitation, such extraneous metallic objects may include: metallic belt buckles,

¹ This practice is under the jurisdiction of ASTM Committee C-26 on Nuclear Fuel Cycle and is the direct responsibility of Subcommittee C26.12 on Safeguard Applications.

Current edition approved Dec. 10, 1997. Published February 1998. Originally published as C 1309 – 95. Last previous edition C 1309 – 95.

² The DST is one of two procedures used to evaluate detection rate. The Detection Sensitivity Verification Test (DSVT) is the other. In the evaluation test strategy, the DST is used to initially determine and document the detection rate and then the DSVT is used to periodically check that the detection rate continues to meet the requirements.

³ *Annual Book of ASTM Standards*, Vol 12.01.

⁴ *Annual Book of ASTM Standards*, Vol 15.07.

ASTM C 1309

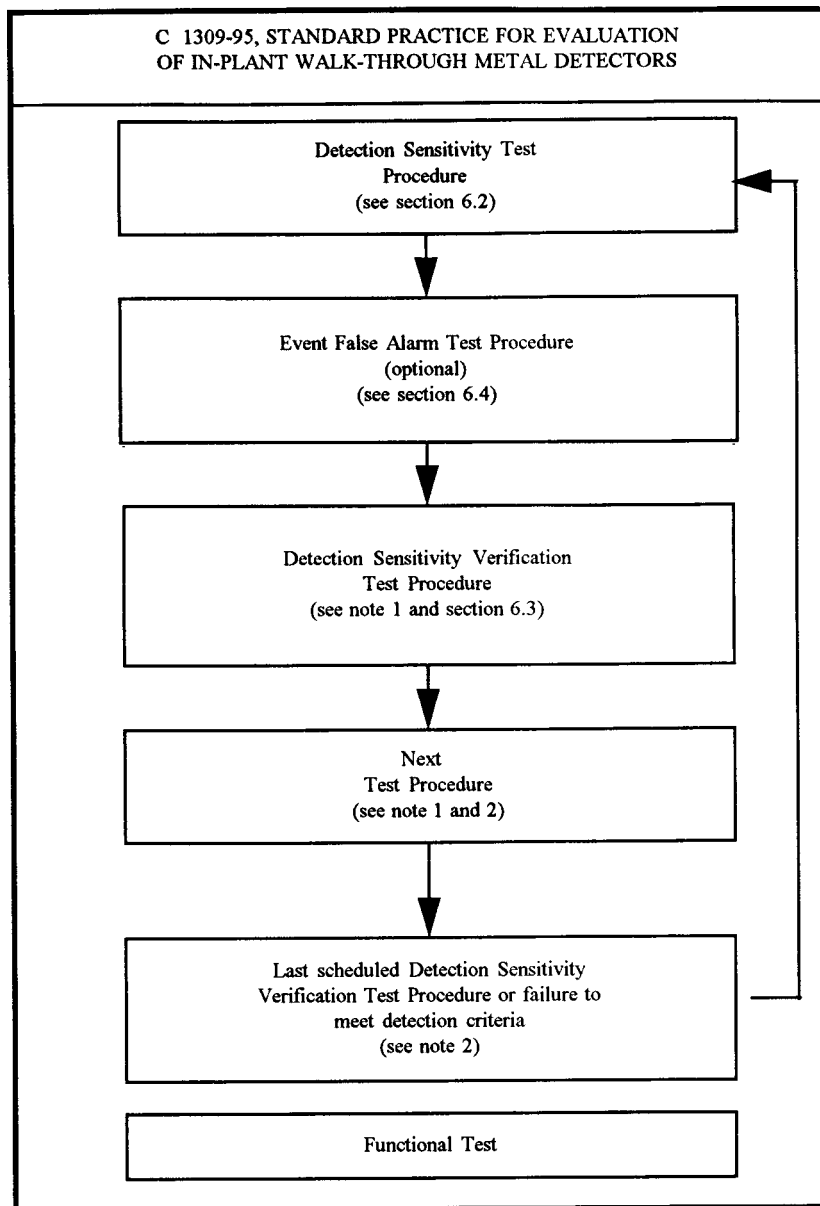

NOTE 1—The number of detection sensitivity verification tests in a series, the number of passes per test, the acceptance criteria, and the frequency may be established by regulatory authority or set by the security organization based on threat scenarios or vulnerability assessments; the numbers should be sufficient to provide a degree of assurance commensurate with the detector application.

NOTE 2—If the detector fails to meet the acceptance criteria, the verification series is terminated. The detector then must be tested to reestablish the probability of detection. If the probability of detection requirement cannot be met (repairs may be necessary), the detector must be mapped and the operational sensitivity setting reestablished. Performance testing can then be resumed starting with a new detection sensitivity test.

NOTE 3—If the detector fails the functional test, the detector must be immediately removed from service (see Appendix X1).

FIG. 1 Walk-Through Metal Detector Evaluation Testing Program

metal buttons, cardiac pacemakers, coins, metal frame eye-glasses, hearing aids, jewelry, keys, mechanical pens and pencils, shoes with metal shanks or arch supports, metallic surgical implants, undergarment support metal, metal zippers, etc. In the absence of other criteria, a clean-tester passing through a metal detector shall not cause a disturbance signal greater than 10 % of that produced when carrying the critical test object through the detector. Test objects requiring very high sensitivity settings for detection require more complete

elimination of extraneous metal to obtain less than 10 % signal disturbance. The tester shall have a weight between 50–104 kg and a height between 1.44–1.93 m. Should a given detector be sensitive to body size because of design or desired sensitivity, the physical size of testers should be smaller and within a narrower range. It is recommended that the clean-tester be surveyed with a high sensitivity hand-held metal detector to ensure that no metal is present.

3.1.2 *critical orientation, n*—the orthogonal orientation of a

test object that produces the smallest detection signal or weakest detection anywhere in the detection zone; the orthogonal orientation of a test object that requires a higher sensitivity setting to be detected compared to the sensitivity settings required to detect the object in all other orthogonal orientations. See Fig. 2 for handgun orientations.

3.1.2.1 *Discussion*—Critical orientations are determined by testing using a mapping procedure such as described in Practice C 1270 (see 3.1.21 and Fig. 3).

3.1.2.2 *Discussion*—The term critical orientation can be applied in two ways. Critical orientation can refer to the worst case orthogonal orientation in a single test path or the worst case orthogonal orientation for all the test paths (the entire detection zone). The two are coincident in the critical test path.

3.1.3 *critical sensitivity setting, n*—the lowest sensitivity setting of a detector at which the critical test object in its critical orientation is consistently detected (10 alarms out of 10 passages) when passed through the detection zone on the critical test path.

3.1.4 *critical test element, n*—see **test element**.

3.1.5 *critical test object, n*—the one test object out of any given group of test objects that, in its critical orientation, produces the weakest detection signal anywhere in the detection zone.

3.1.5.1 *Discussion*—The group referred to consists of one or more objects that are to be detected at the same detector setting.

3.1.5.2 *Discussion*—Depending on the particular detector, some orientation-sensitive test objects may have different critical orientations through different test paths in the detection zone. Hence, care must be taken in determining the critical test object, its critical orientation, and the critical test path.

3.1.6 *critical test path, n*—the straight-line shortest-course path through the portal aperture, as defined by an element on the detection sensitivity map, that produces the smallest detection signal or weakest detection for a test object in its critical orientation (see Fig. 4 and Fig. 2).

3.1.7 *detection sensitivity map* (see Fig. 3 and Appendix X2), *n*—a depiction of the grid used to define test paths through the detection zone, with each element of the grid containing a value, usually the sensitivity setting of the detector, that is indicative of the detectability of the test object.

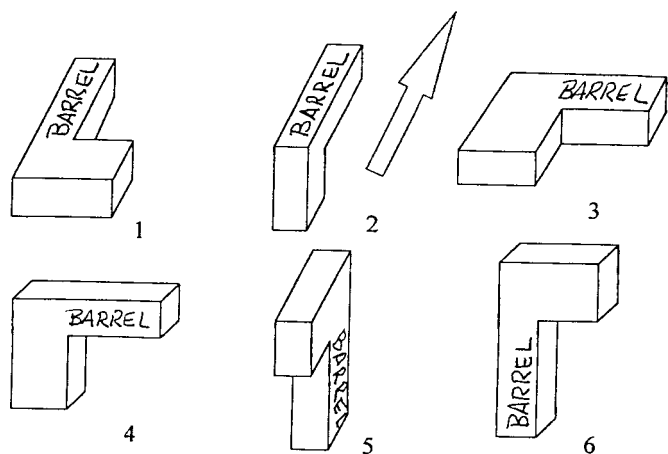

FIG. 2 Six Standard Orthogonal Orientations for a Handgun

52	68	52	52
49	55	75	71
50	52	75	73
48	58	74	70
35	63	81	72
47	62	89	74
47	69	79	75
57	71	81	79
62	74	74	69

critical test element

NOTE 1—Numbers are sensitivity setting values for a hypothetical detector. The numbers represent the lowest sensitivity setting at which the object was detected ten out of ten consecutive test passes through the indicated test path.

FIG. 3 Example of Detection Sensitivity Map

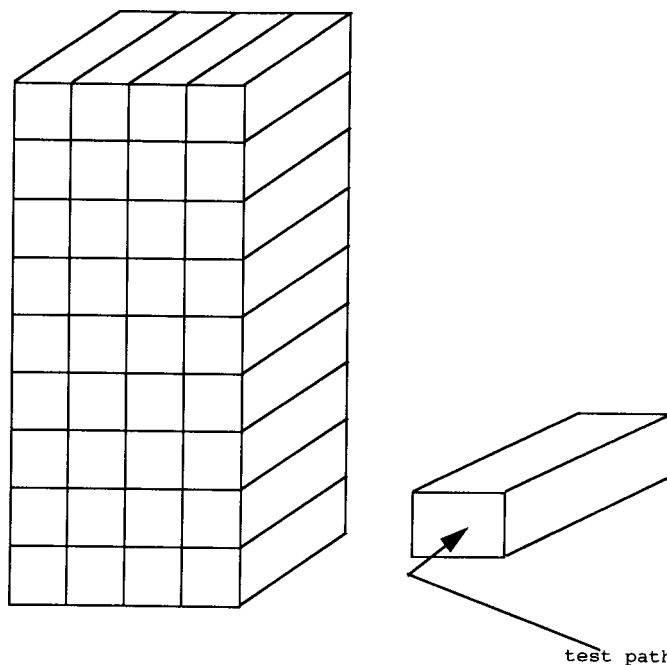



FIG. 4 3-D View of Detection Zones and Test Grid

3.1.7.1 *Discussion*—These values are relative and describe the detection sensitivity pattern within the detection zone for the specific test object. The values are derived by identically testing each defined test path using a specific test object in a single orthogonal orientation. The value is usually the minimum sensitivity setting of the detector that will cause a consistent alarm (10 out of 10 test passes when the test object is passed through the detection field. Appendix X2 is a sample form for a potential detection sensitivity map configuration.)

3.1.8 *detection sensitivity test, n*—see 6.2.

 **C 1309**

3.1.9 *detection sensitivity verification test, n*—see 6.3.

3.1.10 *detection zone, n*—the volume within the portal aperture.

3.1.11 *detector, n*—see walk-through metal detector.

3.1.12 *element, n*—see test element.

3.1.13 *event false alarm, n*—an alarm occurring when a clean-tester, while not carrying a test object, passes through the detection zone of a detector operating at the operational sensitivity setting.

3.1.14 *event false alarm test, n*—see 6.4.

3.1.15 *functional test, n*—see 6.1.

3.1.16 *functional test object, n*—a metallic item that does not necessarily have strict criteria defining its size, form, weight, or composition.

3.1.16.1 *Discussion*—Functional test objects do not test sensitivity; they are gross stimuli used frequently to quickly verify that the aural and visual indicators and alarm circuits are operable.

3.1.16.2 *Discussion*—A functional test object will consistently cause metal detection alarms when a detector is adjusted to detect the critical test object in its critical orientation passing through the critical test path. Detection of the functional test object does not provide assurance that the detector is operating properly or adjusted to detect anything other than the functional test object.

3.1.16.3 *Discussion*—Functional test objects may be items such as large handguns or rifles, metal tools, metal blocks, a person wearing many metallic items, etc. Active devices such as radios and pagers must not be used as functional test objects and must not be carried when performing tests. The functional test object must be at least as detectable as the critical test object in its critical orientation.

3.1.17 *grid, n*—see test grid

3.1.18 *grid element, n*—(1) a single block on a detection sensitivity map; (2) the rectilinear volume through the detection zone defined by coincident elements of identical grid works placed on either side of the portal aperture. (See Figs. 3 and 4)

3.1.18.1 *Discussion*—Grid elements define the bounds of repeatable straight-line shortest-course paths through the detection zone (see Fig. 4).

3.1.19 *in-plant, adj*—installed in the location, position, and operating environment where the device will be routinely used.

3.1.20 *normal screening method, n*—the usual method of passage through a walk-through metal detector during normal operations. For example, the two basic screening methods are “continuous walk” and “pausing in the portal.”

3.1.20.1 *Discussion*—The normal screening method is usually based on the operating characteristics of the detector. A basic rule for metal detector testing is: “Use it like you test it and test it like you use it.”

3.1.21 *orthogonal orientation, n*—as used in this practice, orthogonal orientation refers to alignment of the longitudinal (long) axis of a test object along the XYZ axes of the Cartesian coordinate system; X is horizontal and across the portal; Y is vertical; and Z is in the direction of travel through the portal. (See Fig. 2 for handgun orientations)

3.1.21.1 In the case of firearms, the barrel is always treated

as the longitudinal axis. Fig. 2 illustrates the six standard orthogonal orientations for a handgun.

3.1.22 *performance test log, n*—a record of the operation, testing, and maintenance history of a metal detector.

3.1.22.1 *Discussion*—Appendix X4, Performance Test Log, suggests examples for log content and format.

3.1.23 *portal, n*—see walk-through metal detector.

3.1.24 *shielding test object, n*—a test object representing special nuclear material shielding that might be used in a theft scenario.

3.1.24.1 *Discussion*—It is usually a metallic container or metallic material configured as a credible gamma radiation shield for a specific type and quantity of special nuclear material. The object is specified by a regulatory authority or is based on the facility threat/risk assessment, or both

3.1.25 *test element, n*—(see Fig. 1) for the purpose of testing, it is necessary to define discrete and repeatable straight-line shortest-course test paths through the detection zone. This can be done by using two identical networks (grids) made of nonconductive/nonmagnetic material attached across the entry and exit planes of the portal aperture so the networks coincide. A test object on the end of a probe can then be passed from one side of the portal aperture to the other side through corresponding openings, which results in the test object taking a reasonably straight-line shortest-course path through the detection zone. If the networks are constructed so that they can be put in-place identically each time they are used, then the test paths through the detection zone are repeatable over time. Thus, a test element is the volume of space defined by the boundaries of two corresponding network openings and it represents a straight-line shortest-course path through the detection zone.

3.1.25.1 *Discussion*—On a detection sensitivity map the corresponding networks appear as a rectangular grid with each element of the grid representing a test path through the detection zone. The element defining the critical test path is the critical test element.

3.1.26 *test grid, n*—a network of nonconductive/nonmagnetic material, such as string or tape, can be stretched across the entry and exit planes of the portal aperture to define test paths through the portal aperture; the material should not be hygroscopic.

3.1.26.1 *Discussion*—See Fig. 1 for an example of a 4 by 9 element test grid.

3.1.27 *test path, n*—as defined by an element on a detection sensitivity map, a straight-line shortest-course path through the detection zone of a detector undergoing detection sensitivity or detection sensitivity verification testing. (See Fig. 4)

3.1.28 *test object, n*—metallic item meeting dimension and material criteria used to evaluate detection performance.

3.1.29 *walk-speed (Normal), n*—walkspeed is between 0.5 to 1.3 m/s (1½ to 2½ steps/s).

3.1.29.1 *Discussion*—The average casual walk rate is about 1¾ step/s.

3.1.30 *walk-through metal detector (detector, portal), n*—a free-standing screening device, usually an arch-type portal, using an electromagnetic field within its portal structure (aperture) for detecting metallic objects, specifically weapons

 **C 1309**

and/or metallic shielding material on persons walking through the portal.

3.1.31 *weapon test object, n*—a handgun(s) or simulated handgun(s) designated by or satisfying the regulatory authority requirement for a test object.

3.1.31.1 *Discussion*—Care must be taken when selecting or designing a mock handgun. Simple blocks of metal shaped like a handgun will likely not cause a metal detector to react the same as it would to the intricate shapes and variable components of a real handgun. Most government agencies use actual guns for testing.

4. Interferences

4.1 A number of external and operational interferences may affect sensitivity adjustment and performance test results. These are addressed in Section 5, in each test description, in Practice F 1468, and in Guide C 1238.

4.2 Electrical interference effects are addressed in Practice F 1468 and Guide C 1238.

4.3 The area around a detector should be clear of chairs, tables, trash cans, and other clutter containing metal, and remain unchanged during testing and detector operation. Even small changes in the environment can result in circumstances that may cause improper operation of the detector, particularly detectors operating at high sensitivity levels.

NOTE 1—From an operational standpoint, metal objects of any kind should be eliminated from the area around an operating detector. Even small changes in the location of small amounts of metal near a detector can skew the electromagnetic (EM) field within the portal, resulting in situations where the detection sensitivity map is no longer accurate. Fixed metal, such as rebar in the floor under the detector, will have an effect on the geometry of the EM field but will be taken into account when the detector is mapped in place. It is important not to move the detector from the exact mapping location; movement may change the relative location of fixed metal in relation to the detector and invalidate the detection sensitivity map. Devices emitting radio frequency (RF), even very low levels, should not be near an operational detector. Radio frequency-emitting devices may interact with the EM field or the detector's electronic processes causing operational problems and false alarms.

5. Prerequisites

5.1 The detector sensitivity must be set to the operational sensitivity setting. Practice C 1269 or a similar process may be used for adjusting the operational sensitivity.

5.2 For the detection sensitivity test and detection sensitivity verification test, the detector must have been mapped by some method that identified the worst-case combination of test object, test object orientation, and weakest detection path through the detector aperture. The user may choose to map the detector in accordance with Practice C 1270 or may use some other procedure that provides equivalent data.

NOTE 2—It is advisable to have a thorough understanding of the operational and detection characteristics of each metal detector type before implementing this practice. Each detector has its own operating characteristics and can be affected in different ways by environmental and operating conditions. It is recommended that the basic operating characteristics of detectors be evaluated using procedures such as those outlined in Practice F 1468. If possible, the evaluation should be performed with the detector in the location where it will be used for screening.

5.3 Ensure that the area around the detector contains all materials normally present; no material shall be added to or

removed from the detector operating area purely for performance of this test.

5.4 Ensure that only the tester is within 1 m of the detector.

5.5 Energize all equipment located within 10 m of the detector that is normally “on” during routine operation.

5.6 Radios, pagers, and other electronic equipment that is not part of the building or installed security system should be at least 3 m away.

6. Summary of Tests

6.1 *Functional Test (FT)*—The purpose of the FT is to frequently verify that a detector is operating and will produce the correct alarm signals. Using the normal screening procedure, a tester carries a functional test object through the detection zone. The detector must produce the appropriate alarm response. This test is performed at least daily (see Section 9).

6.2 *Detection Sensitivity Test (DST)*—The purpose of the DST is to acquire data to determine and document the probability of detection after the detector has been set to the operational sensitivity setting. The DST is performed following any detection sensitivity adjustment or at intervals set by the testing schedule or as required by the regulatory agency.

6.2.1 Using the normal screening method, a clean-tester carries the critical test object in its critical orientation through the detection zone in the critical test path. The pass is repeated a statistically significant number of times; the number of passages (see Appendix X3) is based on the regulatory requirements. The number of alarms is noted and a determination is made as to whether the probability of detection requirement has been met. If the data indicates the detection requirement is satisfied, the detector may be put into operation. If the data fails to satisfy the requirement, the operational sensitivity setting must be readjusted and the detection sensitivity test rerun (see Section 10).

6.3 *Detection Sensitivity Verification Test (DSVT)*—The purpose of the DSVT is to periodically establish whether a detector continues to function at the required detection probability as established by a DST. The DSVT is identical to the DST, except fewer passages are required. The test results are added to those from the most recent DST and any intervening DSVTs to provide an accumulated result demonstrating the detection rate.⁵ The DSVT is performed at intervals set by the testing schedule, usually at least monthly.

6.3.1 In addition to the basic DSVT described in 6.3, a number of optional passages can be performed with a variety of test objects and test object orientations. These tests provide a modest degree of confidence that a detector continues to operate as mapped (see Section 11).

⁵ When using accumulated results, it is necessary to meet certain criteria: (1) the detector must have remained undisturbed (that is, not been adjusted, moved, repaired, or recalibrated) since the detection sensitivity test; (2) all results obtained during the period between the detection sensitivity test and the latest detection sensitivity verification test must be included in the accumulated total; and (3) the results for a single detection sensitivity verification test cannot indicate a detection rate less than the regulatory requirement. For example, if a detection rate of 0.85 at 95 % confidence is required and if the DSVT uses ten test passes, then all ten passes must cause the detector to alarm. If the detector fails to alarm on one of the ten passes, then 20 additional passes resulting in alarms must be made to satisfy the 0.85 at 95 % requirement.

 **C 1309**

6.4 *Event False Alarm Test (EFAT)*—The EFAT verifies that the alarms obtained during the detection sensitivity test were the result of detecting the test object and ensures that the operational sensitivity setting will not be the cause of an inordinate number of nuisance or false alarms. It is performed only after the detection sensitivity test.

6.4.1 Using the normal screening procedure, a clean-tester without the test object makes a number of passages through the detector; the number of passages is determined by the false alarm probability of occurrence requirement of the regulatory agency. If the number of alarms exceeds the allowable limit, it indicates that the detector and detector installation should be evaluated for faults and environmental interferences, respectively.

6.4.2 If the detector or detector installation require repair or changes to correct the situation it is necessary to remap the detection sensitivity pattern within the detection zone aperture, readjust the detector to the operational sensitivity setting, and establish the initial detection rate by performing a detection sensitivity test. The EFAT must then again be performed to verify the detector and installation are satisfactory (see Section 12).

7. Significance and Use

7.1 Walk-through metal detectors are an effective and unobtrusive means for searching for concealed metallic weapons and SNM (special nuclear material) shielding material. The detectors are generally applied to prevent the unauthorized entry of weapons into facilities, and theft or unauthorized removal of SNM. Daily functional testing of metal detectors shows that they are operating and will produce the correct alarm signal; the significant use of less frequent in-plant evaluations provides data from which to determine if detectors are operating at expected performance levels.

7.2 This practice provides a system of procedures for evaluating the detection performance of walk-through metal detectors.

7.3 The procedures specify data to be recorded and used for establishing, tracking, and auditing metal detector performance and operation.

7.4 This practice suggests documentation for maintaining performance records. Appendix X4 provides examples of forms for recording and tracking detector operation and performance testing.

8. Precautions

8.1 This testing scheme assumes no changes in the metal detection pattern or sensitivity from the time of initial detection sensitivity mapping. If an event or circumstance has occurred that may effect a change in the detection field or sensitivity, such as damage to the detector or changes in the operating environment, the detection zone should be mapped. The detector must be mapped following maintenance on the detector controller or archway internal components after significant movement or relocation of the detector for any reason, and when the physical surroundings, electrical and mechanical equipment, or furnishings are added, removed, or substantially changed within approximately 3 m of the detector. Changes involving large masses of metal or electrical devices may have

effects of up to 10 m or more. It is suggested that detectors be mapped annually as part of a maintenance program to ensure no unrecognized changes have taken place in the detector or its environment that affect detection performance.

9. Functional Test

9.1 *Scope*—This procedure verifies that the detector produces the expected alarm response when subjected to a functional test object.

9.2 *Frequency*—This test should be performed at least once a day and preferably during each shift. Regulatory authorities may specify frequency.

9.3 *Functional Test Object* (see 3.1.16)—As predetermined by testing or specified by the regulatory authority.

9.4 *Acceptance Criteria:*

9.4.1 The detector produces the expected alarm response before the tester exits the detection zone.

9.5 *Test Procedure:*

9.5.1 Starting from a point at least 1 m away from the detector aperture and using the normal screening procedure and direction, the tester proceeds through the detection zone to a point at least 1 m on the other side of the detector.

9.5.2 *Test Result Determination:*

9.5.2.1 If the acceptance criterion is met, the detector may remain in service.

9.5.2.2 If the acceptance criterion is not met, the detector should be removed from service. Corrective action is indicated.

9.6 *Test Documentation:*

9.6.1 The test result should be recorded in testing records. As a minimum, the entry should include the outcome (pass/fail), the date and time of the test, and the initials or signature of the person performing or witnessing the test, or both. If available, the sensitivity setting should also be recorded.

9.6.2 If the detector fails, a description of the failure, actions taken, and the person(s) or organization notified (if appropriate) should be recorded in the testing record.

10. Detection Sensitivity Test (DST)

10.1 *Scope*—Within the practical limits of field testing, this procedure verifies that the detection sensitivity is adequate to detect the critical test object in its critical orientation as it passes through the detection zone on the critical test path. It also provides data from which to establish the probability of detection.

10.2 *Frequency*—This procedure is performed after the detection sensitivity adjustment and as required by a testing schedule. It is suggested it be performed quarterly but no less than once a year. Regulatory authorities may specify test frequency.

10.3 *Test Object*— This procedure uses test object(s) specified by the responsible regulatory authority or as determined by the user and agreed to by the regulatory authority.

10.4 *Prerequisites:*

10.4.1 The tester must be a clean-tester as described in 3.1.

10.4.2 Verify that the detector sensitivity setting has not been changed since the performance of the last operational sensitivity adjustment or detection sensitivity verification test. Any discrepancy is cause for suspicion of tampering; the detector should be immediately removed from service, the

responsible security representative notified, and the discrepancy(ies) noted in the test record.

10.4.3 Select the appropriate critical test object (weapon or shielding) for the test being performed.

10.4.4 Refer to the detection sensitivity map for the detector being tested. Select a critical test path in the space normally occupied by persons passing through the detection zone. This test path is used for all passages. Record or note on the detection sensitivity map and data sheet which test element is used for the test. This information will be required for the DSVT (see Section 11).

10.4.5 In the case of detectors used bidirectionally, ensure testing is performed at least using the worst-case direction of travel (see Note 3) and the appropriate test object for that direction. Testing in both directions may be preferable.

NOTE 3—Some detectors apparently are more sensitive in one direction of travel than the other. Other detectors will perform identically in both directions; the sensitivity patterns will be mirror image, of course. Regardless, if a detector is used bidirectionally, both directions should be mapped to determine the detection sensitivity pattern, critical test object and orientation, and critical test path. The detector should be tested in the direction requiring the highest sensitivity setting for detection of the test object.

10.5 *Acceptance Criteria*—The number of alarms versus passages meets the detection requirement (see Appendix X3).

10.6 Procedure:

10.6.1 Position the test object in its critical orientation on the clean-tester so that it will pass through the detection zone in the critical test path.

10.6.2 The tester should start from a point at least 1 m away from the detector aperture and proceed through the detection zone using the normal screening procedure to a point at least 1 m on the other side.

10.6.3 The tester should return to the starting point after each passage; allow the detector to settle 5 to 10 s before the next pass. Note the result of each passage.

10.6.4 Perform the number of passages needed to satisfy the regulatory requirement.

10.6.5 Test Result Determination and Actions:

10.6.5.1 If acceptance criteria was met, perform the Event False Alarm Test described in Section 12, if required by the regulatory authority.

10.6.5.2 If the acceptance criteria was not met, terminate testing. Corrective action, mapping, operational sensitivity adjustment, and retesting is the indicated process to be followed.

10.6.6 Test Documentation:

10.6.6.1 The test result should be recorded. As a minimum, the entry should include the outcome (alarms/passes), the date and time of the test, and the initials or signature of the person(s) performing or witnessing the test, or both. If available, the sensitivity setting should also be recorded.

10.6.6.2 If the detector fails, a description of the failure, actions taken, and the person(s) or organization notified (if appropriate) should be noted in the testing record.

11. Detection Sensitivity Verification Test (DSVT)

11.1 *Scope*—Within the practical limits of field testing, this procedure routinely provides a level of confidence that the

detection sensitivity continues to meet or exceed the detection probability established by the detection sensitivity test.

11.1.1 This procedure is identical to the DST except for fewer test passes, which is determined to satisfy the regulator's requirements. The results of the DSVT are added to the results of the DST and any previous DSVTs to provide a cumulative indicator of detection performance over time (see Appendix X3). The acceptance criteria logic and procedural steps will not allow the detector to be operated at a level below the regulatory requirement appropriate to the detector.

11.1.2 This procedure also provides an optional qualitative test that provides a degree of assurance that the operating characteristics of a detector have not changed over time. These tests use noncritical test objects or the critical test object in noncritical orientations or noncritical test paths to check for possible changes in the shape or intensity of the detection sensitivity field.

11.2 *Frequency*—This test is performed periodically or at least monthly. The responsible regulatory authority may specify test frequency.

11.3 *Test Object*—The test object used for evaluating the detection probability is the same as that used for the previous DST. The test object(s) used for the optional tests may be selected from the group of threat weapons/SNM shields specified by the responsible regulatory authority or as determined by user testing and agreed to by the regulatory authority, or both.

11.4 Prerequisites:

11.4.1 The tester must be a clean-tester as described in 3.1.

11.4.2 Verify that the detector settings are the same as used during the most recent DST from the appropriate documentation.

11.4.3 Select the appropriate critical test object(s).

11.4.4 Note the critical test path used in the DST.

11.4.5 In the case of detectors used bidirectionally, ensure testing is performed in accordance with the DST.

11.5 *Acceptance Criteria*—The detector alarms on all passages, or meets the criteria specified in the procedure.

11.6 Procedure:

11.6.1 The tester should start from a point at least 1 m away from the detector aperture and proceed through the detection zone in the normal operating fashion to a point at least 1 m on the other side.

11.6.2 The tester should return to the starting point after each passage; allow the detector to settle 5 to 10 s before the next pass. Note the result of each passage.

11.6.3 Critical Path Testing:

11.6.3.1 Position the critical test object on the clean-tester so that it will pass through the critical test path in the critical orientation.

11.6.3.2 Perform the number of test passes necessary to satisfy the detection requirement or level of confidence appropriate for the detector application.

NOTE 4—The frequency of testing and the number of test passes may be specified by the regulator or determined by threat scenarios or a vulnerability assessment. The more important or critical the role of the detector is in the protection program, the more often and thoroughly it should be tested to provide a level of confidence commensurate with its application.

 **C 1309**

11.6.3.3 Test Result Determination and Actions:

(1) If all passes of the set result with alarms, then the acceptance criteria was met and the detector may remain in service. Accumulate the test results with those of previous DSVTs and the DST. Note the results in the test record.

(2) If a single pass of the set results with no alarm, further testing is required to determine if the detector is still operating at the required level. Refer to the probability of detection tables in Appendix X3. Locate the column for the appropriate detection value and follow it down to the first entry. This is the minimum number of additional passages with successive detections that are required to revalidate the detection performance level to that established during the DST. If any non-detections occur during these additional passes, the performance of the detector is questionable and it should be removed from service. Corrective action, mapping, operational sensitivity adjustment, and retesting is the indicated process to be followed.

(3) If two or more passes of the set result with no alarms, then the acceptance criteria cannot be met; terminate testing. Corrective action, mapping, operational sensitivity adjustment, and retesting is the indicated process to be followed.

11.6.4 Qualitative Testing (optional)—The following should be performed with each noncritical test object. It may be beneficial to establish a rotational regimen so that all positions are tested over a period of time.

11.6.4.1 Position a noncritical test object in one of the three test positions (ankle, waist, or head) on the clean-tester in one of the six normal orthogonal orientations.

11.6.4.2 Perform three passes; all must result in alarms.

11.6.4.3 Test Result Determination and Actions:

(1) If the acceptance criteria was met, the detector may remain in service.

(2) If the acceptance criteria was not met, terminate testing. Corrective action, mapping, operational sensitivity adjustment, and retesting is the indicated process to be followed.

NOTE 5—Because none of these configurations is worst-case, any failure to alarm should be considered serious. However, a circumstance may be encountered where the noncritical test object in a particular orientation has a detection sensitivity threshold very nearly the same as the worst-case test object in its worst-case orientation/test path. It is foreseeable in this circumstance that a non-detection may occur similarly to a non-detection in the worst-case scenario. The safest practice is to readjust the detector and retest in accordance with this practice. However, if the performance history of the detector indicates that this single failure may be a statistical event, retesting the non-critical test object in the non-alarm test path may be acceptable. The detector sensitivity control setting must remain unchanged and the number of test passes must be sufficient to establish that the detection requirement is being met. If no requirement has otherwise been established, an appropriate number of trials is five.

11.6.5 Test Documentation:

11.6.5.1 Test results should be recorded. As a minimum, the entry should include the outcome (alarms/passes) of all testing, the date and time of the test, and the initials or signature of the person(s) performing or witnessing the test, or both. If available, the sensitivity setting also should be recorded.

11.6.5.2 If the detector failed to meet the criteria, then the failure mode, action taken, and the person(s) or organization notified (if appropriate) should be noted in the testing record.

12. Event False Alarm Test

12.1 Scope—This test verifies that the operational sensitivity setting will not cause an unacceptably high event false alarm percentage and that the alarms observed during the detection sensitivity test were caused by the test object and not the clean-tester.

12.2 Frequency—This test is performed after the completion of the detection sensitivity test.

12.3 Test Object— None.

12.4 Prerequisites:

12.4.1 If a regulatory authority requirement for false alarm rate or probability of occurrence is applicable, determine the number of passes that must be made to satisfy the requirement.

12.4.2 The tester must be a clean-tester as described in 3.1.

12.5 Acceptance Criteria:

12.5.1 If applicable, as required by the regulatory authority requirements.

12.6 Procedure:

12.6.1 Starting from a point at least 1 m away from the detector aperture, a clean-tester proceeds through the detection zone using the normal screening procedure to a point at least 1 m on the other side. Passage direction/method must be the same as used for the detection sensitivity test.

12.6.2 Test Result Determination and Actions:

12.6.2.1 If the acceptance criteria is met, the detector may be put into service.

12.6.2.2 If the event false alarm acceptance criteria is not met and no external cause can be identified, upgrading of the detector or installation may be indicated. An evaluation of the EFAT and its impact on operations should be made by a responsible authority to determine if operation of the detector is acceptable.

12.6.3 Test Documentation:

12.6.3.1 Test result should be recorded in the testing record. The entry should include, as a minimum, the number of test passes and alarms, the date and time of the test and the initials or signature of the person performing or witnessing the test, or both.

12.6.3.2 If the detector failed to meet the criteria, the failure mode and action taken should be included in the test record.

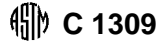

APPENDIXES

(Nonmandatory Information)

X1. METAL DETECTOR PROCEDURE LOGIC FLOW DIAGRAM

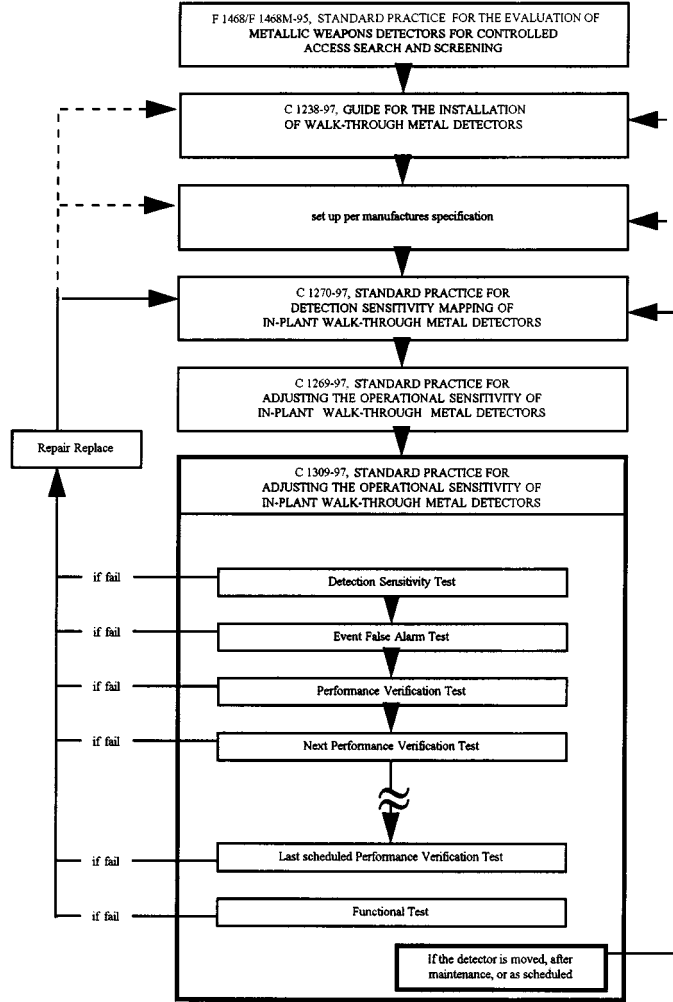

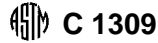

X2. FORM—DETECTION SENSITIVITY MAP

1	2	3	4
5	6	7	8
9	10	11	12
13	14	15	16
17	18	19	20
21	22	23	24
25	26	27	28
29	30	31	32
33	34	35	36

Manufacturer: _____
 Model: _____
 Date Tested: _____
 Location: _____
 Parameter Settings: _____

Weapon Test Object ID No.: _____
 Shielding Test Object ID No.: _____
 Tester sign: _____
 Verification sign.: _____
 Orientation: _____

Note: Important--ensure the location of the transmitter and receiver are identified. If the detector does not have a dedicated transmitter and receiver, note the side from which testing is performed relative to the protected area.

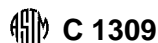

X3. PROBABILITY OF DETECTION TABLES

X3.1 Acceptance criteria for various detection probabilities and numbers of total trials are illustrated in Table X3.1, Table X3.2, and Table X3.3. The total number of trials and number of detections can be the result of one evaluation or they can be results accumulated over a period of time from a number of evaluations, as long as the same test object is used and the detector has been in continuous operation during the period without recalibration, adjustment, or repair. When using accumulated results, all results obtained during the period must be included. If a detector has required repair, adjustment, or recalibration, only results accumulated afterward can be used to evaluate the detector's performance.

X3.2 Example of Using Table X3.1:

X3.2.1 Suppose that a facility evaluates a detector once a week using ten trials with a particular test object and accumulates results for ten weeks. If the results total 94 detections and 6 misses for 100 trials, the 100 trials row in Table X3.1 gives a point estimate of 0.85 for the detection probability over the ten-week period.

X3.2.2 Fifteen weeks later, assuming the detector for some reason still has not been recalibrated, if the accumulated results

TABLE X3.1 Detection Criteria for Verifying Detection Probability

Total Number of Trials	Number of Detections or More Required to Verify a Detection Probability of: ^A					
	0.50	0.75	0.80	0.85	0.90	0.95
5	5	^B
10	9
15	12	14
20	15	19	20	20
30	20	27	28	29	30	...
40	26	35	37	38	40	...
50	32	43	45	47	49	...
100	59	83	87	92	96	99
250	139	200	211	223	234	244
1000	527	774	822	869	916	962

^AFor total trials from a single evaluation, the detection probability is estimated to be greater than the column heading value with at least 95 % confidence. For accumulated trials from more than one evaluation, the column heading is a point estimate of the detection probability.

^BAn inadequate total number of passages to estimate the indicated detection probability with 95 % confidence.

TABLE X3.2 Probability of Detection Table for 0.85, 0.90, and 0.95 at 95 % Confidence

Total Number of Trials	Number of Detections or More Required to Verify Detection Probability of: ^A		
	0.85	0.90	0.95
20	20	^B	^B
30	29	30	...
40	38	40	...
50	47	49	...
60	56	59	...
70	65	68	...
80	74	77	...
90	83	86	...
100	92	96	99
110	100	105	109
120	109	114	119
130	118	123	128
140	127	132	138
150	136	141	148
160	144	150	157
170	153	159	167
180	162	168	177
190	170	177	186
200	179	186	196
^C

^AFor total trials from a single evaluation, the detection probability is estimated to be greater than the column heading value with at least 95 % confidence. For accumulated trials from more than one evaluation, the column heading is a point estimate of the detection probability.

^BAn inadequate total number of passages to estimate the indicated detection probability with 95 % confidence.

^CFor total test numbers higher than 200 use the approximation:

Successful Tests (0.85): $0.895 \times \text{Total Tests}$
 (0.90): $0.933 \times \text{Total Tests}$
 (0.95): $0.980 \times \text{Total Tests}$

are 235 detections and 15 misses out of 250 total trials, the 250 trial row gives a point estimate of 0.90 for the detection probability over the 15-week period.

X3.2.3 At this point, suppose the detector is recalibrated, and the initial ten trials provided nine detections. Table X3.1 then shows that the detector's probability is verified to be at least 0.50 with a 95 % confidence. At this point, no accumulated data from previous evaluations can be included because of the recalibration.

 **C 1309**

**TABLE X3.3 Probability of Detection Table for Lower 95 %
Confidence Limit**

Total Number of Trials	Number of Detections	Probability of Detection	
30	30	90.5	
	40	88.7	
40	40	92.8	
	50	87.9	
	49	90.9	
50	50	94.2	
	60	87.6	
	58	89.9	
	59	92.3	
60	60	95.1	
	70	89.3	
	68	91.3	
	69	93.4	
	70	95.8	
70	76	88.9	
	77	90.6	
	78	92.3	
	79	94.2	
	80	96.3	
	80	85	88.7
		86	90.1
87		91.6	
88		93.2	
89		94.8	
90		96.7	
90	95	89.8	
	96	91.1	
	97	92.4	
	98	93.8	
	99	95.3	
	100	97.0	

X4. PERFORMANCE LOG

X4.1 A performance log is a unifying method for organizing and maintaining test documentation and maintenance records for a detector.

X4.1.1 The content and administration of performance logs should be based on quality assurance (QA) principles, particularly if the log is used as documentation of detector performance for regulatory authority audits. This appendix suggests the content for such a log that should satisfy most QA regimens.

X4.1.2 The performance log should contain the information required to validate conformance to applicable regulatory detection performance requirements.

X4.1.3 The performance log should contain records of or reference to all maintenance actions.

X4.1.4 The party responsible for the metal detector performance should be responsible for control and maintenance of the log.

X4.2 Log Sections:

X4.2.1 Requirements and Test Procedures.

X4.2.2 Signature/Initial Verification Log (Fig. X4.1) provides linkage between an individual’s signature/initial and printed name.

X4.2.3 Detection Sensitivity Map.

X4.2.4 Performance Test Data Sheets (Fig. X4.2).

X4.2.4.1 Functional Test Results.

X4.2.4.2 Detection Sensitivity Test Results.

X4.2.4.3 Event False Alarm Test Results.

X4.2.4.4 Performance Verification Test Results.

X4.2.4.5 Maintenance Records or reference to the records.

X4.2.5 *Remarks*—All entries in the Remarks section shall be accompanied by the signature of the person making the entry, the date, and the time.

X4.3 Appendixes (optional):

X4.3.1 Post Orders applicable to operation of the metal detector.

X4.3.2 Copy of the Preventive Maintenance schedule and procedures.

ASTM C 1309

SIGNATURE/INITIAL VERIFICATION JOB			
Location _____		Machine Ser.# _____	
DATE	PRINTED NAME	SIGNATURE	INITIAL

FIG. X4.1 Example of Signature and Initial Verification Log

NOTICE: This standard has either been superseded and replaced by a new version or discontinued. Contact ASTM International (www.astm.org) for the latest information.



EVALUATION TESTING DATA SHEET - METAL DETECTOR												
Location: _____		Manufacturer: _____					Serial # _____					
DATE	TIME	S E E N T S ' E G	INITIAL	FUNCTIONAL TEST			DETECTION SENSITIVITY TEST		PERFORMANCE VERIFICATION TEST		NONCRITICAL TEST OBJECT TEST	
				1	2	3	TEST PASSES	ALARMS	TEST PASSES	ALARMS	TOTAL PASSES	TOTAL ALARMS

FIG. X4.2 Example of Performance Testing Data Sheet

The American Society for Testing and Materials takes no position respecting the validity of any patent rights asserted in connection with any item mentioned in this standard. Users of this standard are expressly advised that determination of the validity of any such patent rights, and the risk of infringement of such rights, are entirely their own responsibility.

This standard is subject to revision at any time by the responsible technical committee and must be reviewed every five years and if not revised, either reapproved or withdrawn. Your comments are invited either for revision of this standard or for additional standards and should be addressed to ASTM Headquarters. Your comments will receive careful consideration at a meeting of the responsible technical committee, which you may attend. If you feel that your comments have not received a fair hearing you should make your views known to the ASTM Committee on Standards, at the address shown below.

This standard is copyrighted by ASTM, 100 Barr Harbor Drive, PO Box C700, West Conshohocken, PA 19428-2959, United States. Individual reprints (single or multiple copies) of this standard may be obtained by contacting ASTM at the above address or at 610-832-9585 (phone), 610-832-9555 (fax), or service@astm.org (e-mail); or through the ASTM website (www.astm.org).