



Standard Test Method for Shear and Bending Fatigue Testing of Calcium Phosphate and Metallic Medical and Composite Calcium Phosphate/ Metallic Coatings¹

This standard is issued under the fixed designation F 1160; the number immediately following the designation indicates the year of original adoption or, in the case of revision, the year of last revision. A number in parentheses indicates the year of last reapproval. A superscript epsilon (ϵ) indicates an editorial change since the last revision or reapproval.

^{ε1} NOTE—Editorial corrections were made to 1.1, 8.1, 8.2, and 9.5.1.2 in June 2001.

1. Scope

1.1 This test method covers the procedure for determining the shear and bending fatigue performance of calcium phosphate coatings and of porous and nonporous metallic coatings and for determining the bending fatigue performance of metallic coatings oversprayed with calcium phosphate. This test method has been established based on plasma-sprayed titanium and plasma-sprayed hydroxylapatite coatings. The efficacy of this test method for other coatings has not been established. In the shear fatigue mode this test method evaluates the adhesive and cohesive properties of the coating on a metallic substrate. In the bending fatigue mode this test method evaluates both the adhesion of the coating as well as the effects that the coating may have on the substrate material. These methods are limited to testing in air at ambient temperature. These test methods are not intended for application in fatigue tests of components or devices; however, the test method which most closely replicates the actual loading configuration is preferred.

1.2 The values stated in SI units are to be regarded as the standard.

1.3 *This standard does not purport to address all of the safety concerns, if any, associated with its use. It is the responsibility of the user of this standard to establish appropriate safety and health practices and determine the applicability of regulatory limitations prior to use.*

2. Referenced Documents

2.1 ASTM Standards:

E 6 Terminology Relating to Methods of Mechanical Testing²

E 206 Definitions of Terms Relating to Fatigue Testing and the Statistical Analysis of Fatigue Data³

E 466 Practice for Conducting Force Controlled Constant Amplitude Axial Fatigue Tests of Metallic Materials²

E 467 Practice for Verification of Constant Amplitude Dynamic Loads on Displacements in an Axial Load Fatigue Testing Machine²

E 468 Practice for Presentation of Constant Amplitude Fatigue Test Results for Metallic Materials²

E 1012 Practice for Verification of Specimen Alignment Under Tensile Loading²

3. Definitions

3.1 The definitions of terms relating to shear and fatigue testing appearing in Terminology E 6 shall be considered as applying to the terms used in this test method.

4. Summary of Test Method

4.1 Shear Fatigue Testing:

4.1.1 The intent of the shear fatigue test is to determine the adhesive or cohesive strength, or both, of the coating.

4.1.2 This test method is designed to allow the coating to fail at either the coating/substrate interface, within the coating, or at the glue/coating interface between the coating and the adhesive bonding agent used to transmit the load to the coating.

4.2 Bending Fatigue Testing:

4.2.1 The primary intent of the bending fatigue test is to quantify the effect that the coating has on the substrate it is applied to. Secondly, it may be used to provide a subjective evaluation of coating adhesion, (that is, spalling resistance, cracking resistance, and so forth).

4.2.2 This test is designed to first provide a substrate fatigue strength to serve as a baseline to assess the effects of the coating on the resulting fatigue strength of the system.

5. Significance and Use

5.1 The shear and bending fatigue tests are used to determine the effect of variations in material, geometry, surface condition, stress, and so forth, on the fatigue resistance of coated metallic materials subjected to direct stress for up to 10^7 cycles. These tests may be used as a relative guide to the selection of coated materials for service under condition of repeated stress.

¹ This test method is under the jurisdiction of ASTM Committee F04 on Medical and Surgical Materials and Devices and is the direct responsibility of Subcommittee F04.15 on Materials Test Methods.

Current edition approved Nov. 10, 2000. Published January 2001. Originally published as F 1160 – 91. Last previous edition F 1160 – 98.

² *Annual Book of ASTM Standards*, Vol 03.01.

³ Discontinued 1988, see *Annual Book of ASTM Standards*, Vol 03.01; replaced by Terminology E 1823.

5.2 In order that such basic fatigue data be comparable, reproducible, and can be correlated among laboratories, it is essential that uniform fatigue practices be established.

5.3 The results of the fatigue test may be used for basic material property design. Actual components should not be tested using these test methods.

6. Equipment Characteristics

6.1 Equipment characteristics shall be in accordance with Practice E 466, Section 7.

6.2 *Shear Fatigue Test Grips:*

6.2.1 *General*—Various types of grips may be used to transmit the load to the specimens by the testing machine. To ensure axial shear stress, it is important that the specimen axis coincide with the centerline of the heads of the testing machine and that the coating test plane be parallel to the axial load. Any departure from this requirement (that is, any eccentric loading) will introduce bending stresses that are not included in the usual stress calculation (force/cross-sectional area).

6.2.2 A drawing of a typical gripping device for the test assembly is shown in Fig. 1.

6.2.3 Fig. 2 shows a drawing of the adaptor to mate the shear fixture to the tensile machine

6.2.4 Figs. 3 and 4 show a schematics of the test setup.

6.3 *Bending Fatigue Test Grips*—There are a variety of testing machines that may be employed for this test (that is, rotating beam fatigue machines and axial fatigue machines). The gripping method for each type of equipment shall be determined by either the manufacturer of that equipment (rotating beam machines) or the user.

7. Adhesive Bonding Materials

7.1 *Adhesive Bonding Agent*—A polymeric adhesive bonding agent in film form, or filled viscous adhesive cement, shall be identified and shall meet the following requirements.

7.1.1 The bonding agent shall be capable of bonding the coating on the test specimen components with an adhesive shear strength that is at least 34.5 MPa (5000 psi) or as great as the minimum required adhesion or cohesion strength of the coating, whichever is greater.

7.1.2 In instances where coating porosity extends to the coating/substrate interface, the bonding agent shall be suffi-

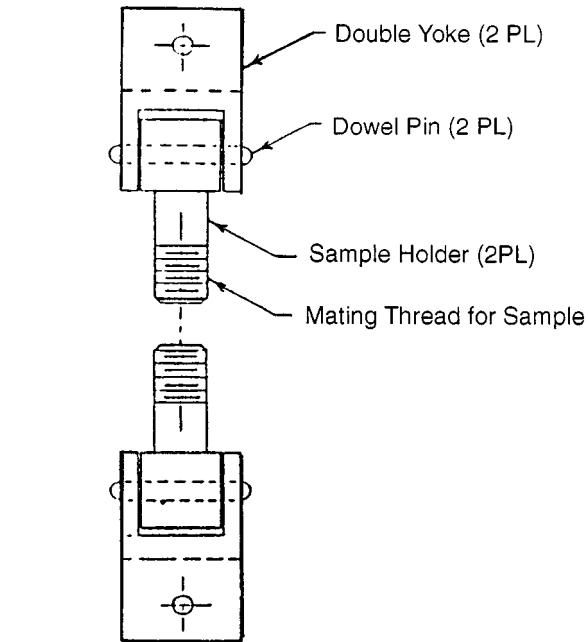

FIG. 2 Adaptor to Mate the Gripping Device to the Tensile Machine

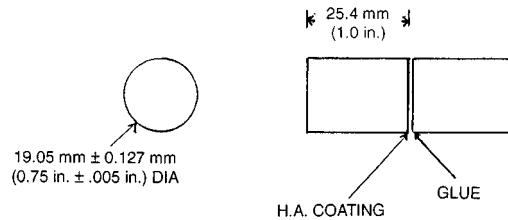

FIG. 3 Schematic of the Shear Test Setup

ciently viscous and application to the coating sufficiently detailed, to ensure that it will not penetrate through the coating to the substrate. The FM 1000 Adhesive Film⁴ with a thickness of 0.25 mm (0.01 in.) has proven satisfactory for this test.

7.1.3 If a material other than FM 1000 is used, or the condition of the FM 1000 is unknown, it must be tested to establish its equivalence to fresh FM 1000. Testing should be performed without the presence of the coating to establish the performance of the adhesive.

8. Test Specimen

8.1 *Shear Fatigue Specimen for Calcium Phosphate and Metallic Coatings Only:*

8.1.1 The recommended shear test specimen and setup is illustrated in Figs. 3 and 4, respectively. A complete assembled test assembly consists of two solid pieces, one with a coated surface and the other with an uncoated surface. The uncoated surface may be roughened to aid in the adhesion of the adhesive bonding agent.

8.1.2 The cross-sectional area of the substrate upon which the coating is applied shall be a nominal 2.85 cm² (0.44 in.²). When specimens of another cross-sectional area are used, the

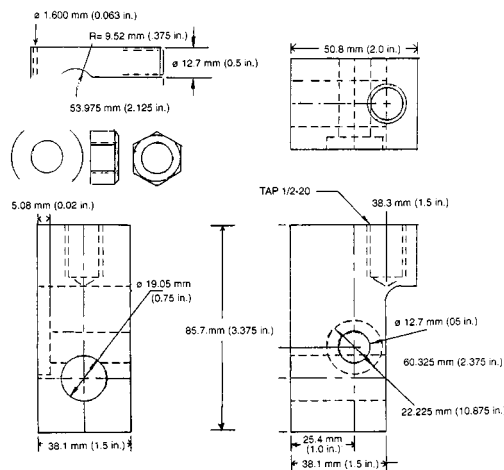

FIG. 1 Gripping Device for Shear Testing

⁴ Available from Cytec, Harve de Grace, MD.

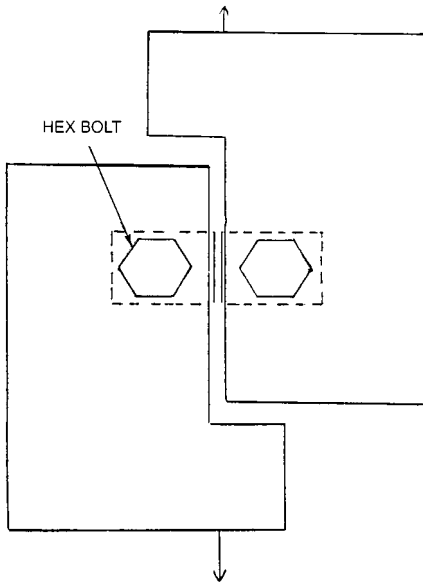

FIG. 4 Drawing of the Recommended Shear Test Specimen Assembly

data must be demonstrated to be equivalent to the results produced using the 2.85-cm² standard cross-sectional area and the specimen size should be reported.

8.2 *Bending Fatigue Specimen for Calcium Phosphate, Metallic, and Calcium Phosphate-Metallic Composite Coatings:*

8.2.1 The type of specimen used will depend upon the objective of the test program, the type of equipment, the equipment capacity, and the form in which the material is available. However, the design must meet certain general criteria as follows:

8.2.1.1 The design of the specimen should be such that if specimen failure should occur, it should occur in the test section (reduced area as shown in Figs. 5-8).

8.2.1.2 Specimens using a flat tapered beam configuration should be designed such that a constant surface stress exists in the test section when the specimen is constrained at one end and point loaded perpendicular to the beam axis at the other end (that is, cantilever loading).

8.2.1.3 Rotating beam specimens may have unique dimensions, depending upon the type of machine used. Appropriate manufacturers' specifications for these specimens should be used.

8.3 *Specimen Coating Preparation:*

8.3.1 Coatings may be applied by any one of a number of techniques. All test specimens for coating characterization shall be prepared from indicative coating lots, using production feedstock lots and be coated on the same equipment used for

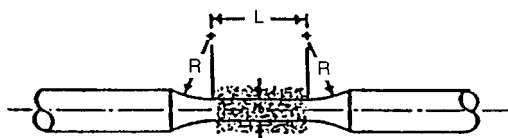

FIG. 5 Bending Fatigue Specimen With Tangentially Blending Fillets Between the Test Section and the Ends for Rotating Beam or Axial Loading

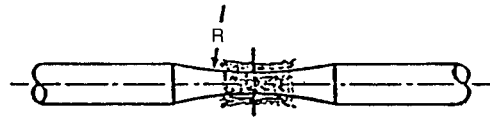

FIG. 6 Specimens With a Continuous Radius Between the Ends for Rotating Beam or Axial Loading

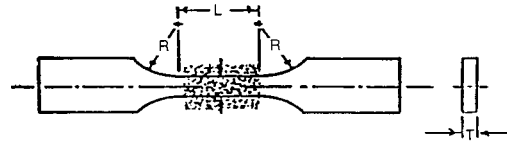

FIG. 7 Specimens With Tangentially Blending Fillets Between the Uniform Test Section and the Ends for Axial Loading

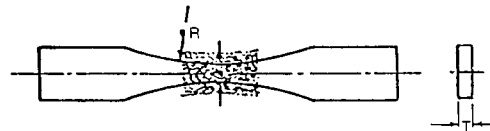

FIG. 8 Specimens With a Continuous Radius Between the Ends for Axial Loading

actual implants. The coating should consist of a layer which is mechanically or chemically attached and covers the surface.

8.3.2 Coatings should be applied as follows:

8.3.2.1 For the shear fatigue specimens, the coating should be applied to the 19.05-mm (0.75-in.) diameter face only (see Fig. 3).

8.3.2.2 For the bending fatigue specimens, the coating should be applied to the reduced section only, with the exception of the constant stress specimen which should have coating in the entire region of constant stress (see Figs. 5-9).

8.3.3 All thermal treatments normally performed on the devices should be performed on the test specimens.

8.3.4 If used, passivation and sterilization techniques should be consistent with those used for actual devices.

8.3.5 *Inspection*—Before testing, visual inspections should be performed on 100 % of the test specimens. Nonuniform coating density shall be cause for specimen rejection. For the shear fatigue specimen, lack of coating on the coated face shall be cause for specimen rejection. For the bending fatigue specimen, lack of coating in highly stressed regions shall be cause for specimen rejection.

9. Procedure

9.1 The number of specimens required for testing, as well as the test methods in which the fatigue data may be interpreted,

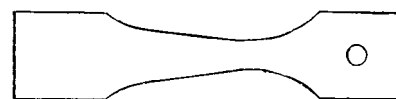

FIG. 9 Tapered Beam Configuration for Bend Testing

can vary. Several test methods are referenced in this test method.^{5,6,7}

9.2 The type of specimen used will depend upon the objective of the test program, the type of equipment available, the equipment capacity, and the form in which the material is available. The specimen chosen should come as close to matching the intended application as possible.

9.3 The test frequency used shall not exceed 170 Hz.

9.4 *Shear Fatigue Specimens:*

9.4.1 *Curing the Adhesive*—The test results achieved are greatly dependent upon the adhesive used and the way in which it is cured. One suggested adhesive is FM 1000 having a thickness of 0.25 mm (0.01 in.). This material has successfully been cured using the following cycle:

9.4.1.1 Align the adhesive with the surface of the coating, taking precautions to align the adhesive in the center of the coating.

9.4.1.2 Apply a constant force using a calibrated high temperature spring, resulting in a stress of 0.138 MPa (20 psi) between the coating and the opposing device that will test the coating.

9.4.1.2.1 Care must be taken to maintain alignment of the coating and the matching counterface during the test.

9.4.1.3 Place the assembly in an oven and heat at 176°C for 2 to 3 h.

9.4.1.3.1 The exact amount of time necessary to cure the adhesive will need to be determined by each user, as oven temperature may vary with load size and oven type. It is suggested that the curing cycle be optimized first without the coating present.

9.4.1.4 Remove the cured assembly from the oven and allow it to cool to room temperature.

9.4.1.5 Remove all excess adhesive which has protruded from the coated surface. This process must not compromise the integrity of the sample.

9.4.2 Place the specimen assembly in the grips so that the long axis of the specimen is perpendicular to the direction of the applied shear load through the centerline of the grip assembly (see Fig. 3).

9.4.3 Specimens for which the adhesive has penetrated to the substrate shall be discarded and the results not included in the analysis and report.

9.5 *Bending Fatigue Specimens:*

9.5.1 Appropriate testing of the uncoated substrate material, upon which the coating will be applied, should be performed to establish a baseline from which to assess the effect of the coating.

9.5.1.1 The baseline test specimens may or may not be grit-blasted depending upon the objective of the test. In either event, the surface roughness should be reported.

9.5.1.2 For composite calcium phosphate-metallic coatings, additional baseline testing of specimens with only the metallic coating should also be performed to allow an assessment of the

effects of each coating.

9.5.2 When mounting the specimen, alignment is crucial. Factors such as poorly machined specimens and misalignment of machine parts might result in excessive vibration leading to erroneous results.

9.5.3 For the rotating beam test, do not apply the load until the machine is operating at the frequency desired for testing.

9.5.4 For the purpose of calculating the applied loads on the test specimen, to determine the applied stresses, measure the dimensions from which the substrate area is calculated to the nearest 0.03 mm (0.001 in.) for dimensions equal to or greater than 5.08 mm (0.200 in.) and to the nearest 0.013 mm (0.0005 in.) for dimensions less than 5.08 mm (0.002 in.).

9.5.4.1 For the coated specimens, the uncoated substrate dimensions should be used to calculate the applied stress.

9.5.5 Any fracture which occurs outside the gage section shall be rejected.

10. Test Termination

10.1 Continue the testing until the specimen fails or until a predetermined number of cycles has been reached (typically 10^7 cycles). Failure may be defined as: (1) complete separation of the coating, (2) visible cracking at a specified magnification, (3) a crack of certain dimensions, (4) or by some other criterion.

11. Stress Calculation

11.1 *Shear Fatigue Specimens*—Calculate the substrate area upon which the coating is applied to the nearest 0.06 cm^2 (0.01 in.^2). Record peak (failure) load and calculate failing stress in megapascals (pound-force per square inch) of adhesive area as follows:

Adhesion or cohesion strength = maximum load/cross-sectional area

11.2 *Bending Fatigue Specimens*—For the purpose of calculating the applied loads on the test specimen to determine the applied stresses, measure the dimensions from which the substrate adhesive area is calculated to the nearest 0.03 mm (0.001 in.) for dimensions equal to or greater than 5.08 mm (0.200 in.) and to the nearest 0.013 mm (0.0005 in.) for dimensions less than 5.08 mm (0.002 in.).

12. Report

12.1 The test report procedure and results shall be in accordance with Practice E 468 and include the following information:

12.1.1 Identification of the materials used in the specimen, including bonding agent used,

12.1.2 Identification of methods used to apply the coating including the coating method, heat treatment, or other data if available including date, cycle number, and time and temperature of run,

12.1.3 Dimensional data including the bond cross-sectional area and the thickness of the coating,

12.1.4 Number of specimens tested,

12.1.5 All values for the applied stress and cycles to failure (or run-out),

12.1.6 The mode and location of failure (for example, cohesive versus adhesive) for each test specimen. (This may

⁵ Collins, J.A., *Failure of Materials in Mechanical Design*, John Wiley & Sons, New York, 1981.

⁶ *Handbook of Fatigue Testing*, ASTM STP 566, ASTM, 1974.

⁷ Frost, N. C., Marsh, K. J., and Pook, C. P., *Metal Fatigue*, Oxford University Press, London, 1974.

also be performed at various intervals during the test.),

12.1.7 The criteria selected for failure, including the number of cycles chosen for run-out,

12.1.8 Report the *R* ratio (minimum stress/maximum stress),

12.1.9 The test frequency,

12.1.10 The specimen size for the shear fatigue test if different than the standard size,

12.1.11 The substrate surface roughness for the baseline bending fatigue test, and

12.1.12 Location of the fracture.

13. Precision and Bias

13.1 *Review of the Round Robin*—Six laboratories were involved in round-robin testing. Each laboratory was provided with 12 Ti-6Al-4V rotating beam specimens coated with plasma-sprayed titanium. Specimens were tested at 90 000 psi.

13.2 Table 1 shows the cycles to failure raw data generated from each laboratory.

13.3 *h Graph*:

13.3.1 The *h* value evaluates the consistency of the test results from laboratory to laboratory.

13.3.2 There are three patterns in these plots. In one pattern, all values are either positive or negative. In the second pattern, there are roughly the same number of laboratories that exhibit

positive values as those that exhibit negative values. In the third type, one laboratory exhibits a value that is opposite of the other laboratories. The first two types are considered normal. The third type warrants further evaluation.

13.3.3 Fig. 10 shows the *h* values for each laboratory.

13.4 The *k* value evaluates the consistency of the test results within each laboratory.

13.4.1 *k Graph*:

13.4.1.1 The *k* value evaluates the consistency of the test results within each laboratory.

13.4.1.2 The pattern to look for in the *k* graph is a laboratory having a very large or a very small *k* value. High values indicate imprecision. Very small values indicate a very insensitive measurement scale or other measurement problems. A *k* value greater than 1 indicates greater variability than other laboratories.

13.4.1.3 Fig. 11 shows the *k* values for each laboratory.

13.5 *Precision Statistics*—The precision statistics are shown in Table 2.

14. Keywords

14.1 ceramic coatings; composite coatings; fatigue testing; hydroxylapatite; metallic coatings; plasma-sprayed coatings; porous coatings; tribasic calcium phosphate

TABLE 1 ASTM F 1160 Round Robin, Cycles to Failure

Source ^A	1	2	3	4	5	6
	83 300	78 000	run out	64 700	64 200	71 900
	53 500	62 300	26 800	78 800	136 300	51 000
	80 400	92 200	16 900	137 200	57 000	88 100
	67 900	36 300	28 700	175 100	48 700	51 200
	64 900	73 400	17 900	116 400	32 100	58 200
	89 400	98 200	70 700	211 100	61 300	42 400
	51 000	49 100	52 900	183 100	45 100	58 400
	72 500	63 600	22 500	200 500	77 900	84 200
	46 600	118 200	23 300	161 200	40 000	64 600
	54 800	40 700	38 000	111 100	55 400	44 800
	48 100	82 800	36 800	277 500	38 100	73 300
	97 700	72 700	...	183 100	56 800	66 400
Average	67 517 ± 17 277	72 292 ± 22 009	33 450 ± 11 622	158 317 ± 60 157	59 408 ± 27 312	62 875 ± 14 653

^A1 = Biomet.
 2 = Osteonics.
 3 = Wright Medical.
 4 = EML.
 5 = Zimmer.
 6 = Howmedica.

h Values
(h Critical = 1.92)

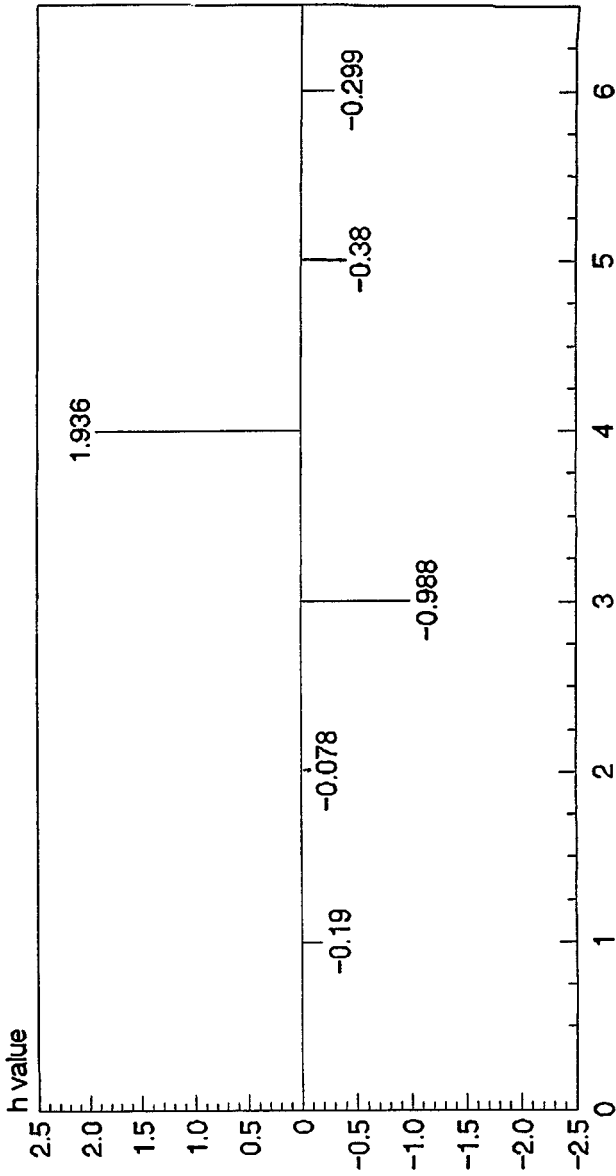

FIG. 10 h Values

k Values
(k Critical = 1.49)

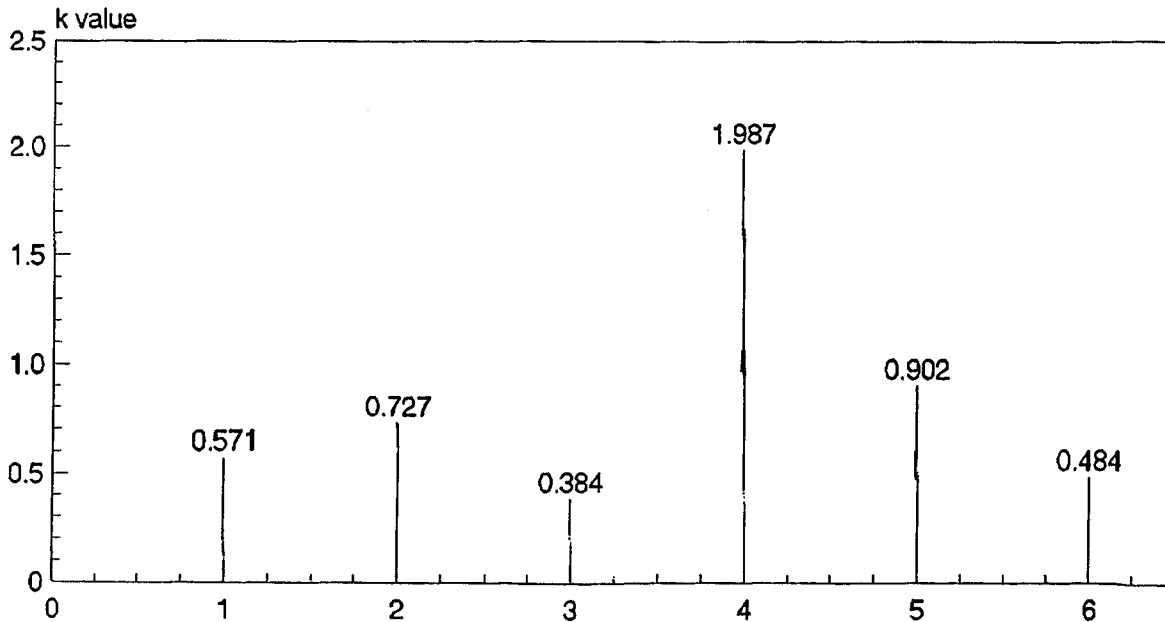

FIG. 11 k Values

TABLE 2 Precision Statistics

X^A	S_x^B	S_r^C	S_R^D	r^E	R^F
75 643	42 706	30 269	51 611	84 753	144 511

^A X = average of the cell averages.
^B S_x = standard deviation of cell averages.
^C S_r = reproducibility standard deviation.
^D S_R = repeatability standard deviation.
^E r = 95 % repeatability limit.
^F R = 95 % reproducibility limit.

APPENDIX

(Nonmandatory Information)

X1. RATIONALE

X1.1 These test methods are needed to aid in the development of a high-quality material for use in load-bearing implant applications. The influence of coatings on the resulting fatigue behavior of the system must be viewed as a combination of the surface-roughening treatments required to apply the coating,

the thermal effects of the coating process, and any other secondary treatments used. The purpose of this specification is to provide the following information: (1) the influence of the preceding processing steps and (2) the integrity of the coating and the coating/substrate interface.

The American Society for Testing and Materials takes no position respecting the validity of any patent rights asserted in connection with any item mentioned in this standard. Users of this standard are expressly advised that determination of the validity of any such patent rights, and the risk of infringement of such rights, are entirely their own responsibility.

This standard is subject to revision at any time by the responsible technical committee and must be reviewed every five years and if not revised, either reapproved or withdrawn. Your comments are invited either for revision of this standard or for additional standards and should be addressed to ASTM Headquarters. Your comments will receive careful consideration at a meeting of the responsible technical committee, which you may attend. If you feel that your comments have not received a fair hearing you should make your views known to the ASTM Committee on Standards, at the address shown below.

This standard is copyrighted by ASTM, 100 Barr Harbor Drive, PO Box C700, West Conshohocken, PA 19428-2959, United States. Individual reprints (single or multiple copies) of this standard may be obtained by contacting ASTM at the above address or at 610-832-9585 (phone), 610-832-9555 (fax), or service@astm.org (e-mail); or through the ASTM website (www.astm.org).