

UIC Code

580

OR

6th edition, 1.1.90

Inscriptions and markings, route indicators and number plates to be affixed to coaching stock used in international traffic

**NUMERISATION DANS  
L'ETAT DU DOCUMENT**

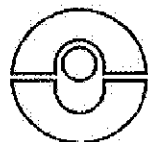

International Union of Railways

580

- 2 -

OR

Leaflet to be classified in volumes:

IV - Operating

V - Transport stock

Amendments

1. 1.7.90.....	.....
2. 1.1.91.....	.....
3. 1.1.94.....	.....
.....	.....
.....	.....
.....	.....
.....	.....

Preliminary remarks:

Obligatory provisions are preceded with an asterisk: \*

A double vertical line (||) in the margin denotes modifications introduced on the date shown at the foot of the page.

Enforcement of this Leaflet is governed by the provisions listed under "Application" at the end of the document.

**Note**

This leaflet is part of a set which also includes :

- Leaflet 413 : Measures to facilitate travel by rail.
- Leaflet 438-1 : Uniform numerical marking of hauled passenger stock.
- Leaflet 440 : Loudspeaker systems in RIC coaches.
- Leaflet 541-1 : Brakes — Regulations concerning the construction of various brake components.
- Leaflet 541-3 : Brakes — Disc brakes and disc brake linings.
- Leaflet 545 : Brakes — Inscriptions, marks and signs.
- Leaflet 552 : Electric power supply for trains taken from the train cable.
- Leaflet 560 : Doors, entrance platforms, windows, steps, handles and handrails of coaches and luggage vans.
- Leaflet 563 : Fittings provided in coaches in the interests of hygiene and cleanliness.
- Leaflet 567-1 : Standard X- and Y-type coaches accepted for running on international services — Characteristics.
- Leaflet 567-2 : Standard Z-type coaches accepted for running in international traffic — Characteristics.
- Leaflet 640 : Motive power units. Inscriptions, marks and signs.

**Contents**

- 0 - General.
- 1 - Outside and inside inscriptions, markings and pictograms.
- 2 - Route indicators.
- 3 - Number plates.
- 4 - Other information holders.
- 5 - Seat markings.
- Appendix 1 - Inscriptions and markings, route indicators and number plates.
- Appendix 2 - Arrangement of staff information and passenger service information on the vehicle.
- Appendix 3/3a - Information strip — Permanent passenger information on the vehicle ends.
- Appendix 4 - Outside route indicator and suspension hook.
- Appendix 5 - Outside route indicator.
- Appendix 6 - Frame for inside route indicator and number plate.
- Appendix 7 - Inside route indicator.
- Appendix 8 - Outside number plate — Inside number plate — Plate holder.
- Appendix 9 - Outside sundry signs and inscriptions.
- Appendix 10 - Brake signs and inscriptions.
- Appendix 11 - Sign denoting last overhaul.

Appendix 12 - Warning sign.

Appendix 13 - Sign for vehicles equipped with an electropneumatic door closing system and remote control of lighting.

Appendix 14 - Seat reservation frame.

Appendix 15 - Seat numbering in coaches — Arrangement and numbering in smoker and non-smoker compartments.

Appendix 16 - RIC frame.

### 0 - General

The conditions of this leaflet shall apply to all :

- coaching stock, including sleeping-cars, dining cars, saloon coaches and ambulance coaches,
- luggage and mail vans,
- vans for the carriage of motor vehicles,
- railcars for the carriage of passengers, used in international traffic.

These various vehicles shall henceforth be referred to as "coaching stock".

\* 0.1 - Coaching stock must carry information items for the benefit of both staff and passengers. This leaflet defines the nature and position of standard inscriptions and markings, route indicators and number plates.

0.2 - Passenger information items displayed inside and outside coaches shall be divided into three categories as follows :

\* 0.2.1 - Information covering emergency situations.

\* 0.2.2 - Information concerning the use of the coach and its facilities (of primary importance).

0.2.3 - Information concerning services provided on the train and special features on the vehicles (of secondary importance).

\* 0.3 - The manner in which information is displayed inside and outside coaching stock shall depend on its importance.

\* 0.4 - Information covering emergency situations must be displayed very clearly next to the danger area or to the safety devices.

\* 0.5 - The structure and the colour of the information items in these three categories must blend together to form a harmonious unit.

0.6 - It is recommended that inside the coaches information be provided indicating to passengers the direction of the various services available.

\* 0.6.1 - Information on amenities available to passengers and, where appropriate, directions for their use must be integrated into the overall system.

\* 0.7 - Passenger information shall be kept distinct from staff information in terms of visual presentation as well as location.

## 1 - Outside and inside inscriptions, markings and pictograms

\* 1.1 - The nature, dimensions and colour of the inscriptions and markings covering passenger information on the services provided as well as staff instructions, which must be displayed either directly on the vehicles or on plates, are defined in Appendix 1 (1).

Appendices 2, 3 and 3a specify the position of the outside inscriptions and plates to be placed in the same order, from left to right, on both sides of the vehicle..

\* 1.1.1 - The inscriptions and markings shall be placed so that they are visible at all times.

\* 1.1.2 - The inscriptions and markings must not be used on the vehicles with any other meaning.

(1) In the appendices the dimensions are given in millimetres. Dimensions without the designation "min" or "max" are recommended values.

1.2 - Inclusion of any additional information shall be left to the decision by the owner railway.

\*1.2.1 - These additional inscriptions must always be placed some greater distance from the positions for the inscriptions and markings defined in 1.4 and Appendices 1 to 3a.

\* 1.3 - The inscriptions and markings should preferably take the form of UIC pictograms as per UIC Leaflet 413, or be shown in block letters. Pictograms must not be accompanied by explanatory text. When this cannot be avoided, such text must be made to integrate into the overall system.

\* 1.3.1 - Inscriptions and markings defined in section 1.4 must be shown in the language of the owner railway with Latin characters and Arabic numerals.

\* 1.3.2 - Inscriptions defined in section 1.5 must be shown in French and German, in the case of coaches operated in Italy also in Italian, in Latin characters and Arabic numerals.







1.3.2.1 - The addition of text in one or several other language(s) is permitted.

## 1.4 - Outside inscriptions and markings

The following outside inscriptions and markings, as defined in 1.1, must be displayed on the vehicles so that they are clearly visible :

\* 1.4.1 - The sign of the railway owning the vehicle together, if appropriate, with its emblem. Vehicles owned by non-railway companies or enterprises must bear the mark of these companies or enterprises.



\* 1.4.2 - The identification marking with the vehicle number in accordance with the regulations of UIC Leaflet 438-1, chapter 4.

- \* 1.4.3 - One of the following  (1) signs according to Appendix 16 :
- the sign  according to Appendix 16, Fig. 1, indicating that the vehicle :
    - complies with the RIC regulations, point 31.1,
    - can run at the maximum speed entered in the box to the left of the  sign ;
  - the sign  according to Appendix 16, Fig. 2, indicating that the vehicle :
    - complies with the RIC regulations, section 31.1,
    - can run at the maximum speed entered in the box to the left of the  sign ;
    - complies with the special conditions of Annex II to RIC of the railways on whose lines the vehicle can run and whose symbol (in accordance with RIC, Annex I) is shown in the box to the right of the  sign. A vehicle not complying with the special conditions of a railway in accordance with RIC, Annex II, will be indicated by the sign \*, in accordance with Appendix 16, Fig. 2, placed aside of the symbol of this railway ;
  - the sign  in accordance with Appendix 16, Fig. 3, to indicate that the vehicle complies with the conditions of UIC Leaflet 569 for crossing on to train ferries on mobile ramps forming an angle of less than or equal to 2°30' with the vertical plane and a track curve radius of 150 m. The inscription shown in the box shall be completed, if appropriate, with the abbreviated description of the ferry routes, in accordance with Fig. 3, with a greater ramp angle and shorter curve radius, on which the vehicle can also be operated.

1.4.3.1 - The sign E, in accordance with Appendix 16, Fig. 4, indicating that the vehicle complies with the conditions of UIC Leaflet 430-2 for running on lines of RENFE and CP.

1.4.3.2 - The vehicles may bear the sign  if they comply with all other conditions required for affixing this sign.

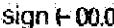
(1) Only member railways of RIC.

- \* 1.4.4 - The tare weight, including 50 % of the water reserve, and the total weight in tonnes and :
- in the case of coaches, the number of seats, according to Appendix 9, Figs.4a or 4b ;
  - in the case of vans and mail vans, the load limit, according to Appendix 9, Fig. 4c ;
  - in the case of coaches with luggage compartment, the number of seats and the load limit, according to Appendix 9, Fig. 4d.
- \* 1.4.5 - For compressed air brakes, the signs and inscriptions according to Appendix 10 and UIC Leaflet 545, Appendices 2, 6, 7 and 8. In addition, the braked weight and the inscriptions as per UIC Leaflet 545, Appendix 3.
- \* 1.4.6 - For vehicles equipped with disc brakes, a display for checking the functioning of the brake according to UIC Leaflet 541-3, point 1.
- \* 1.4.7 - For vehicles equipped with composition brake blocks with a high friction coefficient, the sign  according to UIC Leaflet 545, Appendix 6, on the cover of the box or cabinet holding reserve brake blocks, according to UIC Leaflet 541-1, chapter VII.
- \* 1.4.8 - Indication of the date of the last overhaul, preceded by the service having performed it, using one of the signs according to Figs. 1 or 2 of Appendix 11.
- \* 1.4.9 - For vehicles carrying goods for customs clearance and having several separate compartments, a letter (A, B...) on each compartment, when the vehicles have no side corridor.
- \* 1.4.10 - In respect of the power supply, inscriptions according to UIC Leaflet 552, Plates I and V.
- \* 1.4.11 - The length over buffers of the vehicle by means of using the sign  as per Appendix 9, Fig. 1, the distance between pivots and, on the bogies, the distance between their axles by means of the sign  according to Appendix 9, Fig. 2.

\* 1.4.12 - On all coupler sockets and plugs of the train line as well as for vehicles with entrance steps whose tops are higher than 2000 mm above rail level, or with ladders whose extremities exceed this height, the warning sign  according to Appendix 12 immediately adjacent to these points.

\* 1.4.13 - For vehicles:

- with loudspeaker equipment, the signs provided for in UIC Leaflet 440, Figs. 1, 2, 3 or 4,

- equipped with an electropneumatic door closing system and remote control of lighting, the sign  according to Appendix 13.

\* 1.4.14 - In the entrance area with the hand brake on both vehicle sides on the girder near the entrance door, the pictogram and inscription according to UIC Leaflet 545, point 10.

\* 1.4.15 - To indicate the filling and emptying devices of the water reservoirs and pipes, the signs specified in point 4 of UIC Leaflet 563.

\* 1.4.16 - For privately owned vehicles the sign  according to Appendix 9, Fig. 5, behind the self-check digit (see point 1.4.2).

\* 1.4.17 - For vehicles, which due to their design or equipment may suffer damage, when negotiating shunting humps with a 250 m curve radius, the sign  according to Appendix 9, Fig. 3, with indication of the smallest curve radius which can be negotiated.

\* 1.4.18 - The construction year of the vehicle near the entrance steps or on the girder.

\* 1.4.19 - For marking the emergency signal re-setting device, when it is enclosed in an outside box, the signs according to UIC Leaflet 545, Appendix 4.

\* 1.4.20 - For wheels with fitted tyres, 4 paint strips forming an angle of 90° between strips on the outside of the tyre and rim.

\* 1.4.21 - For pressure sealed vehicles, a "(p)" as per RIC, Plate 11, Fig. 4, in a box adjacent to that used to indicate the loudspeaker installation.

\* 1.4.22 - For vehicles with sealed toilet systems the symbol specified in UIC Leaflet 563, Appendix 18.

**1.5 - Inside inscriptions, markings and pictograms**

The following inscriptions, signs and pictograms shall be affixed inside vehicles:

\*1.5.1 - Designation of the class of travel at eye level in the side corridor on or next to the compartment doors and in each of the entrance vestibules on the wall opposite the intercommunicating door. In composite coaches, the designation of the two classes shall be affixed in each vestibule.

|| \*1.5.1.1 - For centre-aisle coaches, class-of-travel indications shall be displayed at lounge ends.

\* 1.5.2 - The prohibition from leaning out of windows with pictogram as per point 1.5.13 or with the inscription:

"Ne pas se pencher au dehors  
Nicht hinauslehnen  
E pericoloso sporgersi"  
(Do not lean out)

\* 1.5.2.1 - These pictograms or inscriptions shall be affixed either on or near all movable windows out of which people can lean.

\* 1.5.3 - The sign warning passengers against opening the side entrance doors, while the train is moving, as per UIC Leaflet 560, point 1.1.8 (see also point 1.5.13).

\* 1.5.4 - Designation of the end positions of the closures of the side entrance doors of the hinged and hinged folding type as per UIC Leaflet 560, point 1.2.5.2.

\* 1.5.5 - The emergency brake sign (alarm signal) and the warning that unauthorised use carries a penalty in accordance with UIC Leaflet 545, point 5.

|| 1.1.91

\* 1.5.6 - Sign warning against the use of non-sealed WC's when the train is standing at the station:

"L'usage du WC est interdit pendant l'arrêt en gare"

Während des Aufenthaltes auf den Bahnhöfen ist die Benutzung des WC nicht gestattet

Durante le fermate nelle stazioni è vietato servirsi del WC".

(Do not use WC when train is standing at station).

\* 1.5.7 - A letter on each compartment, when the vehicle carrying goods to be customs-cleared has a side corridor and several separate compartments.

\* 1.5.8 - Checklist of accessories:

1.5.8.1 - As far as is possible, the checklist shall be placed inside the electrical equipment control cabinet.

\* 1.5.9 - On the glass cover of the box housing the emergency hammer:

"Marteau brise-vitres

Nothammer

Martello frangivetri"  
(Emergency hammer),

and the marking specified in point 5 of Leaflet 564-1.

\* 1.5.10 - The designation of "smoking" and "non-smoking" compartments using corresponding pictograms (point 1.5.13) visible in the compartment and the corridor.

1.5.10.1 - These pictograms may be supplemented with the inscriptions "Smoking" and "Non-smoking" in one or several languages.

\* 1.5.10.2 - For centre-aisle coaches, "Smoking" and "Non-smoking" inscriptions must be placed at the end of lounges.

\* 1.5.10.3 - The "No smoking" sign must be displayed in all vestibules and side corridors. Where the side corridors are divided up into several sections by means of doors, the sign must be displayed in each of these sections.

\* 1.5.11 - When the emergency brake resetting device is enclosed in a box, this box must bear the sign specified in Leaflet 545, point 5.

\* 1.5.12 - The vehicle number in each entrance vestibule.

\* 1.5.13 - The following pictograms in accordance with Leaflet 413, Appendix 1:

## OR

- No. 12 Toilets  
The railways can use the two general symbol as per No. 12 or the two pictograms No. 13 (Ladies) and No. 14 (Men) side by side,
- No. 70 Non-smokers,
- No. 71 Smokers,
- No. 72 Temperature,
- No. 73 Ventilation switch,
- No. 74 Light switch,
- No. 75 Loudspeaker regulator,
- No. 78 Do not open before the train stops,
- No. 79 Do not lean out,
- No. 80 Do not throw anything out of the window,
- No. 81 Washroom,
- No. 82 For water, operate foot pedal,
- No. 83 Not drinking water,
- No. 84 Socket for electric razor,
- No. 85 Receptacle for used paper towels and waste.

1.5.13.1 - It is recommended also to use the following pictograms:

- No. 21 Direction arrow (e.g. way to dining car or WC),
- No. 22 Disabled persons,
- No. 33 Public telephone,
- No. 34 Restaurant,
- No. 35 Buffet,
- No. 36 Shower,
- No. 76 Seat for disabled persons,
- No. 77 Accompanied small child.

\* 1.5.14 - The signs specified in Leaflet 440, point 5.2, on the doors of the cabinets housing the loudspeaker equipment.

\* 1.5.15 - The sign indicating the emergency door unlocking device, as specified in Leaflet 560, point 3.3.3.

## OR

## 2 - Route indicators

\* 2.1 - All coaches, excluding mail vans, luggage vans and car-carrying trailers, must incorporate suspension hooks for outside route indicators. The upper hooks must conform with the design in Appendix 4, Fig. 1a, and the lower hook with Fig. 1. They must be mounted in accordance with Fig. 2 of the same Appendix.

\* 2.1.1 - The installation of fixed route indicators and number plates is authorised.

\* 2.1.1.1 - Their form and content must correspond to the specifications for detachable plates outlined below and must be easily readable even in bad light conditions.

In such a case, the hooks required for detachable plates may be dispensed with.

\* 2.2 - Where railway owned coaches are concerned, the outside route indicators must conform with the design in Appendix 4, Fig. 3, as regards their shape and dimensions and must be positioned near each right hand entrance door (see Appendix 2), except on sleeping cars and dining cars.

2.3 - As regards coaches running at a maximum speed over 160 km/h, it is recommended that the outside route indicators be housed in recesses.

\* 2.3.1 - In this case the recess dimensions must allow for plates to be inserted in accordance with Appendix 4, Fig. 3. When a frame is used, space must be left vacant for the plate inscription panel as shown in Appendix 5.

\* 2.4 - The instructions contained in points 2.1 to 2.3.1 above shall apply to mail and luggage vans and car-carrying trailers, which are provided with outside route indicators.

\* 2.5 - Outside route indicators must show the originating and destination stations of the train as well as the scheduled itinerary. The originating station shall be indicated on the first line in medium-size print, the next line showing the itinerary in smaller print and the line underneath giving the destination station in medium-size print. Important intermediate stations shall also be shown in medium-size print (see example in Appendix 5).



## OR

2.6 - The name of the originating station may be displayed on the same line as the itinerary.

\* 2.7 - A holding frame for the inside route indicator shall be affixed near the entrance doors in each coach vestibule, as shown in Appendix 6.

\* 2.8 - Inside route indicators shall be designed as shown in Appendix 7.

2.8.1 - The installation of inside fixed route indicators and number plates is authorised.

In such cases, frame mountings may be dispensed with.

\* 2.9 - The text and structure of inside route indicators must be identical with those of the outside route indicators.

2.10 - Whenever possible, the inscriptions on route indicators must follow the text in column 2 of the EWP.

\* 2.11 - The station names must be shown in Latin characters and painted in a contrasting colour, in the language of the country where the stations are located.

\* 2.12 - In cases where the train number and/or name should also be shown, such particulars must be visually distinguished from the itinerary by means of a horizontal line (see example, Appendix 5).

\* 2.13 - As in the case of the originating station, important intermediate stations as well as the destination station, together with the train number and/or name must be distinguished from other indications by the size and type thickness of the text.

\* 2.14 - These indications shall appear, respectively, on successive lines with justification to the left margin. If necessary, the train number may be shown to the front.

## OR

\* 2.15 - Plates must bear the markings of the owner railway and the name of their home station in small print on their upper edge or on the side. The lower edge of the line must be parallel to the respective plate edge.

## 3 - Number plates

\* 3.1 - Coaches, excluding dining cars, must be provided with an outside number plate near each entrance door and an inside number plate near the route indicator.

\* 3.2 - The dimensions of the inside and outside number plates, as well as the inscriptions on them, must conform with Appendix 8.

\* 3.3 - The outside number plates shall be affixed in accordance with the provisions of Appendix 8.

\* 3.3.1 - They must also be visible when the doors are open.

3.4 - Inside number plates must be attached, as far as possible, above the route indicator (see Appendix 6 for recommended mounting).

\* 3.5 - The number plates must bear an inscription with the name of the owner railway in accordance with Appendix 8 (on the front or back).

3.6 - The serial number may be shown on the route indicator.

**4 - Other information holders**

\* 4.1 - An information strip shall be affixed on the outside of the coach indicating, at window level :

- near the entrance doors, or
- when this area is inadequate or likely to be hidden by the doors, between the 1st and 2nd windows,
- the class (1) and type of coach and, where appropriate, the services provided (see Appendices 3 and 3a).

\* 4.2 - The pictograms on the information strip shall conform with the "Routing" system mentioned in UIC Leaflet 413.

\* 4.2.1 - The information strip must not overlap the upper or lower visibility edge of the window (see Appendices 3 and 3a).

\* 4.2.2 - The height of the space reserved for the digit indicating the class of travel, which is shown without contour line in a high position — position 1 — shall be equal to two grid units. The digit in the pictogram layout shall be justified to the left side or placed at the centre. Its width shall depend on the typographical rules for the block font used and on the available area of the information holder.

\* 4.2.3 - All other information items shall be displayed by means of pictograms (except for additional texts) and arranged in positions 2 and 3, depending on their importance.

\* 4.2.4 - In the absence of the class of travel digit, for example in coaches with customer services, position 1 shall remain open or it may be used for the pictogram indicating the service provided.

---

(1) Only for day and couchette coaches.

4.2.5 - To ensure visual distinction between information items of priority and secondary importance, the latter may be restricted to half the space assigned to information of priority importance.

\* 4.2.6 - Information given in the form of lines is justified to the left side. Any other text required is also justified to the left side.

\* 4.2.7 - The colour, in which the information items are painted, depends on the colour of the frame, so as to make them stand out from the background with a contrasting colour.

\* 4.3 - As regards the combination of digits indicating the coach class and pictograms in the information strip, the following sequence — either side by side in lines or below one another in columns — shall be used (see Appendices 3 and 3a) :

\* 4.3.1 - **Position 1** : Coach class digit.

\* 4.3.2 - **Position 2** : Information items (first priority)

1°) "Smoking"/"No smoking" pictograms.

2°) Type of coach :

- compartment/centre aisle coach,
- couchette coach,
- sleeping car,
- dining car, buffet or bar car.

4.3.3 - **Position 3** : Information items (secondary priority)

1°) Customer services :

- passenger secretariat,
- public telephone service,
- conference compartment,
- "Mother and child" compartment,
- "Disabled persons" compartment, etc.

2°) Special coach features :

(air-conditioning, etc.).

\* 4.4 - So as to make it easier for passengers to identify 1st class coaches from a distance, the coaches (1) shall bear a yellow strip on both sides directly beneath the roof.

\* 4.4.1 - This yellow strip, approximately 100 mm wide, shall extend along the whole length of the 1st class compartments and, where possible, 1st class vestibules. On coaches with two classes of accommodation this strip shall run to the centre line of the window post nearest to the 2nd class accommodation.

4.4.2 - In the case of light coloured coaches, it is recommended that this strip be framed or underlined by a dark band approximately 10 mm wide.

4.4.3 - This coloured band may be omitted, if the coach colour or other features clearly indicate that the coach has 1st class accommodation.

## 5 - Seat markings

### 5.1 - Facilities for seat marking

In order to make seat reservations possible, day and couchette coaches must be provided with the following facilities :

\* 5.1.1 - Day coaches with side corridor :

— above each seat : a fixed number plate (2) ;

— in the corridor at the side of each compartment :

seat reservation frames with a sufficient number of boxes for inserting seat reservation labels with a size of 32 X 105 mm for all seats.

(1) Only for day and couchette coaches.

(2) Day coaches built before 1st January 1971 may be equipped with adjustable seat reservation plates bearing an even or odd seat number. In this case the plates must be arranged in accordance with the seat numbering plan of Appendix 15.

\* 5.1.2 - Day coaches with centre aisles

- above each seat: an individual reservation "holder" bearing a fixed number, into which the reservation label, 32 x 105 mm, can be inserted.

#### 5.1.2.1 - Permitted exemptions

The fixed number may also be separated from the frame; furthermore, the fixed number and the individual reservation holder may also be attached separately from the seats on the side walls of the coach or on the longitudinal rail of the luggage rack; as an exception, coaches with adjustable seats may be equipped with permutable numbers.

\* 5.1.3 - Couchette coaches

- above each seat: a plate bearing a fixed number,

- in each side corridor at the side of each compartment: a reservation frame matching number of seats (1), into which the reservation labels, 32 X 105 mm can be inserted.

\* 5.1.4 - A system to indicate seat reservations must either be fixed above each seat or to the seat itself.

\* 5.2 - Seat numbering - Division between "smoking" and "non-smoking" compartments.

\* 5.2.1 - The seats shall be numbered in accordance with Appendix 15.

\* 5.2.2 - "Smoking" and "non-smoking" compartments shall be divided in the following proportions:

(1) In coaches built before 1 January 1972, reservation frames may be adapted to the number of couchettes available.

OR

Coaches with:

Number of compartments  
"non-smoking" "smoking"

- 12	compartments	8	4
- 11	compartments	7	4
- 10	compartments	7	3
- 9	compartments	6	3
- 8	compartments	6	2
- 7	compartments	5	2
- 6	compartments	4	2
- 5	compartments	3	2
- 4	compartments	2	2
- 3	compartments	2	1
- 2	compartments	1	1

\* 5.2.2.1 - For mixed 1st and 2nd class coaches, this division shall be applied separately for each of the two classes.

\* 5.2.3 - The arrangement and numbering of "smoking" and "non-smoking" compartments in A10, A9, B12, B11, B10, A5B6, A4B6 and A4B5 coaches must conform with the diagram shown in Appendix 15.

\* 5.2.3.1 - It is recommended that the Railways adopt the concept of this diagram for the arrangement and numbering of "smoking" and "non-smoking" compartments in those coaches with a greater number of compartments than the coaches mentioned above.

5.2.4 - The provisions of points 5.2.2 to 5.2.3.1 shall also apply, as far as possible, to centre-aisle coaches.

Annexes — Anlagen — Appendices

## Inscriptions and markings, route indicators and number plates

Reference No.	Description of inscriptions and markings (See also the RIC regulations, § 34 and 51)	Dimensions of the characters (in mm)	Colour to be used for inscription (2)
1	Identification letters of owner of coaching stock (railway or otherwise)	optional	white to yellow
2	Type indication (1)	80 min.	"
3	Vehicle number	80 min.	"
4	Tare, total mass, number of seats provided and load limit for luggage vans and mail vans	35 min.	"
5	RIC mark and energy supply characteristics	90 (RIC mark)	"
6	Pictogram and inscription of brake-weight obtained with hand brake	35 min.	dark on light background
7	Mark denoting vehicles with loudspeaker equipment, an electro-pneumatic door-closing device and remote control of lighting	in accordance with RIC	white to yellow
8	Mark of last overhaul	35 min.	"
9	Length over buffers, distance between bogie pivots and, on bogies, distance between their axles	35 min.	"
10	Braking inscriptions and markings	35 min.	white to yellow and red
11	Mark for vehicles fitted with R brake	in accordance with Lf. 545	white to yellow

12	Space for national markings specific to braking (1)	35 min.	white to yellow and red
13	Home station of vehicle (1)	Name of home station : 35 min. The words "Home station" : 20	contrasting colour
14	Box for label		box in surround painted in a colour contrasting with vehicle colour scheme
15	Indication of jacking point for lifting (1)	Sides of triangle : 25 to 30 ; bar : 80 X 10	white to yellow
16	Year of construction of the vehicle (3)		
17	MC mark (OSJD Member-Railways only)	80 min.	white to yellow
18	Sign for pressure-tight vehicles	50 min.	white to yellow
19	Outside route indicator	Essential indications : 35 min. Intermediate station : 20 min.	in a dark colour on a white background
20	Outside number plate	See Appendix 8	red on white background
21	For coaching stock : indication of class of travel	See Point 4.2.2	See Point 4.2.7
22	Pictograms and any permanent written passenger information on the information strip	Box interior : 150 X 150 min. Additional text : 2 basic units min.	See Point 4.2.7
23	Strip for identifying 1st class	Width : 100 approximately	in the yellow spectrum-band
24	Sign for retention toilet	In accordance with Leaflet 563	contrasting colour
25	Sign for privately - owned coach	35 min.	white to yellow

(1) Non-obligatory inscription.

(2) Where inscriptions are shown on a light background, a contrasting colour shall be used.

(3) The year of construction must be shown on the name plate of the vehicle manufacturer.

**Disposition sur le véhicule des instructions pour le personnel et des informations des services offerts aux voyageurs**  
**Anordnung der dienstlichen und kundendienstlichen Informationen am Wagen**  
**Arrangement of staff information and passenger service information on vehicles**

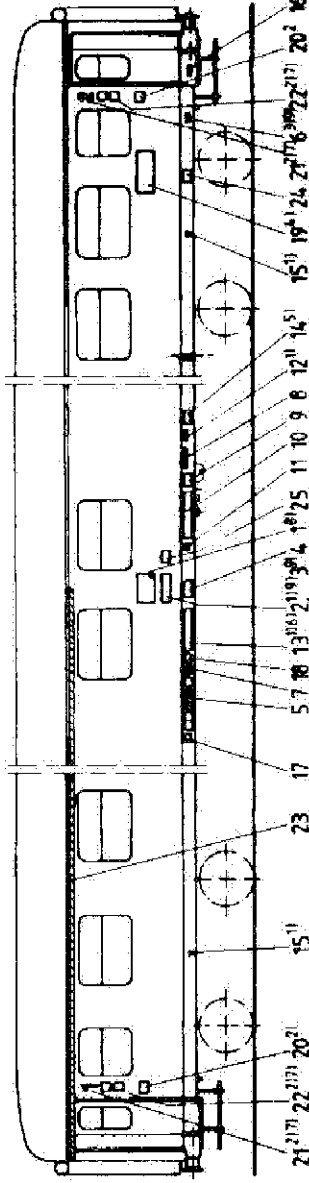

(Nos 1 à 25 : voir Annexe 1 - Die laufenden Nummern 1 bis 25 : siehe Anlage 1 - Nos 1 to 25 : see Appendix 1)

**Exemples des caractères (lettres et chiffres) à utiliser**  
**Schriftbeispiele für die zu verwendenden Buchstaben und Zahlen**  
**Examples of the characters (letters and figures) to be used**



Les inscriptions et marques sont à appliquer dans le même ordre, de gauche à droite, sur chaque face du véhicule.  
Die Anschriften und Zeichen sind auf jeder Wagenseite in der gleichen Reihenfolge von links nach rechts anzubringen.  
The inscriptions and markings shall be applied in the same sequence, from left to right, on each side of the vehicle.

1) Inscription non obligatoire.  
Diese Anschrift ist nicht bindend.  
This inscription is not obligatory.

2) Il est également admis de placer cette inscription au même niveau, entre la 1<sup>ère</sup> et 2<sup>ème</sup> baie. Lorsque le niveau inférieur de la première baie est supérieur à celui des autres baies et que la place entre ladite baie et la porte d'accès est insuffisante, la place de numérotation peut aussi être placée au-dessus de la plaque d'itinéraire.

Es ist auch zulässig, diese Anschrift in gleicher Höhe zwischen dem 1. und 2. Fenster anzubringen. Das Nummernschild kann auch über dem Wagenlaufschild angebracht werden, wenn die Unterkante des ersten Fensters höher liegt als die der übrigen Fenster und der Platz zwischen dem Fenster und der Einstiegstür zu schmal ist.

This inscription may also be placed at the same height between the first and second window. Where the bottom edge of the first window is higher than those of the other windows and the space between the window and the access door is insufficient, the number plate may also be located above the destination board.

3) Cette inscription à apposer côté frein à main, peut être légèrement déplacée pour assurer à tout moment sa visibilité.

Diese Anschrift ist am Handbremsende anzubringen, sie kann geringfügig versetzt sein, um jederzeit sichtbar zu bleiben.

This inscription to be placed at the end of the handbrake; it may be slightly offset to remain visible at all times.

4) Emplacement recommandé.  
Diese Anbringungsstelle wird empfohlen.  
This position is merely recommended.

5) Dimensions :  
— hauteur minimum : 160 mm  
— longueur minimum : 250 mm.  
Abmessungen :  
— Höhe mindestens : 160 mm  
— Länge mindestens : 250 mm  
Dimensionen :  
— min. height : 160 mm  
— min. length : 250 mm.

6) Réserver l'emplacement nécessaire pour une 2<sup>ème</sup> inscription en cas de préférence.

Für den Fall der zehweisen Abgabe des Wagens genügend Platz für 2. Anschrift vorsehen.

Necessary space to be reserved for second inscription in the event of vehicle being on temporary loan.

7) Réalisation voir Annexe 3.  
Ausführung siehe Anlage 3.

See appendix 3 for layout.

8) Il est admis d'apposer cette inscription à un autre emplacement de la face du véhicule.

Es ist zulässig, diese Anschrift an anderer Stelle der Fahrzeugseite anzubringen.

This inscription may be placed at another position on the side of the vehicle.

9) Il est admis d'apposer cette inscription sur la face du véhicule, à gauche devant le carrouche RIC.

Es ist zulässig, diese Anschrift links vor dem RIC-Raster an der Fahrzeugseite anzubringen.

This inscription may be placed to the left of the RIC-Label Clip on the side of the vehicle.

Bande d'informations : Informations clients permanentes à l'extrémité de la  
voiture  
Informationsband : Feste kundendienstliche Informationen am Wagenende  
Information strip : Permanent passenger information on the vehicle ends

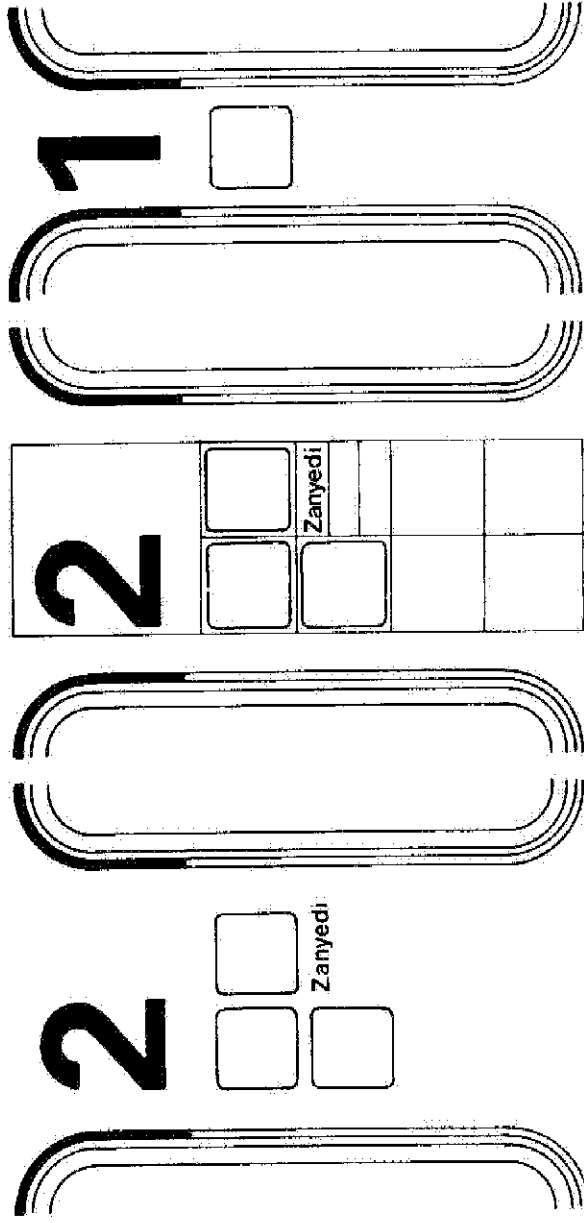

Bande d'informations : Informations clients permanentes à l'extrémité de la  
voiture  
Informationsband : Feste kundendienstliche Informationen am Wagenende  
Information strip : Permanent passenger information on the vehicle ends

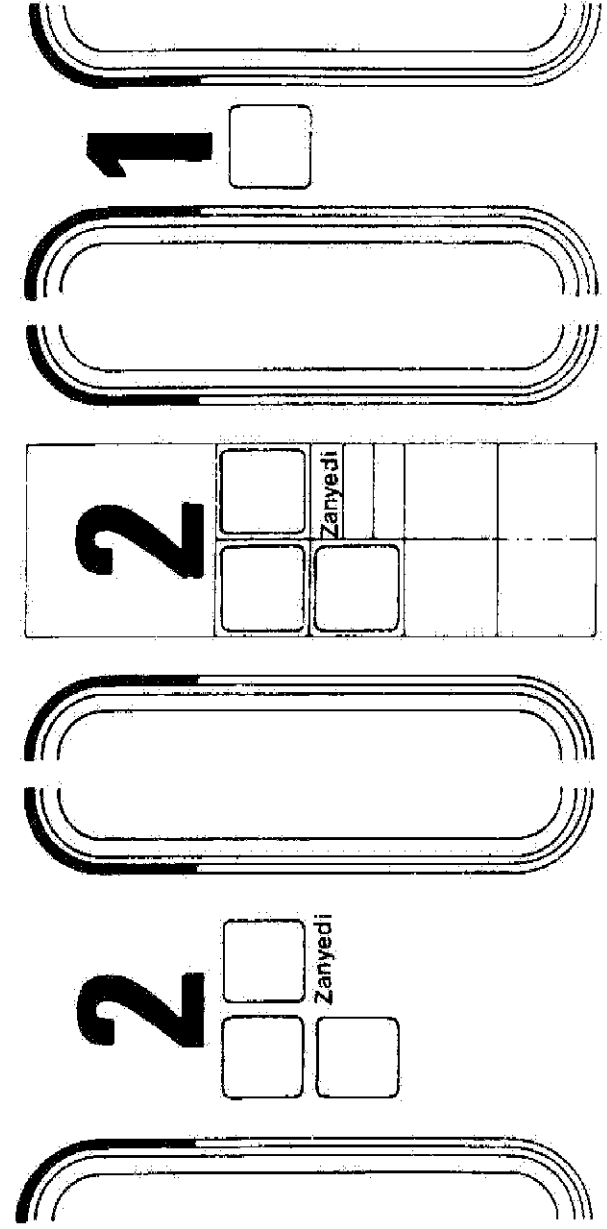

ANNEXE 4  
ANLAGE 4  
APPENDIX 4

Plaque d'itinéraire extérieure et crochet de suspension  
Outside route indicator

Fig. 1  
Bild. 1  
Fig. 1

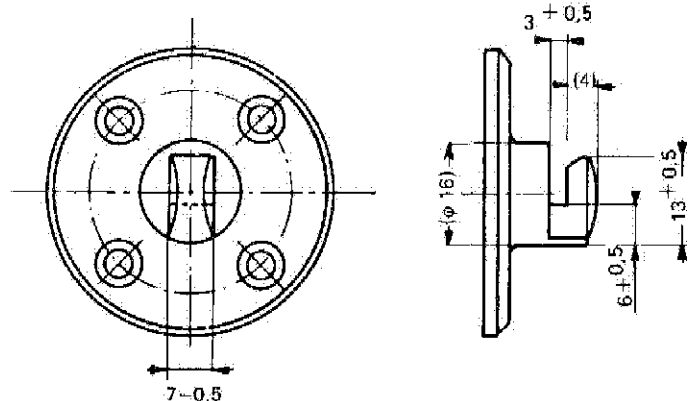
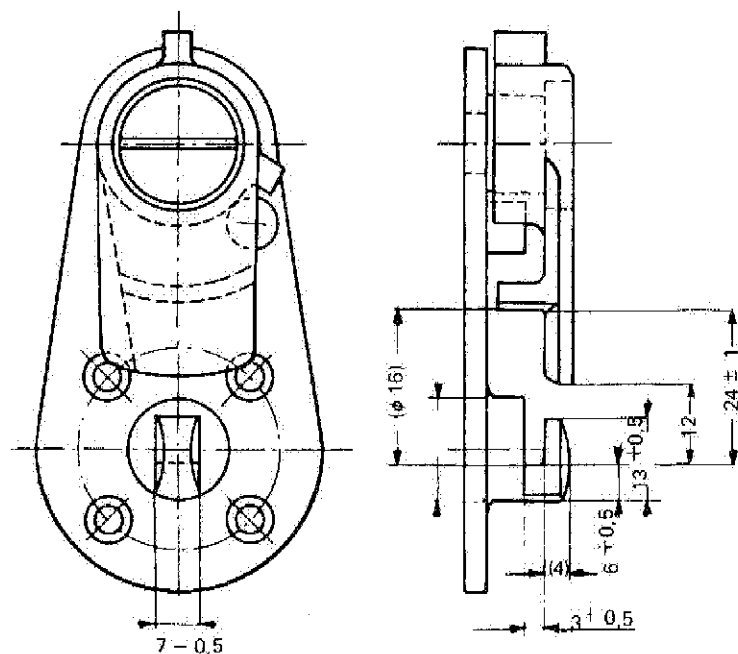

Fig. 1a  
Bild. 1a  
Fig. 1a



ANNEXE 4  
ANLAGE 4  
APPENDIX 4

Äußeres Wagenlaufschild und Haken  
and suspension hook

Fig. 2 - Distance entre les crochets

Bild. 2 - Abstand der Haken

Fig. 2 - Distance between hooks

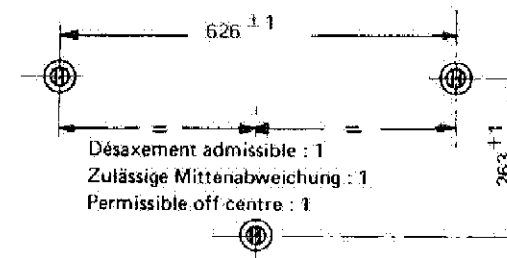
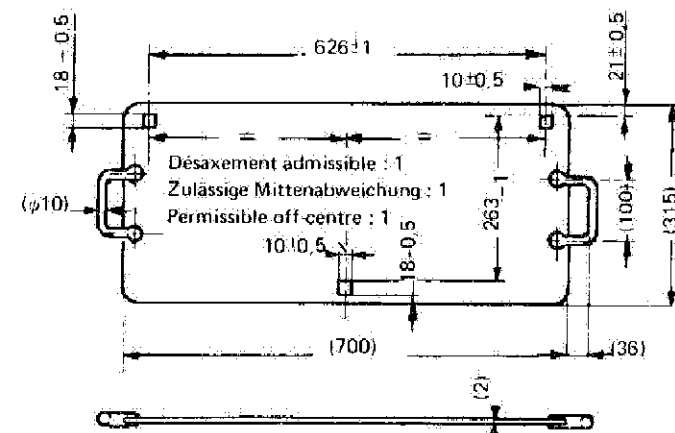

Fig. 3 - Plaque d'itinéraire

Bild. 3 - Wagenlaufschild

Fig. 3 - Route indicator



Les cotes entre parenthèses sont fixées à titre indicatif  
Die Maße in Klammern sind nur nachrichtlich angegeben  
The measurements shown in brackets are given for reference purpose



Plaque d'itinéraire extérieure — Äußeres Wagenlaufschild  
Outside route indicator

Exemples de dispositions de lignes et de lettres  
Beispiele für Zeilen- und Buchstabenanordnung  
Examples for line and letter layout

**D 217 Austria Express**

**Amsterdam CS-**

Utrecht CS - Arnhem - Nijmegen - Krefeld - Köln - Bonn -  
Mainz - Mannheim - Heidelberg - Stuttgart -

**München - Salzburg - Badgastein - Villach -  
Klagenfurt**

NS Amsterdam CS

**Amsterdam CS-  
Paris**

NS Amsterdam CS

Les hauteurs des caractères et les écarts entre lignes et entre les différentes lettres sont fonction des règles typographiques de l'écriture linéale (antique) utilisée et de la surface disponible du porte-informations.

Die Größen und Abstände der Zeilen und einzelnen Buchstaben richten sich nach den typografischen Richtlinien der verwendeten Grotteskschrift (serifenlose Linear-Antiqua) und der verfügbaren Fläche des Informationsträgers.

The size of the characters, the line spacing and the letter spacing depend on the typographical rules pertaining to the "grotesque" type of writing used (doric letters without serifs) and on the available space on the information carrier.

ANNEXE 6  
ANLAGE 6  
APPENDIX 6

Cadre pour plaques intérieures d'itinéraire et de numérotation  
Frame for inside route

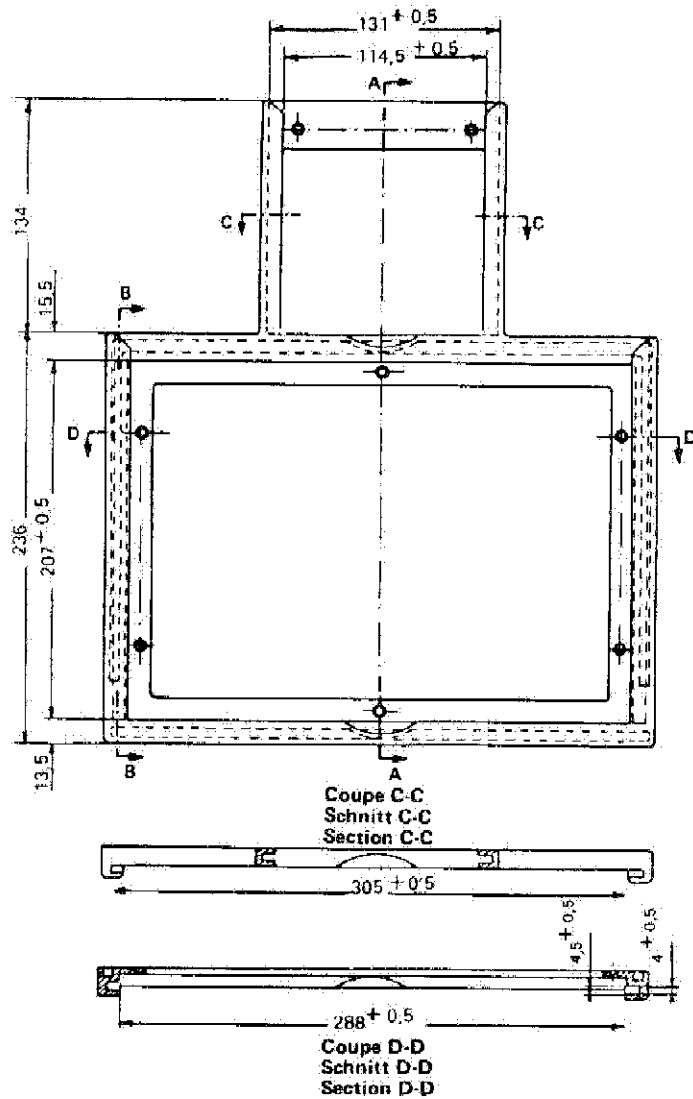

ANNEXE 6  
ANLAGE 6  
APPENDIX 6

Rahmen für inneres Wagenlauf -und Nummernschild  
indicator and number plate

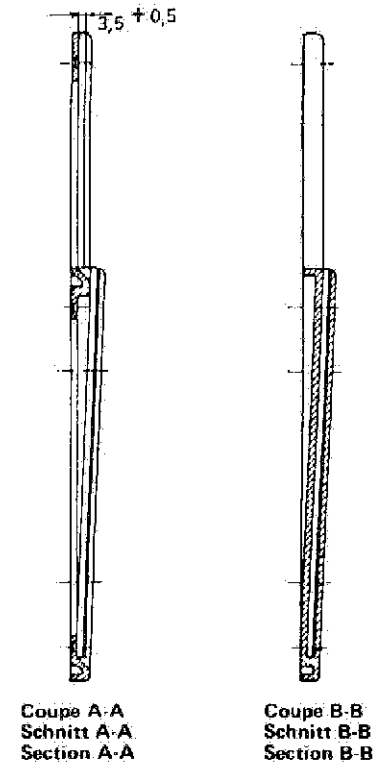

Plaque d'itinéraire intérieure  
Inneres Wagenlaufschild  
Inside route indicator

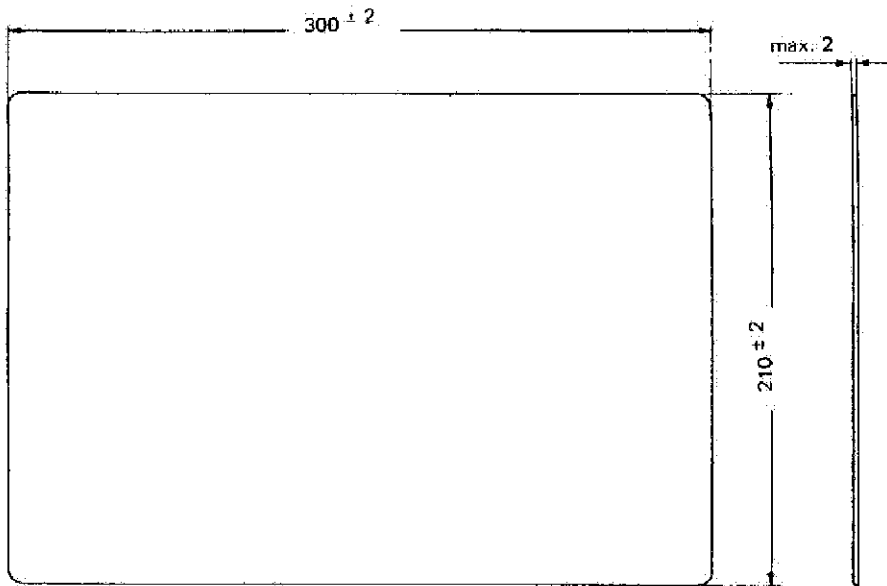

Fig. 1 - Plaque de numérotation extérieure - Nummernschild  
Bild 1

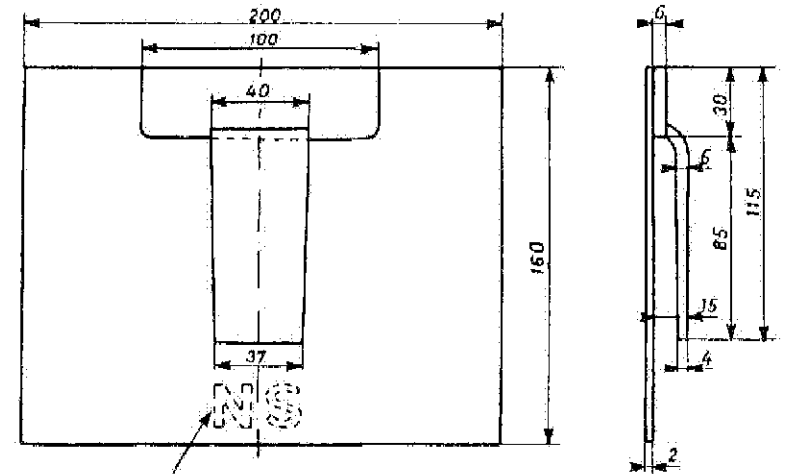
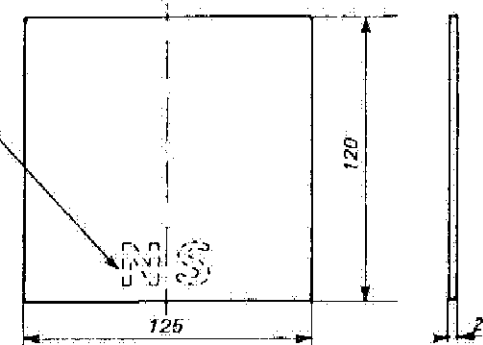

Fig. 2 - Plaque de numérotation intérieure  
Bild 2 - Nummernschild innen

Fig. 2 - Inside number plate

Marque de propriété  
Eigentumsmerkmal  
Owner's mark



Außen -- Outside number plate

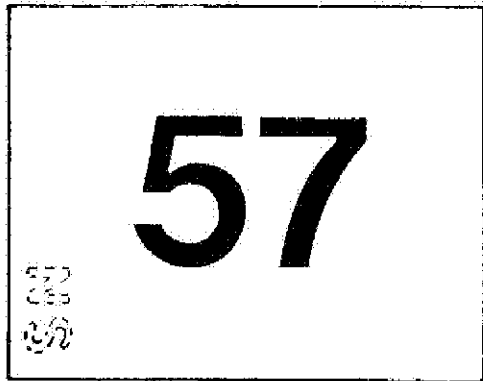
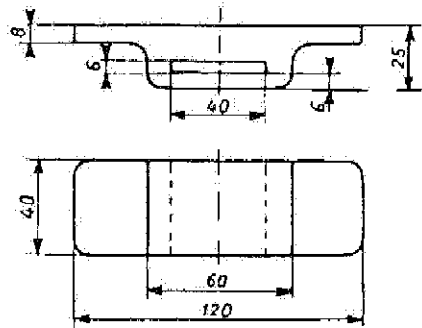

Fig. 3 - Porte-plaque  
Bild 3 - Schildhalter

Fig. 3 - Plate holder

Seulement pour plaque extérieure -- Nur für Außenschild --  
Outside plate only



Divers signes et inscriptions extérieurs -- Diverse Zeichen

Fig. 1  
Bild 1

Signe pour la longueur hors tampons.  
Zeichen für Länge über Puffer.  
Sign for length over buffers.

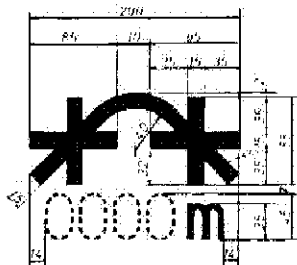

Fig. 2  
Bild 2

Signe pour la distance entre les pivots et pour  
l'écartement des essieux des bogies.  
Zeichen für Drehzapfenabstand und Drehgestell-  
achsstand.  
Bogie sign denoting pivot pitch and wheel base.



## und Anschriften außen -- Outside sundry signs and inscriptions

Fig. } 3  
Bild }

Défense de passer sur des bosses de triage dont le rayon du raccordement est inférieur à celui sous le signe ci-contre.

Befahren von Ablaufbergen mit einem geringeren als unter dem Zeichen angegebenen Aus- bzw. Abrundungshalbmesser verboten.

Not to be shunted over yard humps with smaller transition curve than that depicted in the sign opposite.

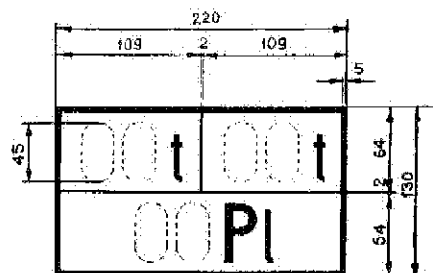
Fig. } 4a  
Bild }

Signe indiquant, pour les voitures d'une seule classe :

- la tare, y compris 50 % de la réserve d'eau (à gauche),
- la masse totale,
- le nombre de places assises.

Bei Personenwagen mit einer Wagenklasse, Zeichen für :

- Eigengewicht, einschließlich 50 % Wasservorrat (links),
- Gesamtgewicht,
- Anzahl der Sitzplätze.

Sign denoting, for uniclass coaches :

- the tare weight including 50 % of the water reserve (on left side)
- the total weight,
- the number of seats.

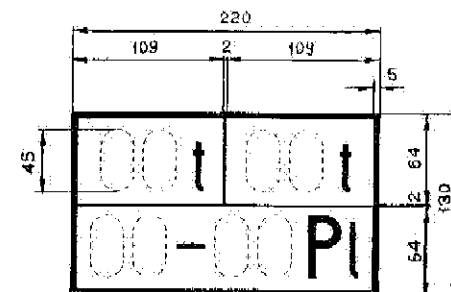
Fig. } 4b  
Bild }

Signe indiquant, pour les voitures ayant deux classes :

- la tare, y compris 50 % de la réserve d'eau (à gauche),
- la masse totale,
- le nombre de places assises (le chiffre de gauche se rapporte aux places des compartiments A)

Bei Personenwagen mit zwei Wagenklassen, Zeichen für :

- Eigengewicht, einschließlich 50 % Wasservorrat (links),
- Gesamtgewicht,
- Anzahl der Sitzplätze (die linke Zahl gibt die Platzzahl für die A-Abteile an).

Sign denoting, for two-class vehicles :

- the tare weight including 50 % of the water reserve (on left side),
- the number of seats (the figure on left side relating to seats in compartment A).

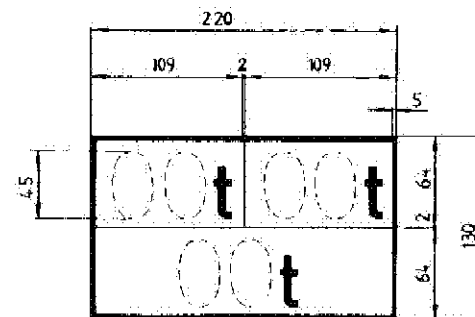
Fig. } 4c  
Bild }

Signe indiquant, pour les fourgons et les voitures-poste :

- la tare, y compris 50 % de la réserve d'eau (à gauche),
- la masse totale,
- la limite de charge.

Bei Gepäck- und Postwagen, Zeichen für :

- Eigengewicht, einschließlich 50 % Wasservorrat (links),
- Gesamtgewicht,
- Lastgrenze.

Sign denoting, for baggage and mail vans :

- the tare weight including 50 % of the water reserve (on left side)
- the total weight,
- the load limit.

Fig. 4d  
Bild

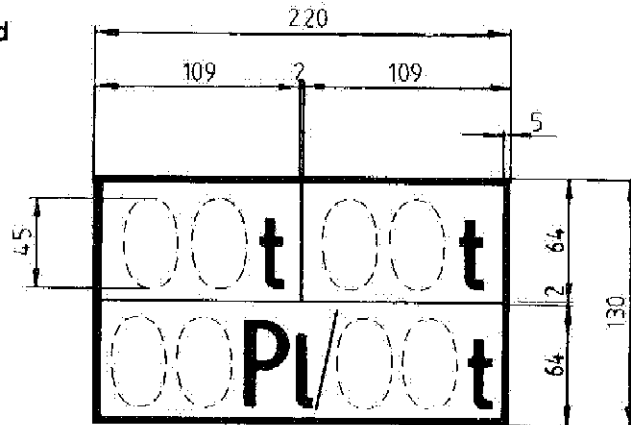

Signe indiquant pour les voitures avec compartiment à bagages :

- la tare, y compris 50 % de la réserve d'eau (à gauche),
- la masse totale,
- le nombre des places assises (à gauche),
- la limite de charge.

Bei Personenwagen mit Gepäckabteil, Zeichen für :

- Eigengewicht, einschließlich 50 % Wasservorrat (links),
- Gesamtgewicht,
- Anzahl der Sitzplätze (links),
- Lastgrenze.

Sign denoting, for vehicles with baggage compartment :

- the tare weight including 50 % of water reserve (on left side),
- the total weight,
- the number of seats on left side),
- the load limit.

Fig. 5  
Bild

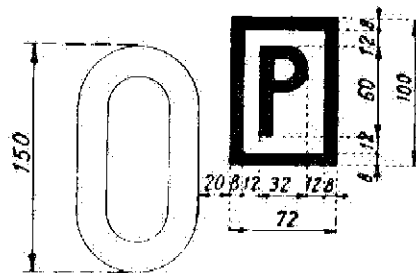

Véhicules à voyageurs de particuliers.  
Privatreisezugwagen.  
Privately-owned passenger vehicles.

Signes et inscriptions relatifs au frein - Bremsanschriften

Frein Bremsen Brake	xx-GPR (1)	x (2)	⬡ (3)	00t (7),(9)	00 % (8) (9)
			⬡	00t	00 %
Frein Bremsen Brake	xx-PR	x	⬡	00t (9)	00 % (9)
			⬡	00t	00 %
			P	00t	00 %
Frein Bremsen Brake	xx-R	x	⬡	00 (9)	00 % (9)
			⬡	00t (00t) (10)	00 %
Frein Bremsen Brake	xx-R	x		00t	00 %
Frein Bremsen Brake	xx-GPR	x	R (4)	00t	00 %
			P	00t	00 %
			G	00t	00 %
Frein Bremsen Brake	xx-PR	x	R	00t	00 %
			P	00t	00 %
Frein Bremsen Brake	xx-GP	x	P	00t	00 %
			G	00t	00 %
Frein Bremsen Brake	xx-R	x		00t (00t) (10)	00 %
Frein Bremsen Brake	xx-P	x		00t	00 %

## und Zeichen -- Brake signs and inscriptions

- (1) Désignations abrégées des freins à air comprimé admis en trafic international selon la fiche UIC N° 545, annexe 1.  
Kurzbezeichnungen der im internationalen Verkehr zugelassenen Druckluftbremsen nach UIC-Merkblatt 545, Anlage 1.  
Abbreviated designations for compressed-air brakes accepted in international traffic as per UIC leaflet 545, Appendix 1.
- (2) Marque distinctive pour / Zeichen für / Distinctive marking for :
- (D) Freins à disques / Scheibenbremsen / Disc brakes  
(fiche UIC N° 545, annexe 7 / UIC-Merkblatt Nr. 545, Anlage 7 / UIC leaflet 545, appendix 7).
  - (K) Semelles en matière composite / Kompositionsbremsschalen / Composite brake shoe inserts  
(fiche UIC N° 545, annexe 6 / UIC-Merkblatt Nr. 545, Anlage 6 / UIC leaflet 545, appendix 6).
  - (ep) Frein à commande électropneumatique / Elektropneumatische Bremse / Electropneumatic brake  
(fiche UIC N° 545, annexe 8 / UIC-Merkblatt Nr. 545, Anlage 8 / UIC leaflet 545, appendix 8).
- (3) Frein  $\diamond$  , pourcentage de masse freinée } 150 ... 170 %  
 $\diamond$  -Bremsen, Brems Hundertstel }  
 $\diamond$  Brake, braked weight percentage }  
 (fiche UIC N° 545, annexe 2 / UIC-Merkblatt Nr. 545, Anlage 2 / UIC leaflet 545, appendix 2).
- 4) Frein à haute-puissance } 121 ... 149 %  
 Hochleistungsbremse }  
 High performance brake. }
- 5) Freins pour trains voyageurs } 105 ... 120 %  
 Personenzugbremse (P) }  
 Passenger train brakes. }
- (6) Frein pour trains marchandises.  
 Güterzugbremse.  
 Freight train brake.
- (7) Masse freinée correspondant à chaque régime de freinage.  
 Bremsgewicht für jede Bremsstellung.  
 Braked weight corresponding to each brake pitch.
- (8) Pourcentage de freinage par rapport au véhicule vide correspondant à chaque régime de freinage (facultatif).  
 Brems Hundertstelsatz des leeren Wagens für jede Bremsstellung (nicht verbindlich).  
 Braking percentage (in relation to empty state vehicle) corresponding to each brake pitch (optional).
- (9) Avec accélérateur de vidange de conduite ; inscriptions à marquer au moyen de la couleur rouge.  
 Mit Schnellbremsbeschleuniger ; Angaben in roter Farbe anzuschreiben.  
 With pipe discharge accelerator ; inscriptions to be shown in red.
- (10) Sur les voitures qui possèdent uniquement le frein R, la masse freinée de l'étage inférieur seul peut être ajoutée entre parenthèses.  
 Bei Wagen, die nur die R-Bremsen besitzen, kann das Bremsgewicht für die niedrige Abbremsstufe in Klammern beigelegt werden.  
 On vehicles only fitted with the R brake, the braked weight to lower state solely can be shown in brackets.

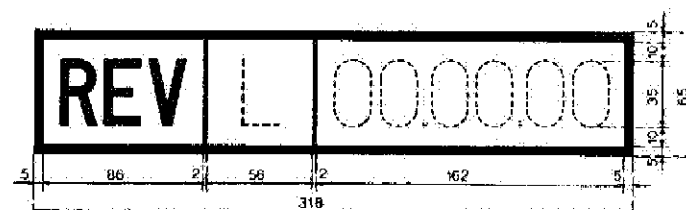
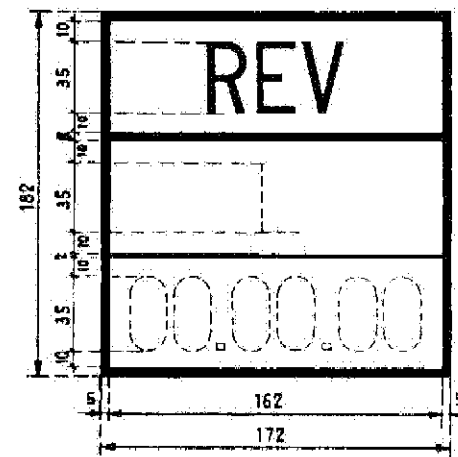
Signe de la dernière révision  
Zeichen für die letzte Revision (Untersuchung)  
Sign denoting last overhaulFig. }  
Bild } 1Fig. }  
Bild } 2

Signe d'avertissement  
Warnungszeichen  
Warning sign

ANNEXE 12  
ANLAGE 12  
APPENDIX 12

Fig. } — Pour le matériel existant.  
Bild } 1 — Für die vorhandenen Fahrzeuge.  
Fig. } — For existing vehicles.

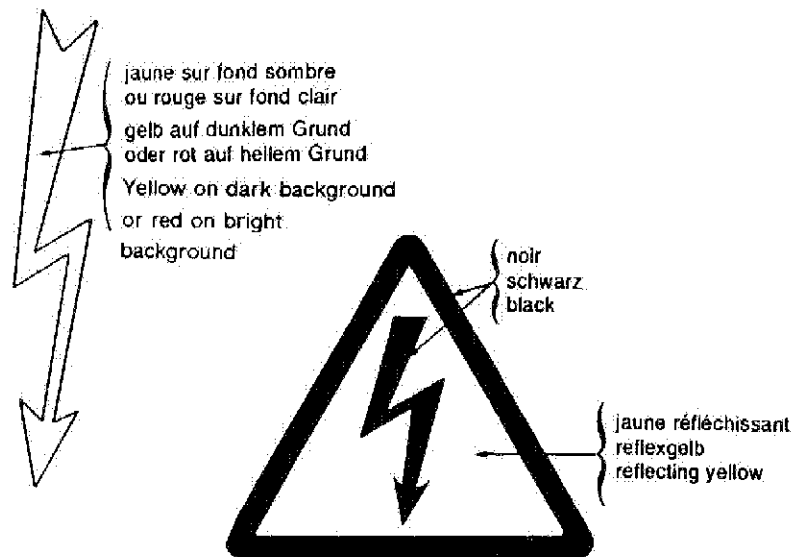

Fig. } — Pour le matériel à construire à partir du 1.1.1987.  
Bild } 2 — Für die ab 1.1.1987 neuzubauenden Fahrzeuge.  
Fig. } — For vehicles to be built as from 1.1.1987.

- Remarques : — la taille des signes doit être adaptée selon l'endroit où ils sont apposés,  
— en cas de remplacement, sur le matériel existant, du signe selon fig. 1, il est recommandé d'apposer le signe selon fig. 2.
- Bemerkungen : — Die Größe der Zeichen richtet sich nach der Stelle, wo sie angebracht werden,  
— Wenn bei den vorhandenen Fahrzeugen das Zeichen gemäß Bild 1 zu erneuern ist, wird empfohlen, dafür das Zeichen gemäß Bild 2 anzubringen.
- Remarks : — Signs must be dimensioned to fit the spaces where they are affixed.  
— If, on existing vehicles, the sign corresponding to Fig. 1 is to be replaced, it is recommended that the sign as per Fig. 2 be affixed.

ANNEXE 13  
ANLAGE 13  
APPENDIX 13

Signe pour les véhicules équipés du dispositif électropneumatique de fermeture des portes et de la télécommande de l'éclairage.

Zeichen für Wagen mit electropneumatischer Türschließung und Fernsteuerung der Beleuchtung.

Sign for vehicles fitted with electropneumatic door-closing system and remote control of lighting

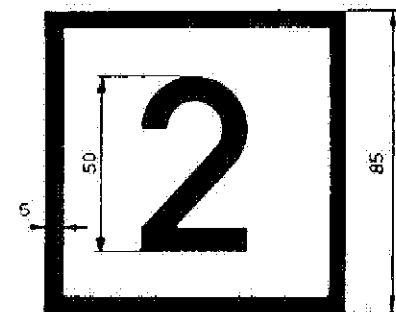



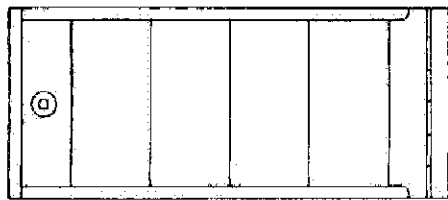

Fig. 3\*  
Bild

\* ) Un cadre doit être placé de chaque côté de la porte du compartiment. Je ein Rahmen ist auf beiden Seiten der Abteiltür anzubringen. A frame must be placed on each side of the compartment door.

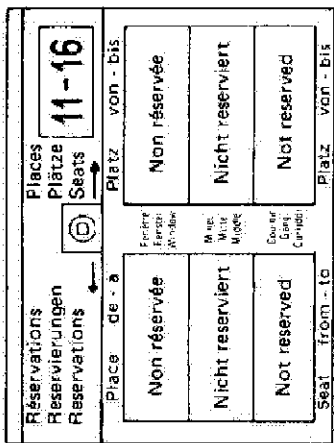

Fig. 2  
Bild

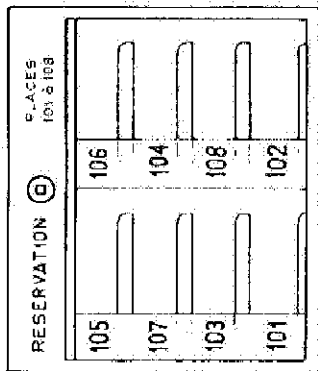

Fig. 1  
Bild

1 - Numérotage des places pour les voitures.  
 Platznumerierung für Personenwagen.  
 Seat numbering in coaches.

Voiture à couloir central 1<sup>re</sup> classe / Wagen mit Mittelgang 1. Klasse / Centre-aisle coach 1st Class.

15 18	25 28	35 38	45 48	55 58	65 68	75 78	85 88	95 98	105 108
13 14	23 24	33 34	43 44	53 54	63 64	73 74	83 84	93 94	103 104
11 12	21 22	31 32	41 42	51 52	61 62	71 72	81 82	91 92	101 102
1	2	3	4	5	6	7	8	9	10

Voiture à couloir central 2<sup>e</sup> classe / Wagen mit Mittelgang 2. Klasse / Centre-aisle coach 2nd Class.

18 16	25 26	35 38	45 48	55 58	65 68	75 78	85 86	95 96	105 106	115 116	125 126
17 14	27 24	37 34	47 44	57 54	67 64	77 74	87 84	97 94	107 104	117 114	127 124
13 18	23 28	33 38	43 48	53 58	63 68	73 78	83 88	93 98	103 108	113 118	123 128
11 12	21 22	31 32	41 42	51 52	61 62	71 72	81 82	91 92	101 102	111 112	121 122
1	2	3	4	5	6	7	8	9	10	11	12

Voiture à sièges orientables à 4 places de front / Wagen mit verstellbaren Sitzen zu 4 Plätzen je Querbühne / Coach with 4. Abraast swivel seats.

65	61	55	51	45	41	35	31	25	21	15	11	5	1
66	62	56	52	46	42	36	32	26	22	16	12	6	2
68	64	58	54	48	44	38	34	28	24	18	14	8	4
67	63	57	53	47	43	37	33	27	23	17	13	7	3

Voiture à couloir latéral 1<sup>re</sup> classe / Wagen mit Seitengang 1. Klasse / Side-corridor coach 1st Class

15 16	25 26	35 36	45 46	55 56	65 66	75 76	85 86	95 96	105 106	115 116	125 126
13 14	23 24	33 34	43 44	53 54	63 64	73 74	83 84	93 94	103 104	113 114	123 124
11 12	21 22	31 32	41 42	51 52	61 62	71 72	81 82	91 92	101 102	111 112	121 122
1	2	3	4	5	6	7	8	9	10	11	12

Voiture à couloir latéral 2<sup>e</sup> classe / Wagen mit Seitengang 2. Klasse / Side-corridor coach, 2nd class

15 16	25 26	35 36	45 46	55 56	65 66	75 76	85 86	95 96	105 106	115 116	125 126
17 14	27 24	37 34	47 44	57 54	67 64	77 74	87 84	97 94	107 104	117 114	127 124
13 18	23 28	33 38	43 48	53 58	63 68	73 78	83 88	93 98	103 108	113 118	123 128
11 12	21 22	31 32	41 42	51 52	61 62	71 72	81 82	91 92	101 102	111 112	121 122
1	2	3	4	5	6	7	8	9	10	11	12

Pour les voitures de 2<sup>e</sup> classe à 6 places par compartiment, les places sont numérotées comme dans les voitures de 1<sup>re</sup> classe.  
 Bei Wagen 2. Klasse mit 6 Plätzen je Abteil entspricht die Platznumerierung der in der 1. Klasse.  
 For 2nd Class coaches with 6 seater compartments seats are numbered similarly to 1st Class coaches.

**2 - Disposition et numérotage des compartiments fumeurs et non fumeurs.  
Anordnung und Numerierung der Raucher- und Nichtraucherabteile.**

Arrangement and numbering in "smoker" and "non-smoker" compartments.

Categorie de voiture Wagengattung Coach type	Disposition et numérotage des compartiments fumeurs et non fumeurs Anordnung und Numerierung der Raucher- und Nichtraucherabteile Arrangement and numbering in "smoker" and "non-smoker" compartments																						
A10	<table border="1"> <tr> <td>1</td><td>2</td><td>3</td><td>4</td><td>5</td><td>6</td><td>7</td><td>8</td><td>9</td><td>10</td> </tr> </table>	1	2	3	4	5	6	7	8	9	10												
1	2	3	4	5	6	7	8	9	10														
A9	<table border="1"> <tr> <td>1</td><td>2</td><td>3</td><td>4</td><td>5</td><td>6</td><td>7</td><td>8</td><td>9</td> </tr> </table>	1	2	3	4	5	6	7	8	9													
1	2	3	4	5	6	7	8	9															
B12	<table border="1"> <tr> <td>1</td><td>2</td><td>3</td><td>4</td><td>5</td><td>6</td><td>7</td><td>8</td><td>9</td><td>10</td><td>11</td><td>12</td> </tr> </table>	1	2	3	4	5	6	7	8	9	10	11	12										
1	2	3	4	5	6	7	8	9	10	11	12												
B11	<table border="1"> <tr> <td>1</td><td>2</td><td>3</td><td>4</td><td>5</td><td>6</td><td>7</td><td>8</td><td>9</td><td>10</td><td>11</td> </tr> </table>	1	2	3	4	5	6	7	8	9	10	11											
1	2	3	4	5	6	7	8	9	10	11													
B10	<table border="1"> <tr> <td>1</td><td>2</td><td>3</td><td>4</td><td>5</td><td>6</td><td>7</td><td>8</td><td>9</td><td>10</td> </tr> </table>	1	2	3	4	5	6	7	8	9	10												
1	2	3	4	5	6	7	8	9	10														
A6 B6	<table border="1"> <thead> <tr> <th colspan="5">A</th> <th colspan="6">B</th> </tr> </thead> <tbody> <tr> <td>1</td><td>2</td><td>3</td><td>4</td><td>5</td> <td>6</td><td>7</td><td>8</td><td>9</td><td>10</td><td>11</td> </tr> </tbody> </table>	A					B						1	2	3	4	5	6	7	8	9	10	11
A					B																		
1	2	3	4	5	6	7	8	9	10	11													
A4 B6	<table border="1"> <tr> <td>1</td><td>2</td><td>3</td><td>4</td> <td>6</td><td>7</td><td>8</td><td>9</td><td>10</td><td>11</td> </tr> </table>	1	2	3	4	6	7	8	9	10	11												
1	2	3	4	6	7	8	9	10	11														
A4 B5	<table border="1"> <tr> <td>1</td><td>2</td><td>3</td><td>4</td> <td>7</td><td>8</td><td>9</td><td>10</td><td>11</td> </tr> </table>	1	2	3	4	7	8	9	10	11													
1	2	3	4	7	8	9	10	11															
	<table border="1"> <tr> <td>Non-fumeurs Nichträucher Non-smoker</td> <td>Fumeurs Raucher Smoker</td> </tr> </table>	Non-fumeurs Nichträucher Non-smoker	Fumeurs Raucher Smoker																				
Non-fumeurs Nichträucher Non-smoker	Fumeurs Raucher Smoker																						

**Cadre RIC — RIC-Raster — RIC Frame**

Fig. } 1  
Bild } 1

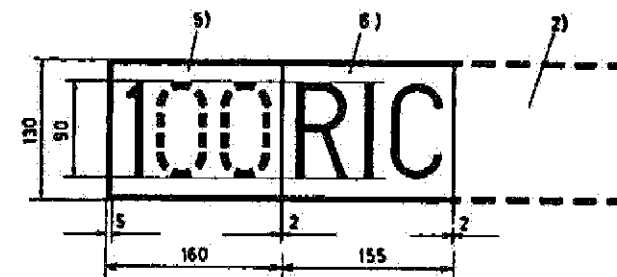

**Signe pour véhicules :**

- satisfaisant aux prescriptions du numéro 31.1, RIC,
- pouvant circuler à la vitesse maximale indiquée dans le cadre à gauche du signe RIC.

**Zeichen für Wagen :**

- die den Vorschriften von RIC, Ziffer 31.1 entsprechen,
- die mit der im Feld links des RIC-Zeichens angegebenen Höchstgeschwindigkeit verkehren können.

**Sign for vehicles :**

- complying with the provisions of RIC point 31.1,
- suitable for running at the maximum speed specified in the frame to the left of the RIC mark.

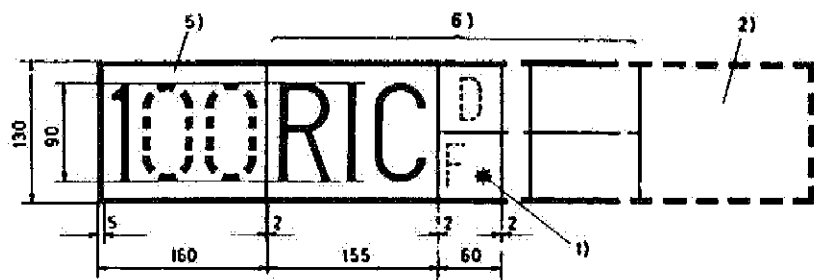
Fig. } 2  
Bild } 2

## Signe pour véhicules :

- satisfaisant aux prescriptions du numéro 31.1, RIC,
- pouvant circuler à la vitesse maximale indiquée dans le cadre à gauche du signe RIC,
- répondant aux conditions spéciales de l'Annexe II au RIC, seulement pour les Réseaux sur lesquels les véhicules peuvent circuler.

## Zeichen für Wagen :

- die den Vorschriften von RIC, Ziffer 31.1 entsprechen,
- die mit der im Feld links des RIC-Zeichens angegebenen Höchstgeschwindigkeit verkehren können,
- die den besonderen Bedingungen der Bahnen, auf deren Strecken sie verkehren sollen (siehe RIC, Anlage II), entsprechen.

## Sign for vehicles :

- complying with the provisions of RIC point 31.1,
- suitable for running at the maximum speed specified in the frame to the left of the RIC mark,
- observing the special conditions listed in RIC appendix II, solely for those railways on whose lines these vehicles can operate.

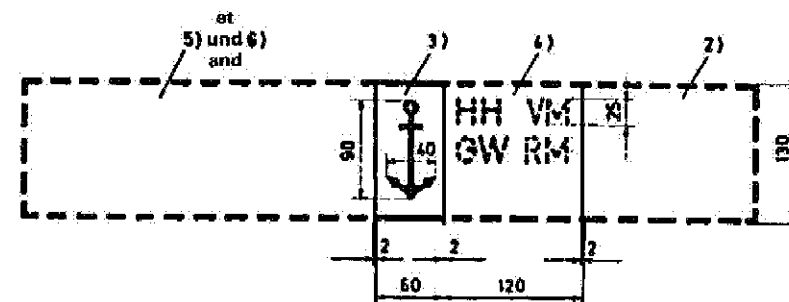
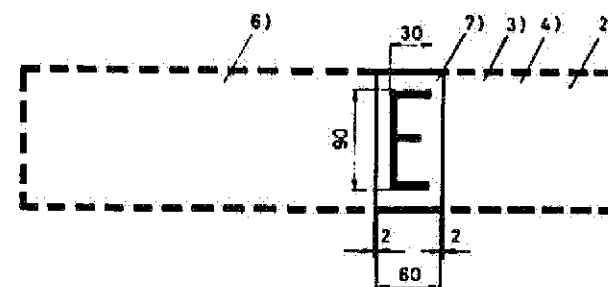

Fig. } 3  
Bild } 3Fig. } 4  
Bild } 4

Signes supplémentaires pour les véhicules satisfaisant aux conditions de l'Annexe IV RIC.

Zusätzliche Zeichen für Wagen, die den Bedingungen des RIC, Anlage IV, entsprechen.

Additional signs for vehicles fulfilling the conditions in RIC appendix IV.

ANNEXE 16  
ANLAGE 16  
APPENDIX 16

1. Les véhicules qui ne répondent pas aux conditions spéciales exigées à l'Annexe II RIC, par un Réseau pour certaines de ses lignes, reçoivent, dans le cadre du signe RIC, le signe \*, placé auprès du symbole de ce Réseau.  
Wagen, die den besonderen Bedingungen einer Bahn nach RIC, Anlage II, für einzelne ihrer Strecken nicht entsprechen, erhalten neben der Kurzbezeichnung dieser Bahn im Raster des RIC-Zeichens das Zeichen \*.  
Any vehicle which does not fulfill the special conditions listed in RIC appendix II and imposed by a railway for some of its lines, shall be identified, in the frame containing the RIC mark, by an asterisk positioned near the symbol of this railway.
2. Faire figurer dans ce cadre les inscriptions relatives au chauffage électrique qui figurent au chapitre 5 de la fiche UIC N° 552.  
In diesem Feld werden die Anschriften der elektrischen Heizung nach UIC-Merkblatt 552, Kapitel 5, angebracht.  
This frame shall bear the inscriptions for electric heating specified in section V of UIC leaflet 552.
3. Les véhicules qui répondent aux conditions générales de la fiche UIC N° 569 pour le passage sur des ferry-boats reçoivent ce signe figurant une ancre.  
Wägen, die den allgemeinen Bedingungen für den Übergang auf Fähren nach UIC-Merkblatt 569 entsprechen, erhalten dieses Ankerzeichen.  
Vehicles which comply with the general conditions imposed by leaflet 569 for conveyance in train ferries, shall bear this sign representing an anchor.
4. Désignation abrégée du trajet de ferry-boat selon Annexe IV, RIC, que les véhicules sont aussi aptes à emprunter.  
Kurzbezeichnung der Fährlinie nach RIC, Anlage IV, für die die Wagen außerdem zugelassen sind.  
Abbreviated designation of the train-ferry crossing as per RIC appendix IV, by which the vehicles may also be forwarded.
5. Vitesse maximale à laquelle le véhicule peut circuler.  
Höchstgeschwindigkeit, mit der der Wagen verkehren kann.  
Maximum permitted speed of the vehicle.
6. Signe , selon figure 1 ou 2.  
Zeichen  nach Bild 1 oder 2.  
 mark, as per figure 1 or 2.
7. Signe supplémentaire pour les véhicules satisfaisant aux conditions de circulation sur les lignes de la RENFE et des CP (fiche UIC N° 430-2).  
Zusätzliches Zeichen für Wagen, die den Bestimmungen für den Übergang zur RENFE und der CP entsprechen (UIC-Merkblatt 430-2).  
Additional sign for vehicles fulfilling running conditions on RENFE and CP lines (UIC leaflet 430-2).

## Application

With effect from 1 January 1990 for obligatory provisions, except as regards:

- Points 0.2 to 0.7, 1.3, 4.1 to 4.3.3..... which will also apply to existing coaches, once they have been repainted.
- Points 1.5.1.1, 1.5.10.2 ..... 1.1.91
- Point 1.5.10.3..... 1.1.94
- Points 2.1.1, 2.1.1.1 ..... 1.7.90
- Point 5.1.4 ..... 1.1.94

All UIC Members

## Record references

*Last headings under which the question has been studied:*

- Question 45/A/FIC - Revision of leaflets.  
Point 8.1.2 - Alignment of RIC regulations with the provisions of Leaflet 580.  
(Joint Sub-Committee for Coaches: Paris, May 1989).

## O R

- *Question 45/A/FIC* - Revision of leaflets.  
Point 8.10 - Leaflet 580 "Inscriptions and markings, route indicators and number plates to be affixed to coaching stock used in international traffic".  
(Joint Sub-Committee for Coaches: Paris, January 1990).
  
- *Question 45/A/FIC* - Revision of leaflets.  
17.5 - Amendments resulting from the drawing up of Leaflet 567.  
(Traction and Rolling Stock Committee: Paris, June 1990).
  
- *Question 45/A/20* - Standardisation of leaflets.  
(Sub-Committee for Coaches: Paris, June 1993).

All rights reserved.  
No part of this publication may be reproduced or used in any form or using any procedure, whether electronic or mechanical, including photocopy and microfilm, without the prior assent of the publisher.

© 1993 International Union of Railways  
16, rue Jean Rey - 75015 Paris (France)  
ISBN n° pending.