

3rd edition, October 2007

Translation

OR

Roller units for horizontal transshipment - Technical conditions governing their use in international traffic

Caisses amovibles pour transbordement horizontal - Conditions techniques à remplir pour l'utilisation en trafic international

Transportbehälter für den horizontalen Umschlag - Technische Bedingungen für den Einsatz im internationalen Eisenbahnverkehr



Leaflet to be classified in Volumes:

IV - Operating

V - Transport stock

Application:

With effect from 01.09.2004

All members of the International Union of Railways

Record of updates

1st edition, January 1992

Published under the title: "Transport frames for horizontal transshipment - Technical conditions governing their use in international traffic"

2nd edition, January 1998

3rd edition, October 2007

Incorporation into the text of leaflet no. 591 of the specifications of the RID code for roller units adapted for the transport of dangerous goods. Adaptation of Appendix F to point 2.2 of the leaflet. Conforming to editorial guide M1.

The person responsible for this leaflet is named in the UIC Code

Contents

Summary	1
1 - General Comments	2
2 - General conditions applicable to all roller units	3
3 - Conditions to be observed according to the transfer system(s) used	6
Appendix A - Tests on roller units - Test methods and results.....	9
A.1 - Longitudinal dynamic stress test.....	9
A.2 - Strength test for sides.....	10
A.3 - Lifting test (if necessary).....	10
A.4 - Stacking test (if necessary).....	10
A.5 - Additional tests	10
A.6 - Special tests for roller units designed to carry dangerous goods	10
A.7 - Type-approval of the standard designs	11
Appendix B - Type-approval certificate	12
Appendix C - Identification	13
C.1 - Identification of roller units	14
C.2 - Code for the type of grabs	16
C.3 - Code for the type of locking	16
C.4 - Identification of roller units which can also use the special S profile	17
Appendix D - Markings	19
D.1 - Marking of roller units authorised in international rail traffic.....	19
D.2 - Example of ATP identification.....	19
Appendix E - Overviews of various systems	20
E.1 - ACTS system.....	20
E.2 - SNCF system.....	21
E.3 - RSS system	22

Appendix F - Compatibility diagrams	23
F.1 - SNCF \Leftrightarrow ACTS Compatibility	23
F.2 - ACTS \Leftrightarrow RSS Compatibility	24
F.3 - SNCF \Leftrightarrow RSS Compatibility	25
F.4 - ACTS \Leftrightarrow RSS \Leftrightarrow SNCF Compatibility	26
List of abbreviations	27
Bibliography	28

Summary

This leaflet sets out the technical conditions which must be met so that roller units basically designed for conveyance on road vehicles may also be carried without difficulty by rail.

The rules laid out in this document mainly cover permissible dimensions, securing devices on wagons, the strength of the roller units and their identification markings.

1 - General Comments

This leaflet sets out the technical conditions which must be met so that roller units basically designed for conveyance on road vehicles may also be carried without difficulty by rail.

The roller units described in this leaflet can only be transported by rail on special wagons.

As a general rule, there is no obligation on railways to undertake transshipment. Any exception to this rule shall be subject to specific agreements with railways in which the specific rules applicable under particular conditions shall be clearly defined.

The rules laid out in this document mainly cover permissible dimensions, securing devices on wagons, the strength of the roller units and their identification markings.

Containers and roller units already covered by *UIC Leaflets 592-2 to 592-4* (see [Bibliography - page 28](#)) do not fall within the scope of this leaflet.

o 2 - General conditions applicable to all roller units

2.1 - For each roller unit it is necessary to acquire permanent permission for conveyance on special wagons. This may be issued by the appropriate RU, or delegated to one or several bodies specified by the railway concerned.

The operation of the technical acceptance procedure is left to each individual RU which can demand a certificate for each roller unit to prove that it is in conformity with the provisions set out above (see point 2 - page 7).

2.2 - The maximum outside width shall be 2 600 mm, irrespective of the loading status.

NB : A maximum width of 2 600 mm is acceptable for refrigerator roller units.

2.3 - Roller units shall be provided with fittings enabling them to be secured or locked in position on the wagon.

The actual fitting or additional fittings provided on the roller unit shall guide and hold the unit in the intended loading position.

2.4 - Where roller units are provided with fittings specified in other leaflets (e.g. corner fittings, recesses for the location of grapples arms, standing gear) the provisions contained in those leaflets shall apply.

2.5 - Apart from the conditions imposed by the competent national technical authorities or other equivalent organisations, roller units shall at least meet the requirements of the tests specified in Appendix A - page 13.

Since roller units may be carried in both directions of travel under SS conditions (120 km/h), their bodywork¹ shall be capable of withstanding wind forces, in particular the negative and positive pressures which occur when trains pass one another in tunnels. Where a roller unit is sheeted, the sheet must be secured to the body in such a way as to provide all necessary safeguards in the event of failure of a securing tie (TIR fastening).

2.6 - Where roller units are fitted with moveable or folding panels (for example roof, doors, side walls) they must be fitted with fastenings that ensure they remain closed under all circumstances, in particular during carriage by rail.

Door and shutter fastenings or other such devices shall have additional safeguards to prevent accidental opening.

Likewise, non-mechanical (hydraulic, pneumatic etc.) systems for fastening doors, shutters, etc. shall be fitted with an extra mechanical safety device on the side in an easily visible position.

The closed position of door fastenings and the effectiveness of the additional safeguards provided must be easily verifiable by staff standing on the ground.

2.7 - Tests undertaken shall be covered by a standard type-approval certificate completed by the railway concerned in accordance with the Appendix B - page 16.

1. In particular the doors, body-frame members and their attachments.

2.8 - Roller units shall be classified as specified in *UIC Leaflet 596-6* (see [Bibliography - page 28](#)) and the level of compatibility shall be determined as indicated in point [3.3 - page 12](#). The identification marks should also be applied in accordance with [Appendix C - page 17](#).

2.9 - Roller units used for international freight traffic conveyed under customs seal shall comply with the regulations of customs agreements in force.

2.10 - Roller units intended for refrigerated traffic shall comply with *ATP* regulations (see [List of abbreviations - page 27](#)) if they are required to carry traffic subject to this agreement and must, in particular, carry the markings specified in *Appendix 1, Annexe 4 to the ATP*. The [Appendix E - page 24](#) to this leaflet shows an example of this means of identification.

2.11 - Roller units fitted with ladders shall be affixed with a sign corresponding to *RIV Sheet 22 - plate 34* (see [List of abbreviations - page 27](#)) at the side of each ladder. Each rung of these ladders shall be able to withstand a weight of at least 200 kg.

2.12 - When all or part of the walls are non-existent or non-rigid, devices shall be fitted to enable the load to be secured on the base structure of the roller unit.

2.13 - Particular specifications for roller units intended to carry dangerous materials.

2.13.1 - Tanks shall be able to withstand an internal pressure of 0.3 bar.

2.13.2 - The filling and draining connections, as well as any other openings, with the exception of the automatic ventilation equipment, shall:

- when in the closed position, prevent any spontaneous opening, under the effect of a shock or an unintentional action,
- be arranged in such a way as to be protected against the risks of wrenching or of failure during transport or handling,
- be able to be sealed in the closed position,
- be able to be closed by screwed plugs, full flanges or comparable devices.

The filling and draining devices shall be protected by shields or covers.

It is recommended that tanks be equipped with filling and emptying devices on the top.

Tanks with bottom discharge facilities shall be fitted with a closing device which satisfies the following conditions:

- the closing device shall consist of a valve or tap,
- it shall be situated immediately below the discharge orifice of the tank,
- it shall be sufficiently protected by its position directly on the tank or by another method.

The arrangement of the drain pipes for bottom discharge shall enable them to be completely drained.

The body and handles of the drain taps shall be fixed in such a way that they cannot be removed except by force. The position and/or the direction of closing shall be unambiguously indicated.

It is recommended that the carrying frame of the tanks or the structure of the roller units should be designed such that it protrudes beyond the side parts of the tanks and their accessories (dome, filling and draining assembly etc.) so as to protect them against damage.

It is recommended that the tanks should be so designed that they can be drained preferably by pumping or by a pressurised system and not by gravity.

NB : The tanks referred to in points 2.13.2 and 2.13.3 require special authorisation before running on the UK network.

2.13.3 - Tank roller units used for the transport of liquids which give off gases other than those envisaged by the RID/ADR shall be designed so that any stress likely to cause damage is avoided.

If, to avoid this stress, the tanks are provided with automatic ventilation equipment, the latter shall be designed in such a way as to prevent the penetration of flames, the running out of liquid and any unauthorised sampling.

NB : The tanks referred to in points 2.13.2 and 2.13.3 require special authorisation before running on the UK network.

2.14 - Roller units intended for the transport of dangerous goods shall, moreover, meet the requirements of the RID.

The carrying frames of roll-off tanks shall meet the requirements concerning the design, fittings, commissioning of the prototype, checks and controls, as well as markings for tank units (section 6.8 of the RID).

3 - Conditions to be observed according to the transfer system(s) used

3.1 - General comments

Roller units for horizontal handling are units which have 2 side-bearers, one or several front-end grab handling fittings and one or two pairs of wheels at the rear. They may be loaded on special lorries and conveyed by road.

Each roller unit shall be fitted with at least one of the systems specified in point 3.2 and possibly with several depending on the compatibility criteria laid down in point 3.2.4 - page 11.

It is not necessary to use special devices for the horizontal transfer between the lorry and the wagon and vice versa.

3.2 - Roller units for one of the horizontal transfer systems using type 1 wagons of *UIC Leaflet 571-4, chapter 4* (see Bibliography - page 28) or equivalent.

3.2.1 - ACTS roller unit system (point E.1 - page 24)

System characteristics:

- length: max. 5 950 mm,
- folding grab-handling ring,
- saddle for chain attachment,
- additional railway rollers,
- longitudinal forces exerted on side-bearers.

The roller unit is slid onto the swivel frame once the frame has been swung out to receive it. A base plate serves to hold the unit. Railway rollers are used to facilitate loading on the swivel frame. Once the unit has slotted into place, these rollers are no longer under load and the roller unit will be borne by the side-bearers throughout its length on the swivel frame. When the unit has been positioned on the frame, the latter is realigned on the wagon centre-line and locked into position. Longitudinal forces are transmitted via the side bearers to two stops fixed to the wagon floor. This means that the side-bearers have to have a pre-set length of 5 850 mm and the maximum length of the roller unit is 5 950 mm. With arrangement A, to prevent lift at the rear and restrict lengthways movement of the roller unit on the swivel frame, two "U"-shaped stops placed flat at the end of the frame are provided so that the shaft or sections of the shaft of the railway rollers can fit into them. At the front, lift is prevented by means of a hook which fits into the chain attachment block.

With arrangement B, two pivoting clamps are provided as an additional protection against lifting. These hold the lower part of the side-bearer.

3.2.2 - SNCF roller units system (see point E.2 - page 25)

System characteristics:

- max. length: 5 950 mm,
- grab-handling ring with two different height settings,
- additional railway rollers,
- longitudinal forces exerted on side-bearers.

The roller unit is pushed by the lorry onto the pivoting frame after it has been turned. Railway rollers are provided to ease the loading on the pivoting frame and restrict movement. Once the roller unit has been placed on the pivoting frame, the frame is realigned on the wagon centre-line and locked into position.

Two safety hooks are provided to prevent lift and to counteract longitudinal forces transmitted by the wagon. These hooks are inserted via a scissors-shaped device into two recesses set in the side-bearers of the roller unit, which thus allows the roller units to be of variable lengths.

3.2.3 - RSS roller-unit system (see point E.3 - page 26)

System characteristics:

- max. length : 5 950 mm,
- fixed grab handling ring,
- longitudinal forces exerted on side-bearers.

The roller unit is pushed onto the swivel frame once the frame has been turned. The road wheels prevent excessive travel with the assistance of the two housings provided for these wheels in the swivel frame. Once the roller unit has been placed on the swivel frame, the frame is realigned on the wagon centre-line and locked into position.

Longitudinal loads are transmitted via the two road wheels to two locks fixed on the swivel frame that can be folded back. This enables the roller units to be other than of one specific length. The road wheels should not show any signs of permanent deformation which would prevent their rotational or lengthways stopping function, following tests in accordance with point A.1 - page 13.

Two pivoting clamps protect against lift and hold the underside of the side-bearer in position.

3.2.4 - Compatibility conditions between systems

Depending on the compatibility desired, the roller units of the horizontal trans-shipping system shall meet the conditions defined in the corresponding appendices.

3.2.4.1 - Compatibility between ACTS and SNCF

Relevant details are given in point F.1 - page 27, Fig. 1.

Moreover, the block for the chain attachment can be detachable or foldable.

3.2.4.2 - Compatibility between ACTS and RSS

Relevant details are given in point [F.2 - page 28](#), Fig. 2.

3.2.4.3 - Compatibility between RSS and SNCF

Relevant details are given in point [F.3 - page 29](#), Fig. 3.

3.2.4.4 - Compatibility between ACTS, RSS and SNCF

Relevant details are given in point [F.4 - page 30](#), Fig. 4.

Moreover, the block for the chain attachment can be detachable or foldable.

3.3 - Level of compatibility

The determination of the level of compatibility mentioned below the technical number B 000 regarding the 3 digit number is carried out as follows:

- the ACTS system has digit 1 in first position if not 0
- the SNCF system has digit 2 in second position if not 0
- the RSS system has digit 3 in the third position if not 0

Table 1 : Compatibility Table

System & combination	Identification
ACTS	100
SNCF	020
RSS	003
ACTS + SNCF	120
ACTS + RSS	103
ACTS + SNCF + RSS	123
SNCF + RSS	023

Appendix A - Tests on roller units - Test methods and results

(see point 2.5 - page 7)

Each roller unit shall have technical characteristics which are at least equivalent to those of a roller unit that passed the tests specified below.

The roller unit tested is deemed to be satisfactory if it meets the following condition:

Following any of these tests, it must not have abnormalities or deformations which would render it unfit for repeated use or affect its transshipment and securing.

For roller units of identical design, it shall suffice for one unit only to undergo the tests. Any deviation from the drawings, design and manufacturing process used for the roller unit requires the prior agreement of the railway, concerned, which shall decide whether all, or just some of the tests, shall be repeated.

If, by virtue of the roller-units design, tests additional to those required by this leaflet require to be carried out, these tests should, as far as possible, be conducted on the basis of those set out in *UIC Leaflets 592-2 to 592-4*.

In the case of roller units complying with point 3.2 - page 10, buffing impact tests shall be carried out using Category A buffers as specified in *UIC Leaflet 526-1* (see Bibliography - page 28).

In the tests described below:

- R = total authorised weight,
- P = payload.

A.1 - Longitudinal dynamic stress test

During these tests, the ability of the roller unit to withstand the dynamic loads arising during rail transport shall be verified.

The maximum speed of buffing impact shall be 11 km/h.

The roller unit shall be loaded to its maximum authorised weight, if possible with the commodities it is required to carry, and with the latter completely filling it. If other types of freight are used, these should have comparable physical characteristics to those normally carried. In such cases, the position of the overall centre of gravity shall not diverge by more than $\pm 10\%$ from normal operating conditions. In this loading condition the width used as a basis for the classification (railway type approval) shall not be exceeded. As an exception to *UIC Leaflet 571-4*, this wagon should be fitted with category A buffers for the tests.

The unit shall then be secured in position on its carrier wagon in the manner prescribed.

Buffing tests shall be undertaken at speeds of 5, 9 and 11 km/h, against a standard open unbraked bogie freight wagon. This vehicle shall be laden with bulk goods to provide a total weight of 80 t (*UIC Leaflet 577*) and the tests shall be carried out on level track. The speed shall be measured at a distance not exceeding 1 m before impact.

The buffing impact at maximum speed shall be repeated. If the roller unit is of non-symmetrical design, or if it can also be carried in the lateral direction, the tests shall also be undertaken for this direction with the wagon loaded with a single roller unit in the middle part.

A.2 - Strength test for sides

The tests shall be performed in the same way as Test 6 in *UIC Leaflet 592-2, point D.6*, and/or the Test in *UIC Leaflet 592-4, point H.6*.

A.3 - Lifting test (if necessary)

The tests shall be performed in the same way as the Tests in *UIC Leaflet 592-2, points D.2 and D.3, D.9 and D.10* and/or the Tests in *UIC Leaflet 592-4, point H.2 and H.3*.

A.4 - Stacking test (if necessary)

The tests shall be performed in the same way as the Test in *UIC Leaflet 592-2, Appendix D.1*.

A.5 - Additional tests

Test on the grapples equipment for roller units in accordance with point **3.2 - page 10**.

Apply to the grab equipment for the ring or the block for the chain attachment, a tensile and a compressive force of 0.75 R, first horizontally and then vertically, with a minimum of 150 kN. The force shall be maintained for at least 5 minutes in each direction, firstly as a tensile force, then as a compressive force. After the force has been removed there should be no permanent deformation.

A.6 - Special tests for roller units designed to carry dangerous goods

A.6.1 - In general, roller units shall be subjected to the tests specified in points **A.1 - page 13**, **A.3** and **A.4** in accordance with the procedures described therein.

To check their resistance to lateral and longitudinal inertia, they shall be subjected to the internal strength tests specified in *UIC Leaflet 592-2*, test described in *point D.11*, but with the plan of the lower corner pieces forming an angle of 30° to the horizontal, this corresponds to a force of 0.5 P.

The pressure tests (if necessary) shall be carried out in accordance with *UIC Leaflet 592-2, point D.12*.

A.6.2 - Roller units for the transport of dangerous goods shall be tested as specified in points **A.1**, **A.3** and **A.4** except for the test described in point **A.3** which will be carried out with a test load equal to 2R.

The internal stress tests to check the strength vis-à-vis the lateral and longitudinal inertia, just like the pressure test, (if necessary) shall be carried out as specified in *UIC Leaflet 592-2, points D.11 and D.12*.

A.7 - Type-approval of the standard designs

When the tests have been successfully completed, a type-approval certificate shall be prepared in accordance with Appendix **B - page 16**.

Only roller units which conform to the roller units described and tested in the certificate in question will be considered as approved.

Any modification subsequently carried out on approved roller units will result in the cancellation of the certificate.

Before any modification, it is necessary to contact the department that issued the certificate and obtain its written approval.

The railway that issues the type approval certificate is entitled to withdraw it if the nature of the roller units places the safety of railway operation at risk, or if the railway has been misled by incorrect information.

The certificate expires when the roller unit is withdrawn from traffic, scrapped or sold.

Appendix B - Type-approval certificate

(see point 2.7 - page 7)

Type-approval certificate number
SNCF 00 0000 000

By virtue of this certificate, the.....company is granted a type-approval certificate under the number given above, for the roller unit described below and intended for rail conveyance over UIC lines.

The type-approval certificate issued is valid for all other roller units produced by the same manufacturer that conform to the model tested.

Description of the roller unit:

Length x width x height	mm
Volume	l
Total authorised weight	kg
Tare	kg
Mass for stacking	kg

Drawing No.

Code No.

Compatibility Code

Code for type of grabs (see point C.2 - page 20)

Code for type of locking (see point C.3 - page 20)

Test report No. issued

on

.....

(place, date)

(Approving department)

Name, title and signature

Appendix C - Identification

(see point 2.8 - page 8)

Each roller unit shall be fitted with at least one of the plates specified in points **C.1 - page 18** or **C.4 - page 21** in a position where they remain clearly visible after the roller unit has been loaded onto a wagon.

If the roller unit is provided with ladders, a lightning flash symbol shall be placed near each ladder, in accordance with the *RIV sheet 22, plate 34*, to warn staff of the risk presented by the proximity of the overhead contact line.

If the roller unit meets RID requirements, the sign prescribed in the RID shall be shown.

C.1 - Identification of roller units

(see point 2.8 - page 8)

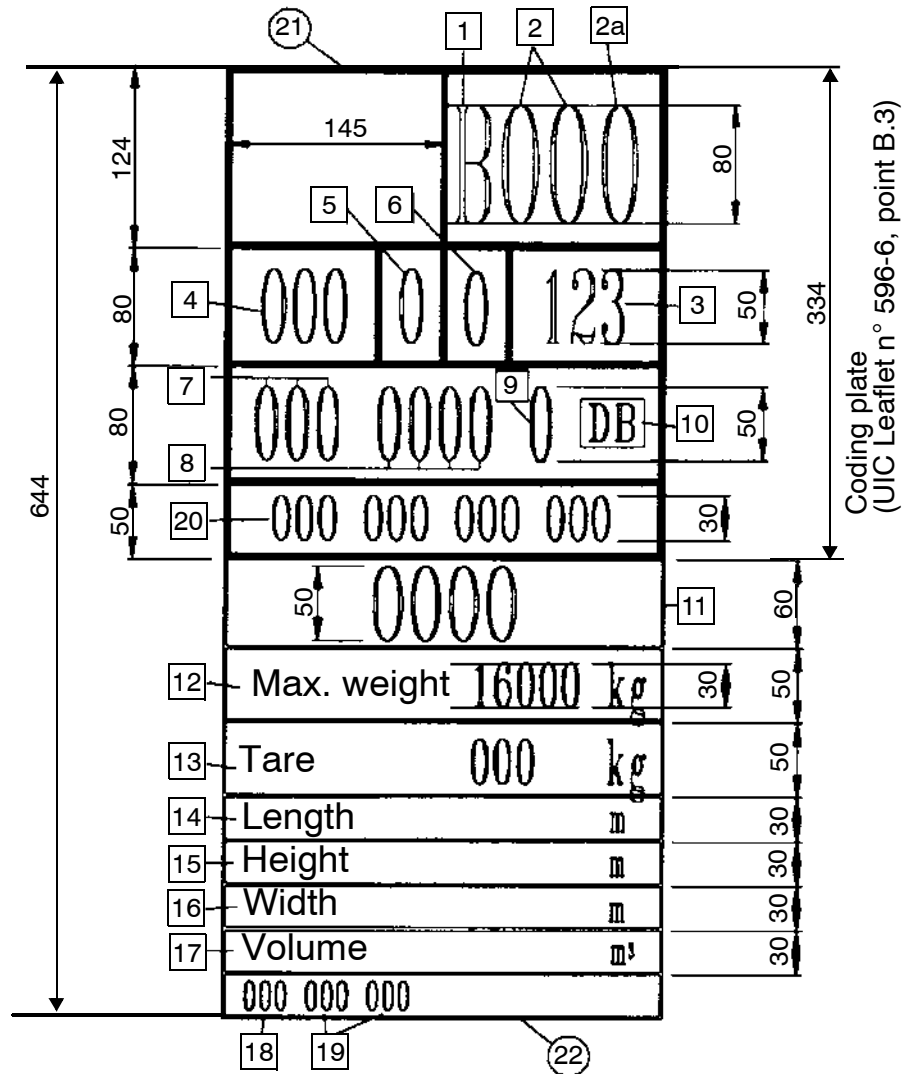

N.B. - line (21) should be 4 mm thick
line (22) should be 2 mm thick

*	1		Wagon compatibility code
*	2		Roller unit, maximum width 2,500 mm
*	2	+	2a Roller unit, width > 2 500 mm and ≤ 2 600 mm
*	3		Compatibility code
*	4		Registration RU
*	5		Type of grab (see point C.2 - page 20)
*	6		Type of locking (see point C.3 - page 20)
*	7		Owner
*	8		Owner's order number
*	9		Check digit
*	10		Check plate or mark of registering RU
*	11		Type (remains to be defined by the UIC)
*	12		Maximum weight
*	13		Tare
	14		Length
	15		Height
	16		Width
	17		Volume
	18		Manufacturer's number
	19		Drawing number and date of construction
	20		Frame number

C.2 - Code for the type of grabs

Characteristics	Code
Special type of grab, used only with bilateral agreement (is only possible in connection with the combination 00)	0
Grabs with block for chain attachment	1
Grabs with hooks and rings at a height of 1 425 mm	2
Grabs with hooks and rings at a height of 1 570 mm	3
Free	4
Grabs with variable hooks and rings at a height of 1 570 mm or 1 425 mm	5
Grabs with variable block for chain attachment and hooks, rings at a height of 1 425 mm	6
Grabs with variable block for chain attachment and hooks, rings at a height of 1 570 mm	7
Grabs with variable block for chain attachment and adjustable hooks, rings at a height of 1 570 mm or 1 425 mm	8
Free	9

C.3 - Code for the type of locking

Characteristics	Code
Locking reserved, used only with bilateral agreement (only possible in connection with the combination 00)	0
ACTS locking with block for chain attachment	1
ACTS locking ^a	2
ACTS locking with block for chain attachment and additional central locking	3
ACTS locking and SNCF locking ^a	4
SNCF locking	5
RSS locking and SNCF locking	6
ACTS locking and RSS locking	7
ACTS locking and SNCF locking and RSS ^a locking	8
RSS locking	9

a. As specified in form B, point 3.2.

C.4 - Identification of roller units which can also use the special S profile

(see point 2.8 - page 8)

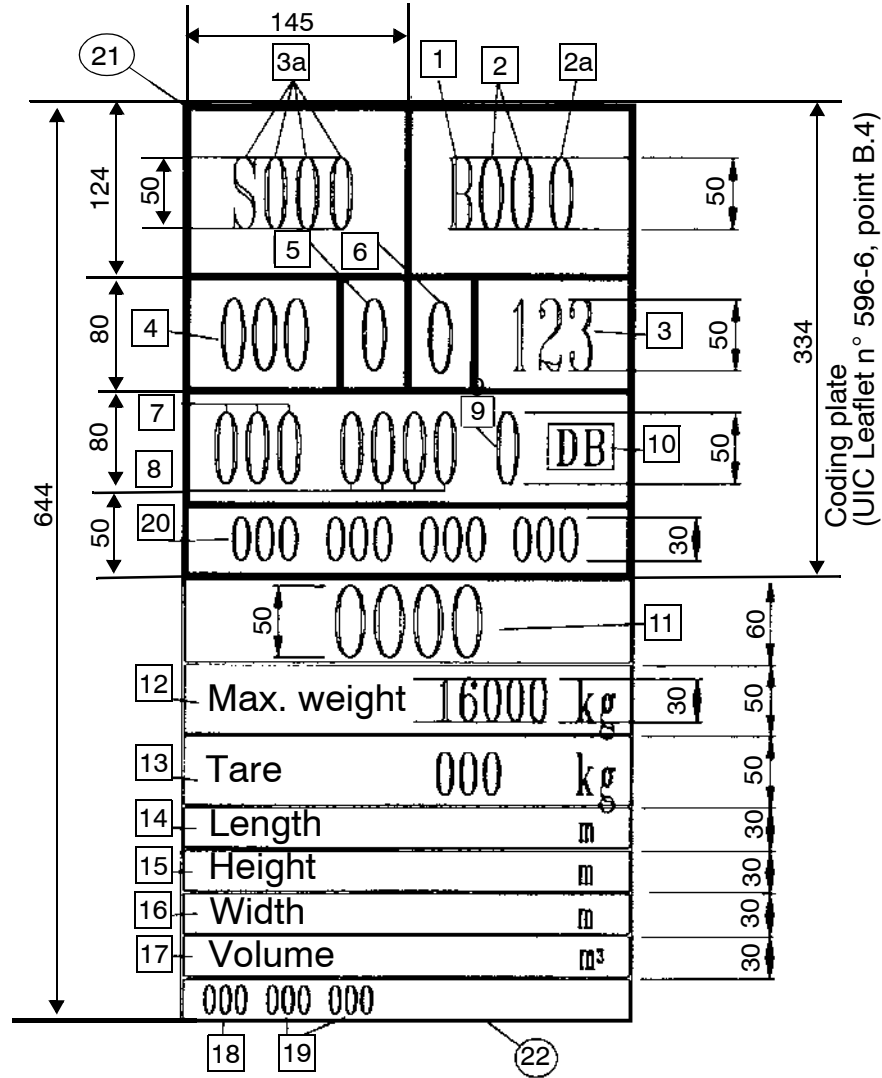

Attention - ligne (21) avec = 4 mm d'épaisseur
 ligne (22) avec = 2 mm d'épaisseur

*	1	Wagon compatibility code
*	2	Roller unit, maximum width 2 500 mm
*	2 + 2a	Roller unit, width > 2 500 mm and ≤ 2 600 mm
*	3	Compatibility code
*	3a	Special profile (<i>UIC Leaflet 596-6, Appendix G</i>)
*	4	Registration RU
*	5	Type of grab (<i>see point C.2 - page 20</i>)
*	6	Type of locking (<i>see point C.3 - page 20</i>)
*	7	Owner
*	8	Owner's order number
*	9	Check digit
*	10	Check plate or mark of registering RU
*	11	Type (remains to be defined by the UIC)
*	12	Maximum weight
*	13	Tare
	14	Length
	15	Height
	16	Width
	17	Volume
	18	Manufacturer's number
	19	Drawing number and date of construction
	20	Frame number

Appendix D - Markings

D.1 - Marking of roller units authorised in international rail traffic

(see point 2.9 - page 8)

(does not apply to roller units of point 3.2 - page 10)

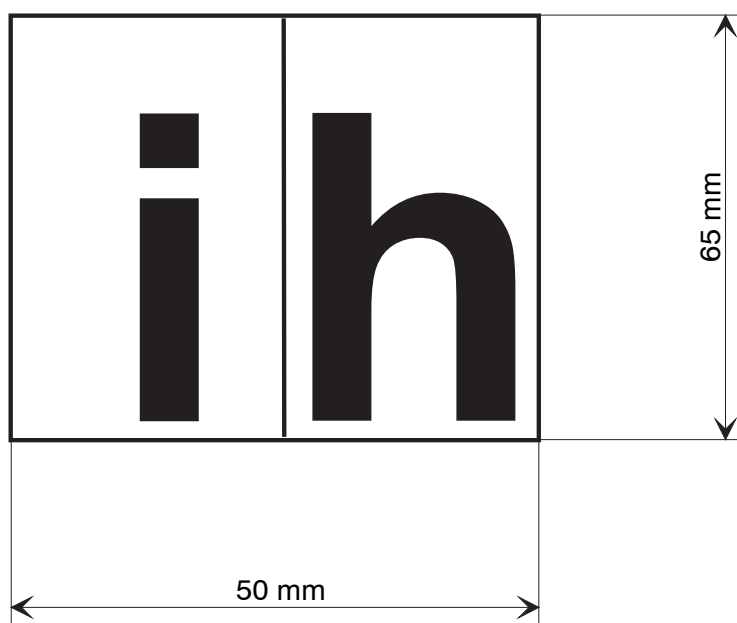

D.2 - Example of ATP identification

(see point 2.10 - page 8)

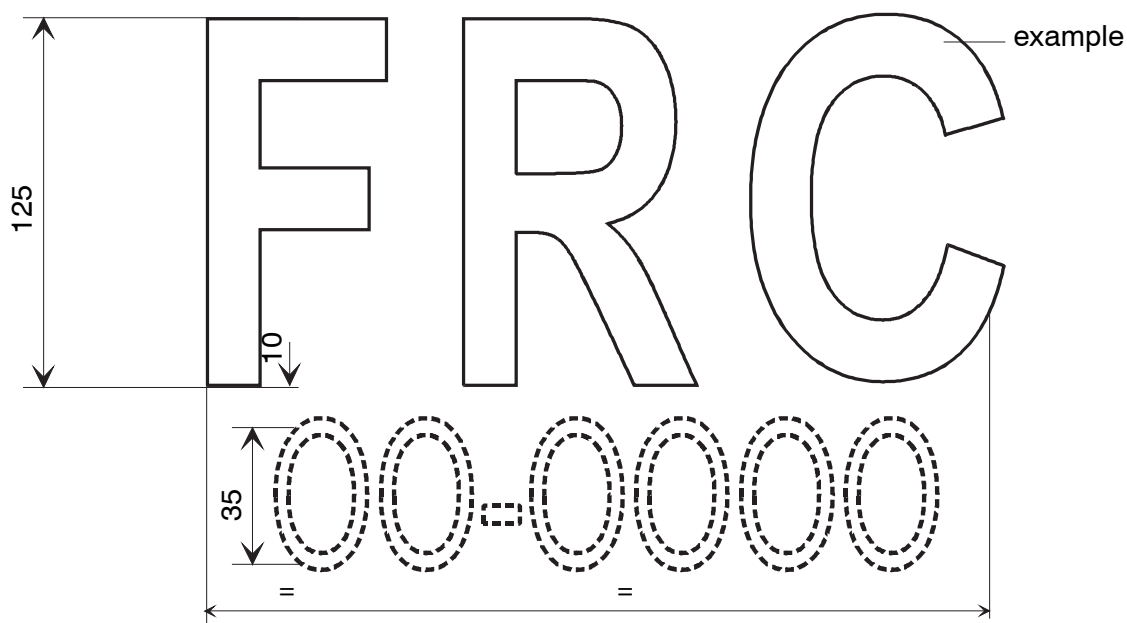

Appendix E - Overviews of various systems

E.1 - ACTS system

(see point 3.2.1 - page 10)

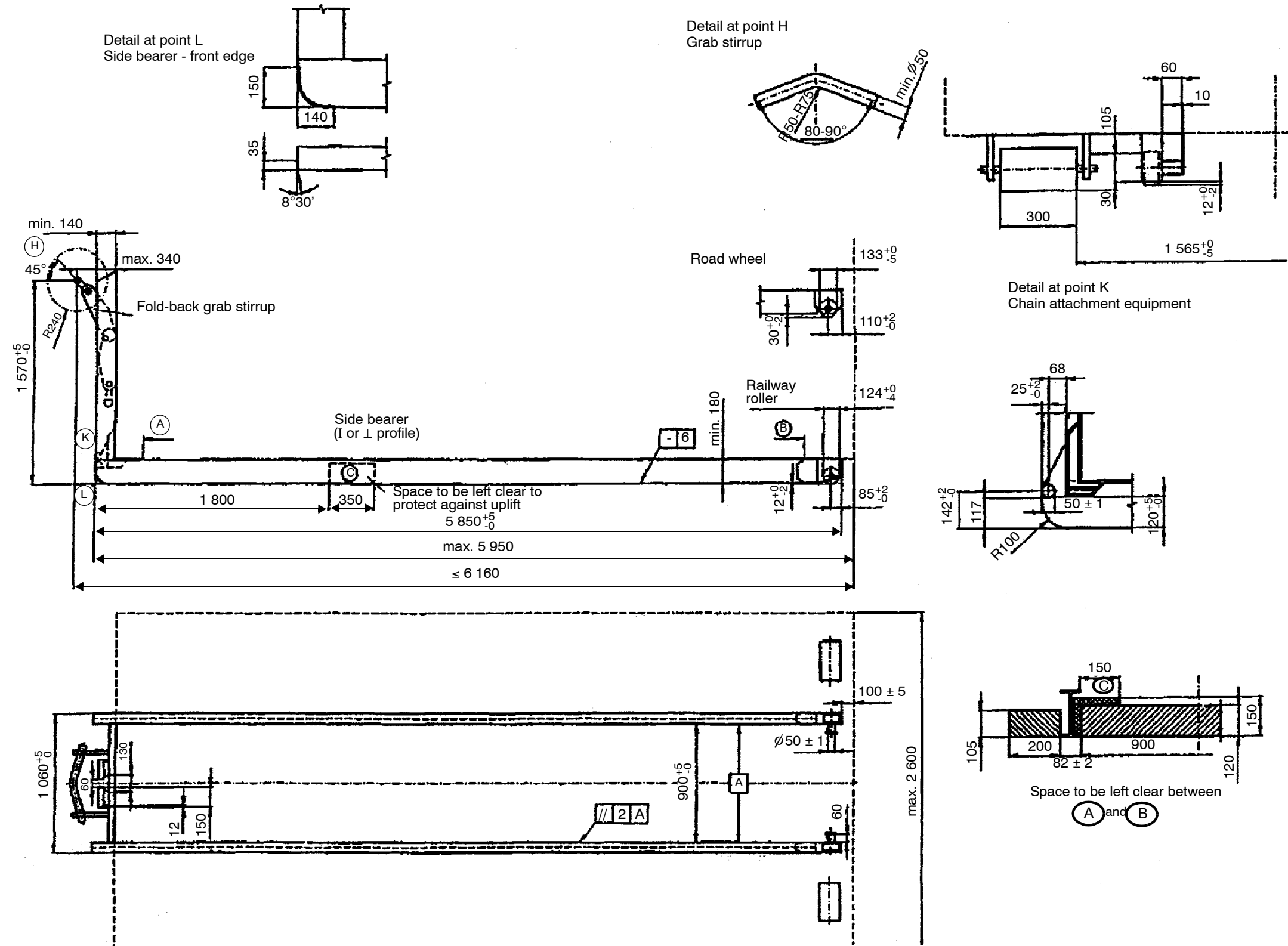

E.2 - SNCF system

(see point 3.2.2 - page 11)

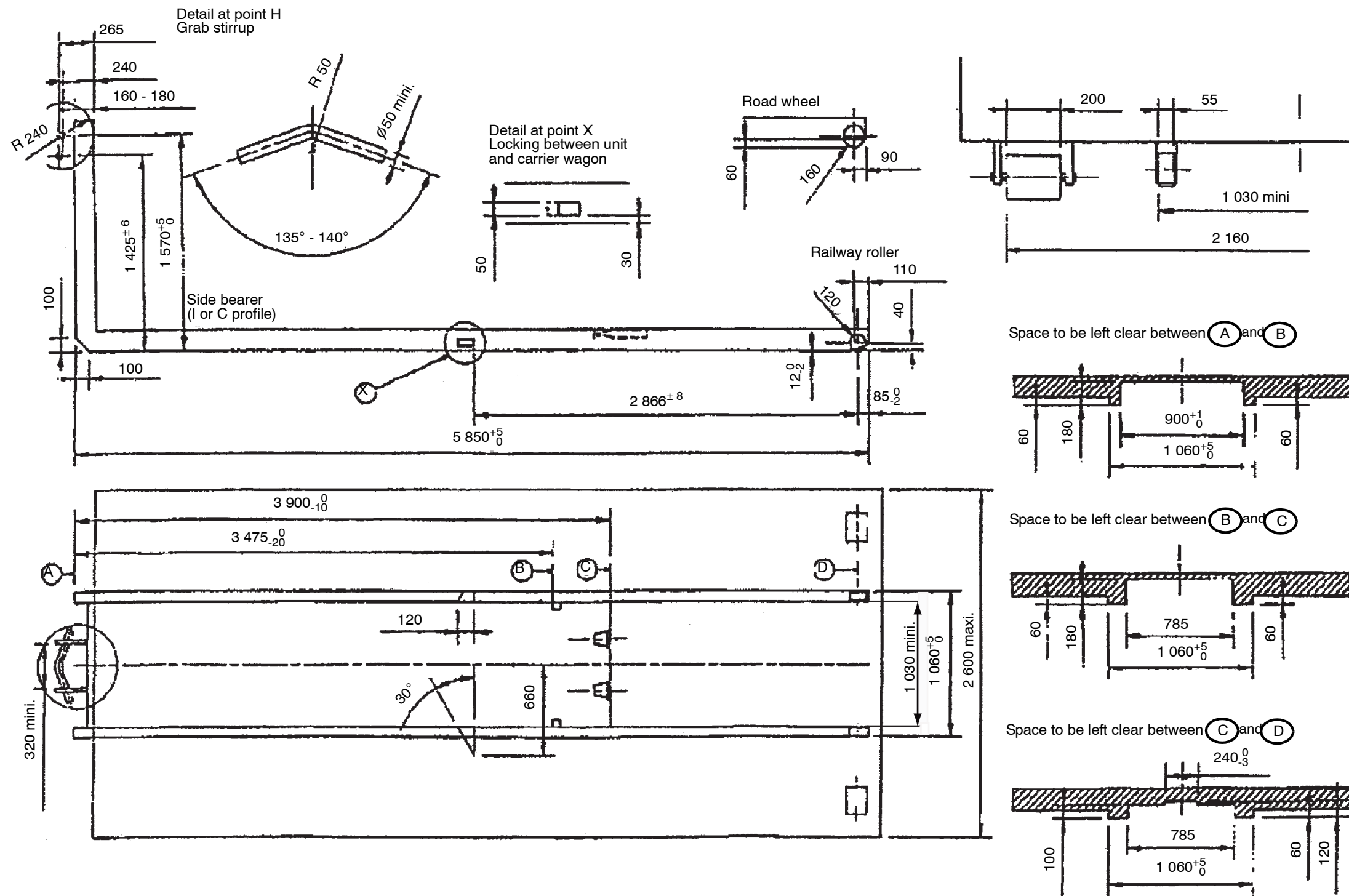

E.3 - RSS system

(see point 3.2.3 - page 11)

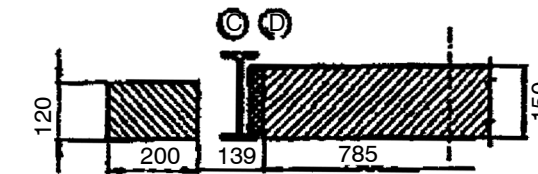
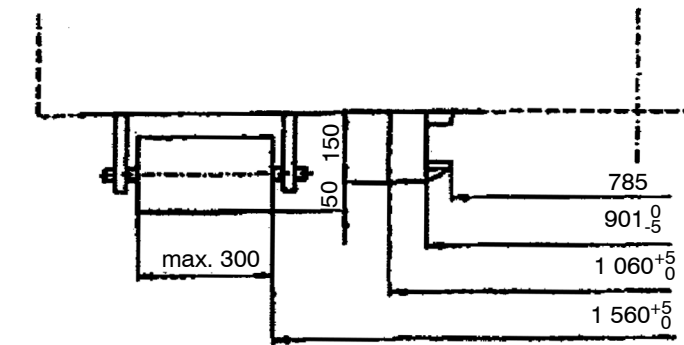
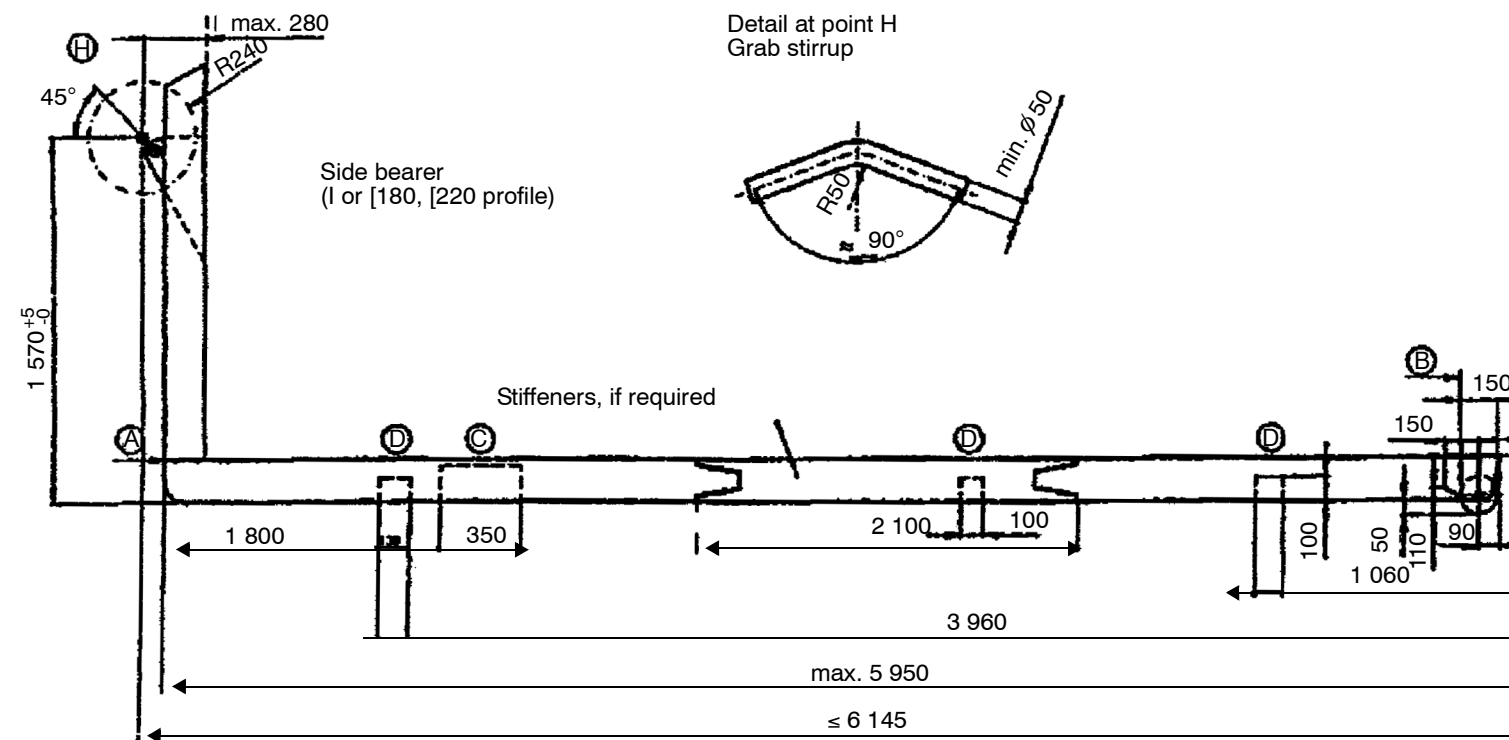

Space to be left clear between

(A) and (B)

except between

(C) and (D)

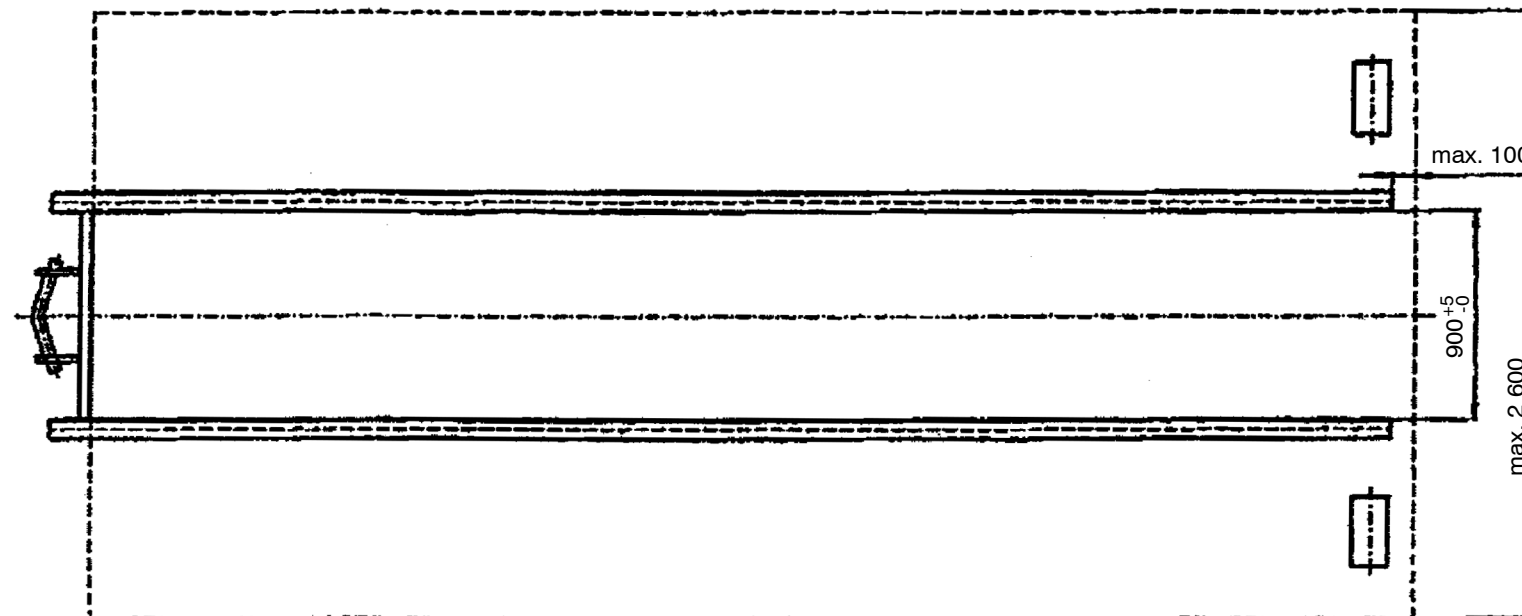

Appendix F - Compatibility diagrams

F.1 - SNCF ⇔ ACTS Compatibility

(see point 3.2.4.1 - page 11)

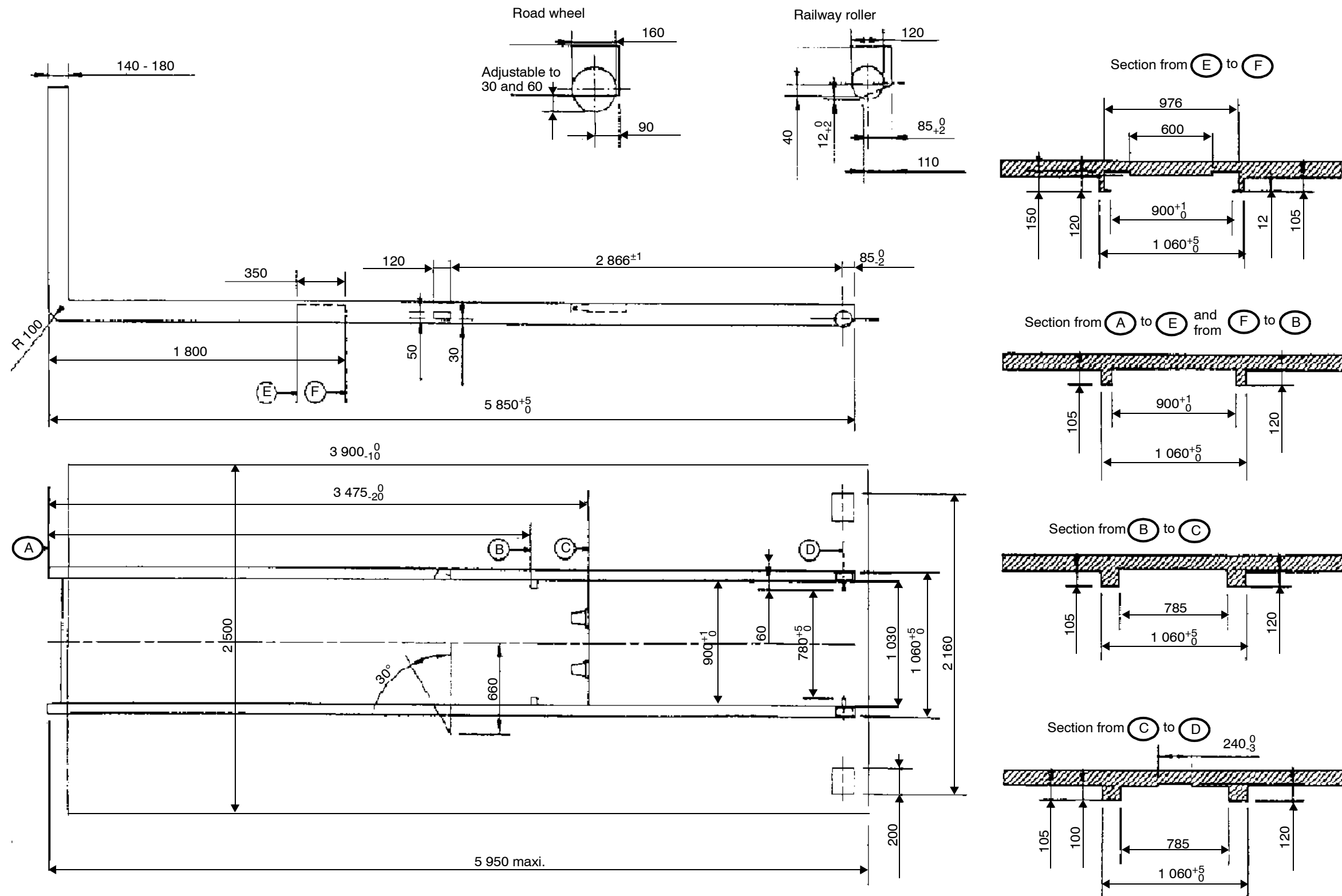

F.2 - ACTS ⇔ RSS Compatibility

(see point 3.2.4.2 - page 12)

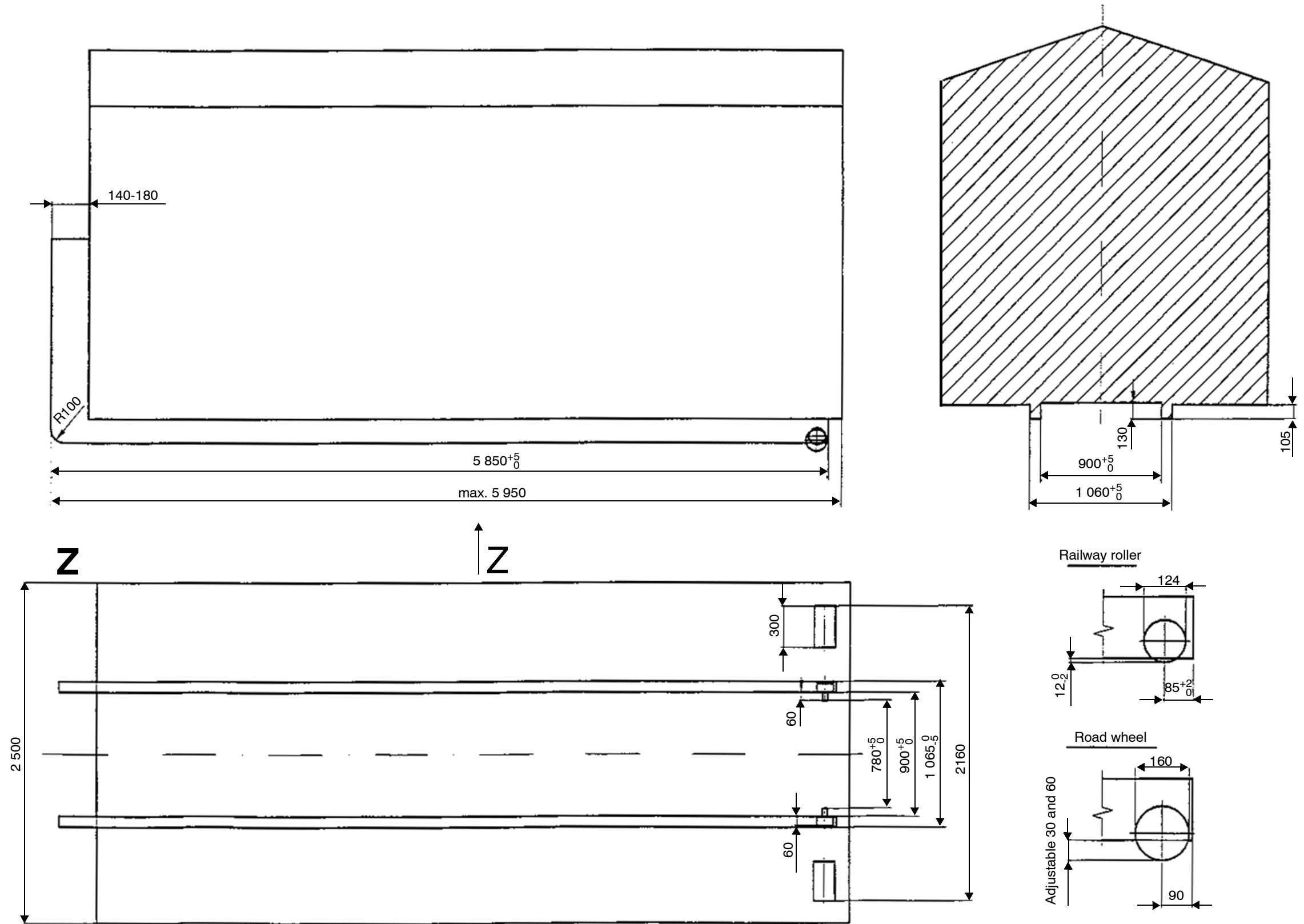

F.3 - SNCF ⇄ RSS Compatibility

(see point 3.2.4.3 - page 12)

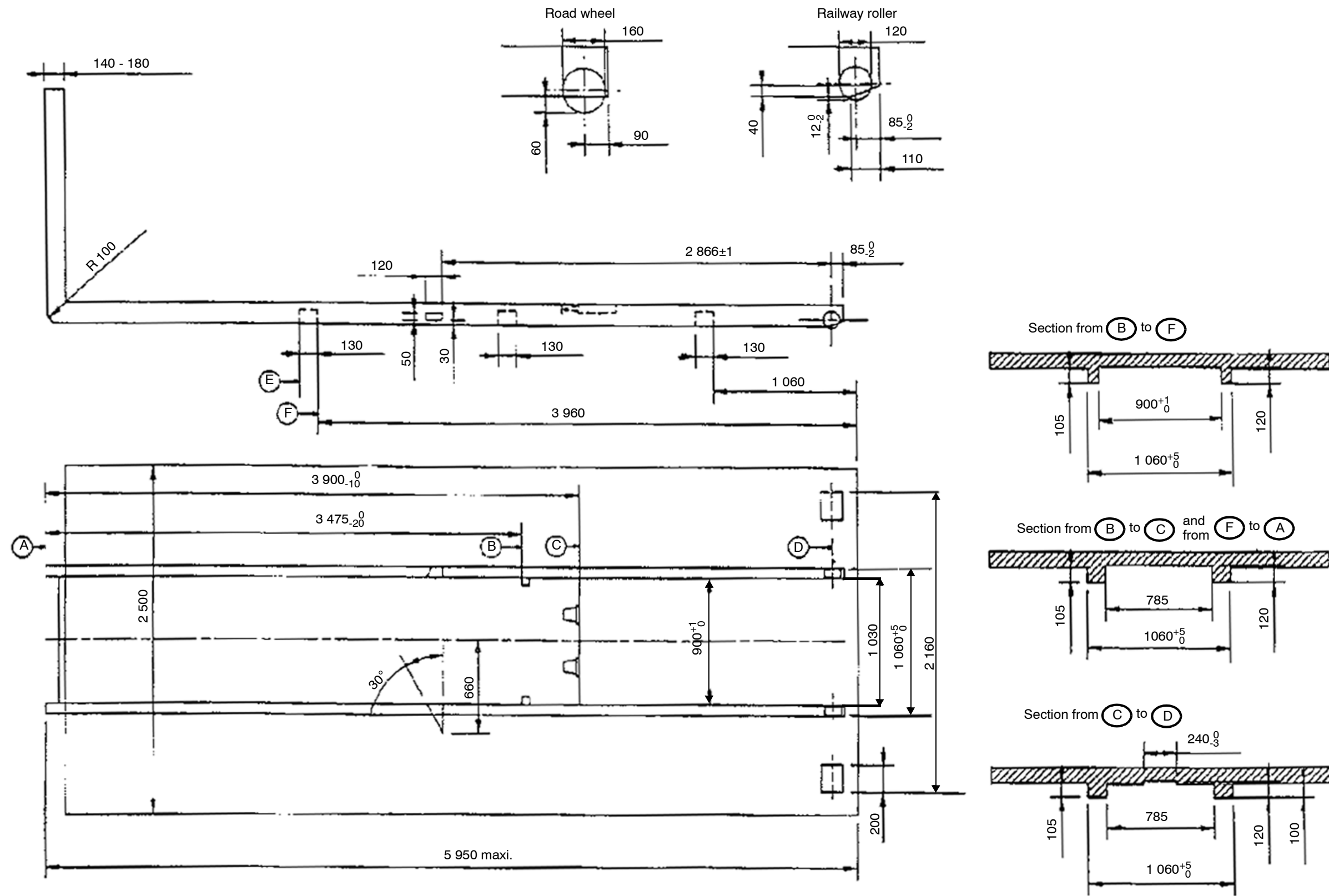

F.4 - ACTS ↔ RSS ↔ SNCF Compatibility

(see point 3.2.4.4 - page 12)

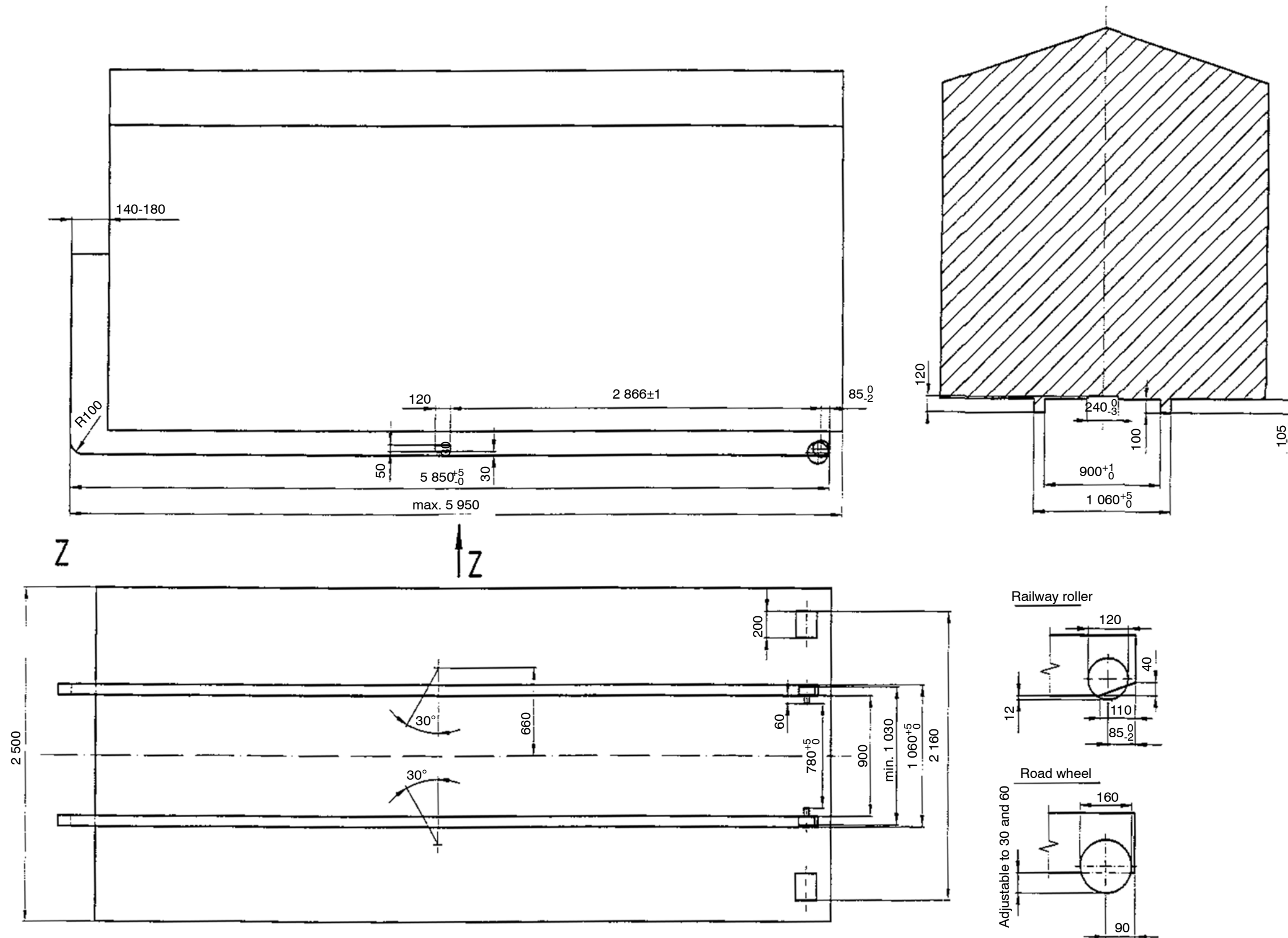

List of abbreviations

ATP

Automatic Train Protection

RIV

Agreement governing the exchange and use of wagons between Railway Undertakings (RIV 2000). Edition of 1.7.2000

Bibliography

1. UIC leaflets

Union Internationale des Chemins de fer (UIC)

UIC Leaflet 526-1: Wagons - Buffers with a stroke of 105 mm, 2nd edition, 01.07.98

UIC Leaflet 571-4: Standard wagons - Wagons for combined transport - Characteristics, 4th edition, October 2004

UIC Leaflet 577: Wagon stresses, 4th edition, December 2005

UIC Leaflet 592-2: Large containers for land transport. Technical conditions to be fulfilled by large containers for land transport accepted for use in international traffic, 6th edition, October 2004 (7th edition in preparation)

UIC Leaflet 592-3: Large containers and roll-off containers for horizontal transshipment. Standard report on acceptance tests, 2nd edition, 01.01.98

UIC Leaflet 592-4: Swap bodies for grab handling and spreader gripping - Technical conditions, 3rd edition, May 2007

UIC Leaflet 593: Privately-owned containers, transcontainers and "T" containers. Conditions of approval, 2nd edition of 01.01.70, reprint dated 01.04.81 incorporating Amendment 1

UIC Leaflet 596-6: Conveyance of road vehicles on wagons - Technical organisation. Conditions for coding load units in combined transport and combined transport lines, 5th edition, November 2006

Warning

No part of this publication may be copied, reproduced or distributed by any means whatsoever, including electronic, except for private and individual use, without the express permission of the International Union of Railways (UIC). The same applies for translation, adaptation or transformation, arrangement or reproduction by any method or procedure whatsoever. The sole exceptions - noting the author's name and the source - are "analyses and brief quotations justified by the critical, argumentative, educational, scientific or informative nature of the publication into which they are incorporated".

(Articles L 122-4 and L122-5 of the French Intellectual Property Code).

© International Union of Railways (UIC) - Paris, 2007

Printed by the International Union of Railways (UIC)
16, rue Jean Rey 75015 Paris - France, October 2007
Dépôt Légal October 2007

ISBN 2-7461-1183-7 (French version)
ISBN 2-7461-1184-5 (German version)
ISBN 2-7461-1185-3 (English version)